

AK Series Actuator Driver Manual

V1.0.8



CONTENT

Content-----	2
Notice-----	4
Feature-----	5
Disclaimer-----	5
Version Change Record-----	6
1. Drive Product Information-----	7
1.1 Introduction of Driver'appearance & Specifications -----	7
1.2 Drive Interface and Definition-----	8
1.2.1 Drive Interface Diagram-----	8
1.2.2 The Brand and Model of Drive Interface-----	8
1.2.3 Drive Interface Pin Definition-----	9
1.3 Drive Indicator Definition-----	9
1.4 Main Accessories and Specifications-----	10
2. R-link Produce Information-----	11
2.1 Introduction of R-link' Appearance & Specifications -----	11
2.2 R-link Interface and Definition-----	12
2.3 R-link Indicator Definition-----	13
3. Actuator and R-link Connection and Notices-----	13
4. Instructions for Use of the Upper Computer -----	14
4.1 PC Interface and Instruction-----	14
4.1.1 Home-----	15
4.2 Driveboard Calibration-----	21
4.2.1 Servo Mode-----	21
4.2.2 MIT Power Mode-----	22
4.3 Control Demo-----	23
4.3.1 Servo Mode-----	23
4.3.2 MIT Power Mode-----	28
4.4 Firmware Update-----	31

5. Driveboard Communication Protocol and Description-----	32
5.1 Servo Mode Control and Description-----	32
5.1.1 Duty Cycle Mode-----	34
5.1.2 Current Loop Mode-----	34
5.1.3 Current Brake Mode-----	35
5.1.4 Velocity Loop Mode-----	36
5.1.5 Position Loop Mode-----	37
5.1.6 Set Origin Mode-----	37
5.1.7 Position and Velocity Loop Mode -----	38
5.2 Motor Message Format under Servo Mode -----	39
5.3 MIT Power Mode Communication Protocol -----	40

Notice

1. Ensure that the circuit is normal and the interface is correctly connected as required.
2. The driver board will be hot when output, please use it carefully to avoid burns.
3. Please Check whether the parts are in good condition before use. If any parts are missing or aging, please stop using and contact technical support in time.
4. Several optional control modes can't be switched when driver board is working, and different control mode have different communication protocol. If you need to switch, please reboot the power to the driver board then to change. Using the wrong protocol control may burn the driver board.
5. Please use it strictly in accordance with the working voltage, current, temperature and other parameters specified in this article, otherwise it will cause permanent damage to the product.

Feature

The AK series actuators' driver board adopts the driver chip with high-performance, uses the Field Oriented Control (FOC) algorithm, and is equipped with advanced active disturbance rejection control technology to control the speed and angle. It is matched with our modular motor to form a powerful power package. It can be used with CubeMars Tool assistant software for parameter setting and firmware upgrade.

Disclaimer

Thank you for purchasing the AK series actuators. Before using, please read this statement carefully. Once used, it is deemed to be an endorsement and acceptance of the entire content of this statement. Please strictly abide by the product manual and related laws, regulations, policies and guidelines to install and use the product. In the process of using the product, the user promises to be responsible for his actions and all consequences arising therefrom.

CubeMars will not be liable for any losses caused by improper use, installation, or modification by the user.

CubeMars is a trademark of JIANGXI XINTUO ENTERPRISE CO., LTD and its affiliates. The product names, brands, etc. appearing in this article are the trademarks of their respective companies. This product and manual are copyrighted by JIANGXI XINTUO ENTERPRISE CO., LTD. Without

permission, it is not allowed to reproduce in any form. The final interpretation right of the disclaimer belongs to JIANGXI XINTUO ENTERPRISE CO., LTD.

Version Change Record

Date	Version	Change content
2021.9.1	Ver. 1.0.0	create version
2021.9.26	Ver.1.0.1	Correct the Can code of 5.3
2021.10.08	Ver.1.0.2	Change code of 5.1 and 5.2
2021.10.29	Ver.1.0.3	Correct data definitions of 5.1,5.2 and 5.3
2021.11.15	Ver.1.0.4	Added the message acceptance of 5.2 and 5.3
2021.11.24	Ver.1.0.5	UART protocol update of 5.2
2021.11.30	Ver.1.0.6	Add some information of 5.3
2022.01.20	Ver.1.0.7	Change the date of AK60-6's motor speed in 5.3
2022.02.24	Ver.1.0.8	Add the Servo Mode Serial Message Protocol in 5.2

1. Drive Product Information

1.1 Introduction of Drive' appearance & Specifications

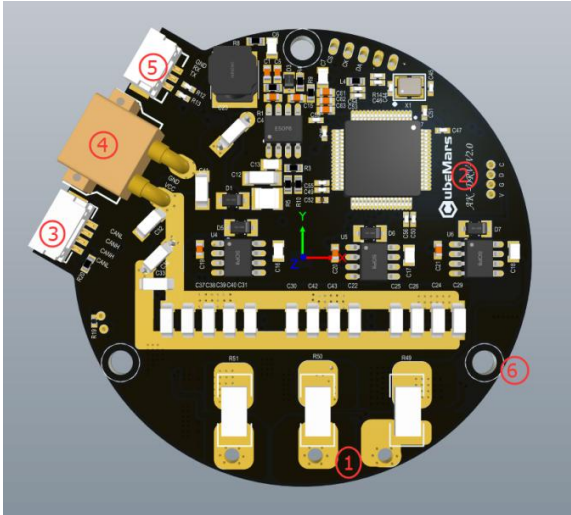

- ① Three-phase wires connection port
- ② Hardware version
- ③ CAN communication connection port
- ④ DC power port
- ⑤ Serial communication connection port
- ⑥ Mounting holes

Specifications	
Rated Voltage	48V
Peak Voltage	52V
Rated current	20A
Peak current	60A
Power consumption	≤50mA
Can bus bit rate	1Mbps (no change recommended)
Size	62mm×58mm
Working Environment temperature	-20℃-65℃
Maximum allowable temperature of driver board	100℃
Encoder Accuracy	14bit(single turn absolute)

1.2 Drive Interface and Definition

1.2.1 Drive Interface Diagram

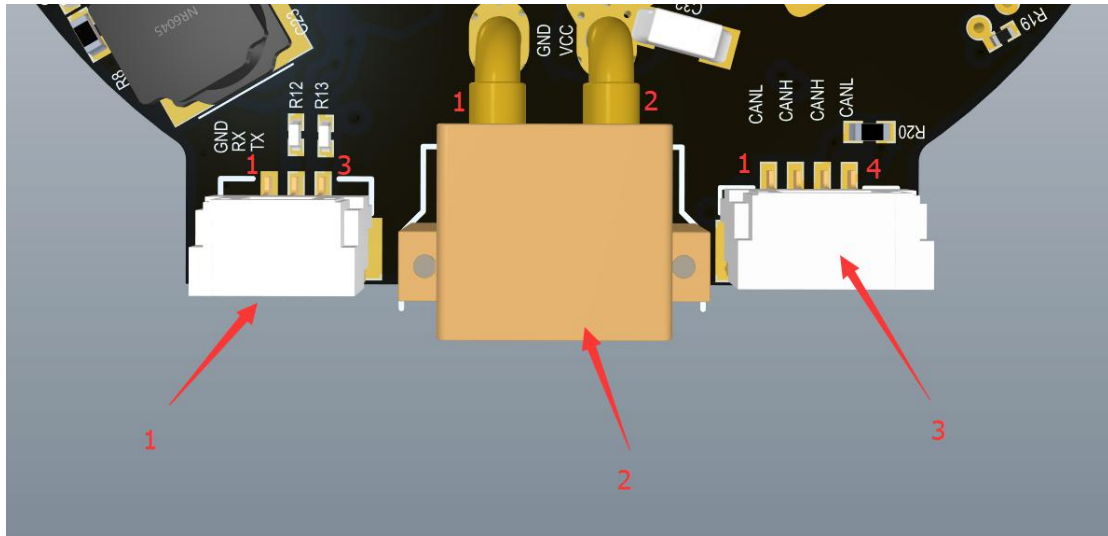

1.2.2 The Brand and Model of Drive Interface

No.	Onboard interface model	Brand	Wire interface model	Brand
1	A1257WR-S-3P	CJT	A1257H-3P	CJT
2	XT30PW-M	AMASS	XT30UPB-F	AMASS
3	A1257WR-S-4P	CJT	A1257H-4P	CJT

1.2.3 Drive Interface pin Definition

No.	Interface function	Pin	Explain
1	Serial communication	1	Serial signal ground (GND)

No.	Interface function	Pin	Explain
		2	Serial signal output (TX)
		3	Serial signal input (RX)
2	POWER INPUT	1	Negative pole (-)
		2	Positive pole (+)
3	Can communication	1	CAN communication low side (CAN_L)
		2	CAN communication high side (CAN_H)
		3	CAN communication high side (CAN_H)
		4	CAN communication low side (CAN_L)

1.3 Drive Indicator Definition

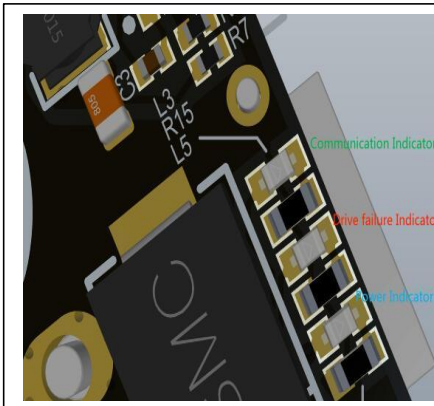

Indicator definition	
1. Power indicator (when blue light is on)	The power indicator is used to show the power supply of the driver board. Normally, it will light up blue when the power is plugged in. If the blue light is not on, please remove the power immediately and never turn on the power again.
2. Communication Indicator (when green light is on)	The communication indicator is used to show the communication status of the driver board. normally the driver board will light up green when the driver board communicates normally. If the green light is not on, please check whether the CAN communication wiring is normal.
3. Drive failure indicator (when red light is on)	The drive failure indicator is used to show the failure of the drive board. normally, it will light up in red only when the drive board fails, and it will usually go off under normal circumstances. When the drive failure indicator lights up, it means that the drive board has been damaged. The power supply should be turned off and no operation is allowed.

1.4 Main Accessories and Specifications

NO.	Item	Specification	QTY	Remark	
1	Serial communication line	wire rod	24AWG-300MM-Teflon silver-plated wire-black yellow green	Each 1PCS	±2MM
		pin	A1257H-3P	1PCS	
			A2541H-3P	1PCS	
2	power line	wire rod	16AWG-200MM-Silicone wire-red and black	Each 1PCS	±2MM
		pin	XT30UPB-M	1PCS	
			XT30UPB-F	1PCS	
3	CAN communication line	wire rod	24AWG-300MM-Teflon silver-plated wire-white and blue	Each 1PCS	±2MM
		pin	A1257H-4P	2PCS	
			A2541H-2P	1PCS	
4	Thermistor	MF51B103F3950-10K-3950	2PCS		
5	Electrolytic capacitor	120Uf-63V-10x12MM	2PCS	AK10-9 V2.0 standard	
6	MOS power	BSC026N08NS5-80V-2.6mΩ TPH2R608NH-75V-2.6mΩ	12PCS	Random	

2. R-link produce information

2.1 Introduction of R-link' appearance&Specifications

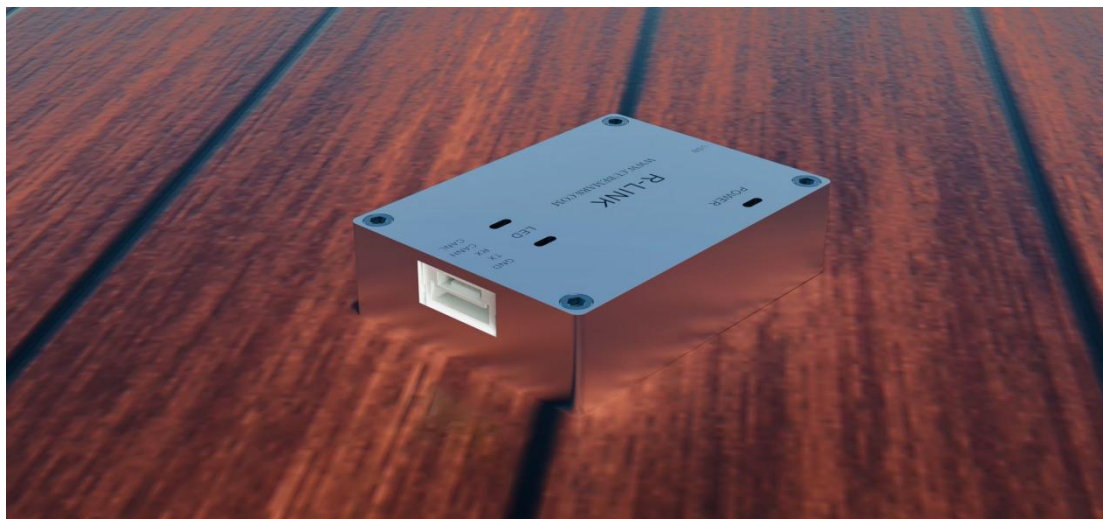

Specification	
Rated Voltage	5V
Power consumption	≤30mA
Size	39.2x29.2x10MM
Working Environment temperature	-20°C -65°C
Maximum allowable temperature of board	85°C

2.2 R-link Interface and Definition

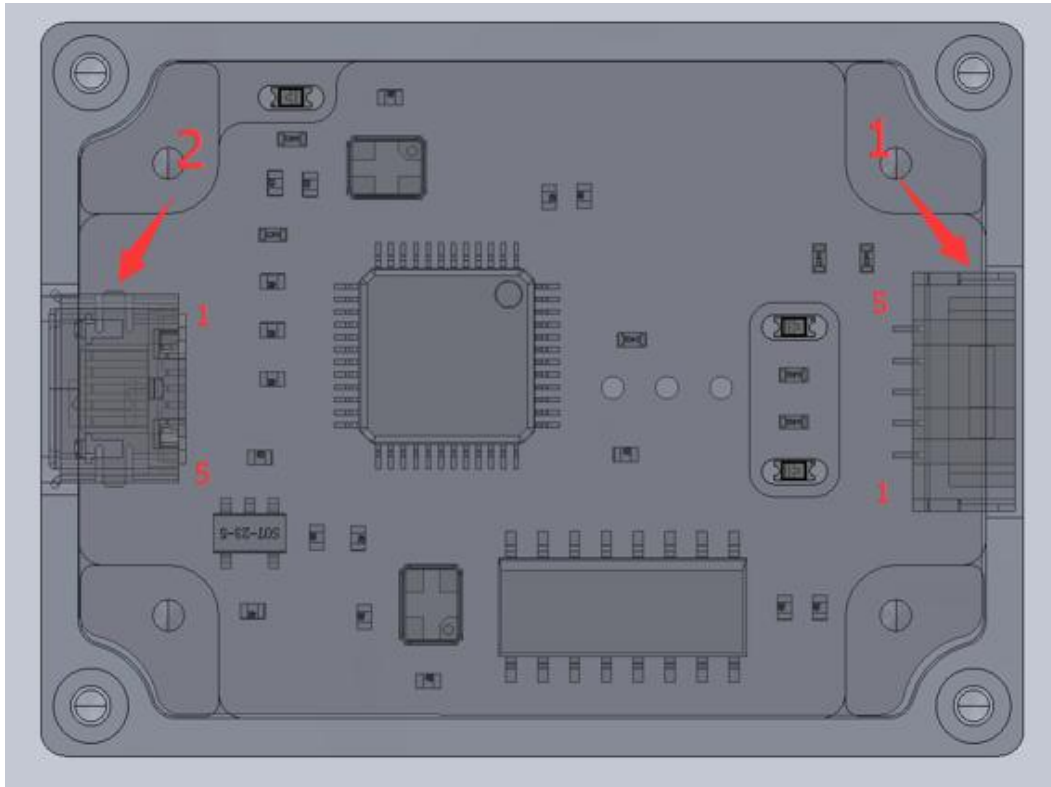

No.	Interface function	Pin	Definition
1	Communication Interface	1	CAN communication low side(CAN_L)
		2	CAN communication high side(CAN_H)
		3	Serial signal input (RX)
		4	Serial signal output (TX)
		5	Serial signal ground (GND)
2	USB interface	1	VBUS
		2	D-
		3	D+
		4	ID
		5	GND

2.3 R-link Indicator Definition

No.	Color	Definition
1	GREEN	The power indicator is used to indicate the power status of the R-link. Under normal circumstances, it will light up green when the power is plugged in. If the green light does not light up when the power is plugged in, please remove the power immediately and never turn on the power again
2	BLUE	Serial communication output (TX), always off, flashes when there is data output from the R-link serial port.
3	RED	Serial communication output (TX), always off, flashes when there is data input from the R-link serial port.

3. Actuator and R-link Connection and Notices

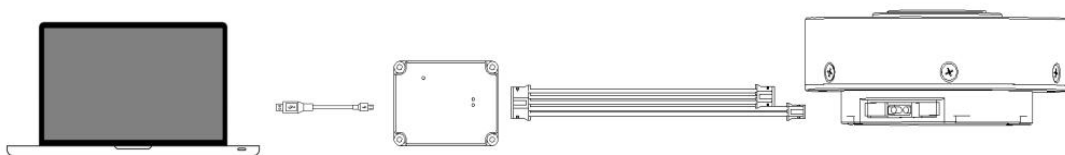

Connection instructions: Connect the USB cable to the PC and R-Link, the 5-Pin port to the R-Link port, the 4-Pin port to the CAN port of the motor, and the 3-Pin to the UART port of the motor.

4. Instructions for use of the upper computer

4.1 PC interface and instruction

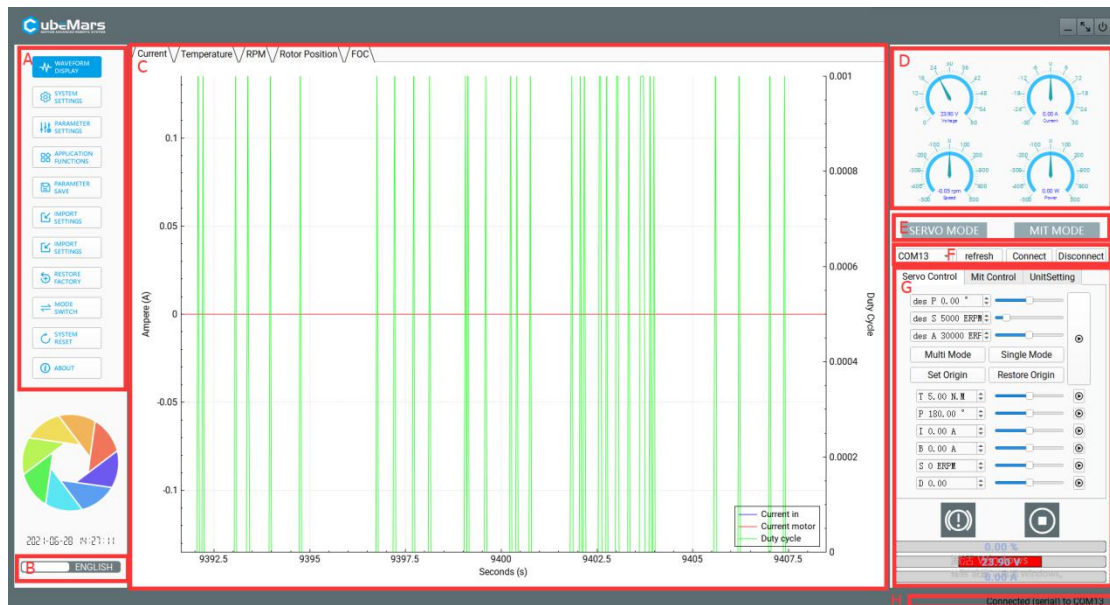

- A. Home
- B. Chinese and English Switching
- C. Main page
- D. Implement data display
- E. Current mode
- F. Serial port selection
- G. control parameter

4.1.1 Home

4.1.1.1 waveform display



This page supports viewing real-time data feedback and drawing images.

Data includes: motor current, temperature, real-time speed, inner encoder position, outer encoder position, high-frequency speed, rotor position, path planning, position deviation, DQ current, etc.

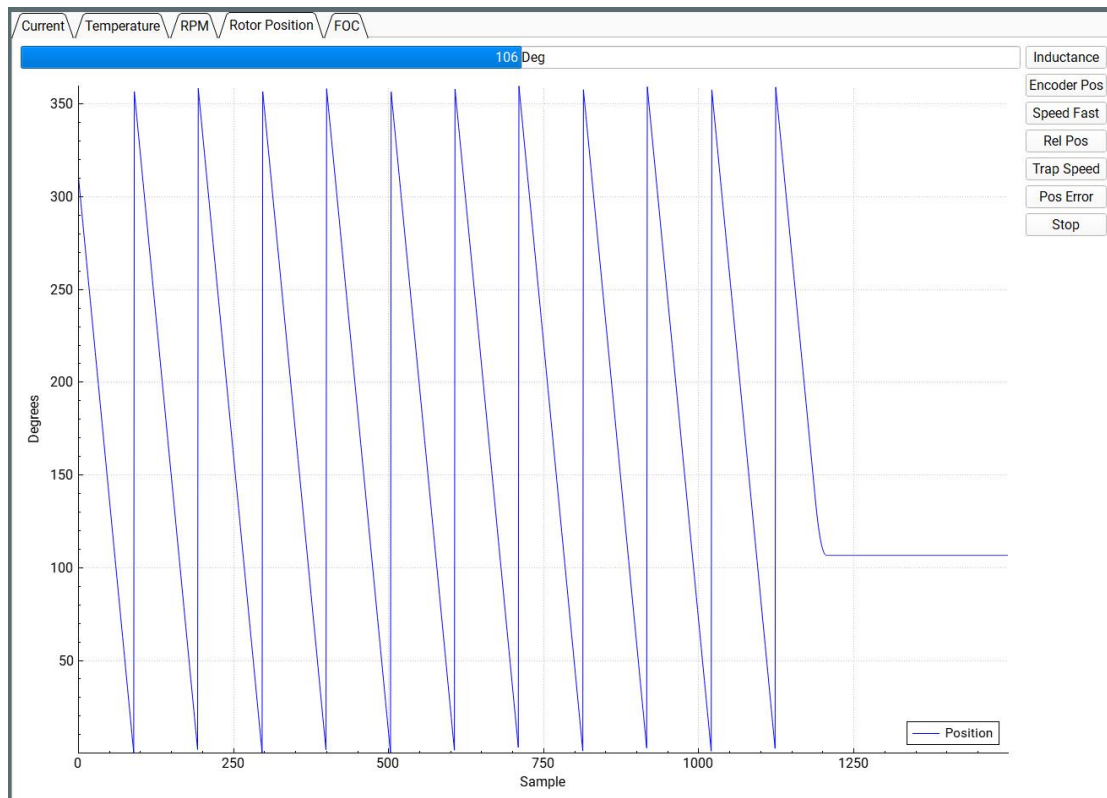

4.1.1.2 System Setting



This page is mainly about changing the hardware limitations of the drive board such as voltage, current, power, temperature, duty ratio, etc. It mainly protects the drive board and motors.

⚠ : Please use it strictly in accordance with the specified voltage, current, power, and temperature. Our company will not bear any legal responsibility if the operation of this product in violation of regulations causes injury to the human body or irreversible damage to the drive board and motor.

SERVO / MIT	
Hardware Limits	
Input Voltage Min	10.00 V
Input Voltage Max	60.00 V
Power Consumption Max	1500.00 W
Battery Low Level I	10.00 V
Battery Low Level II	9.00 V
Temperature Limits	
MOSFET Start	0.00 °C
MOSFET End	100.00 °C
Motor Start	85.00 °C
Motor End	100.00 °C
Other Limits	
Minimum duty cycle	0.005
Maximum duty cycle	0.950

4.1.1.3 Parameter Setting



This page is mainly about adjusting the parameters of the drive board, including but not limited to current loop Kp-Ki, encoder paranoia, maximum and minimum current, maximum and minimum speed, speed loop Kp-Ki-KD, reduction ratio and other parameters, as well as encoder calibration and motor parameter tuning.

⚠ : Please use it strictly in accordance with the specified voltage, current, power, and temperature. Our company will not bear any legal responsibility if the operation of this product in violation of regulations causes injury to the human body or irreversible damage to the drive board and motor.

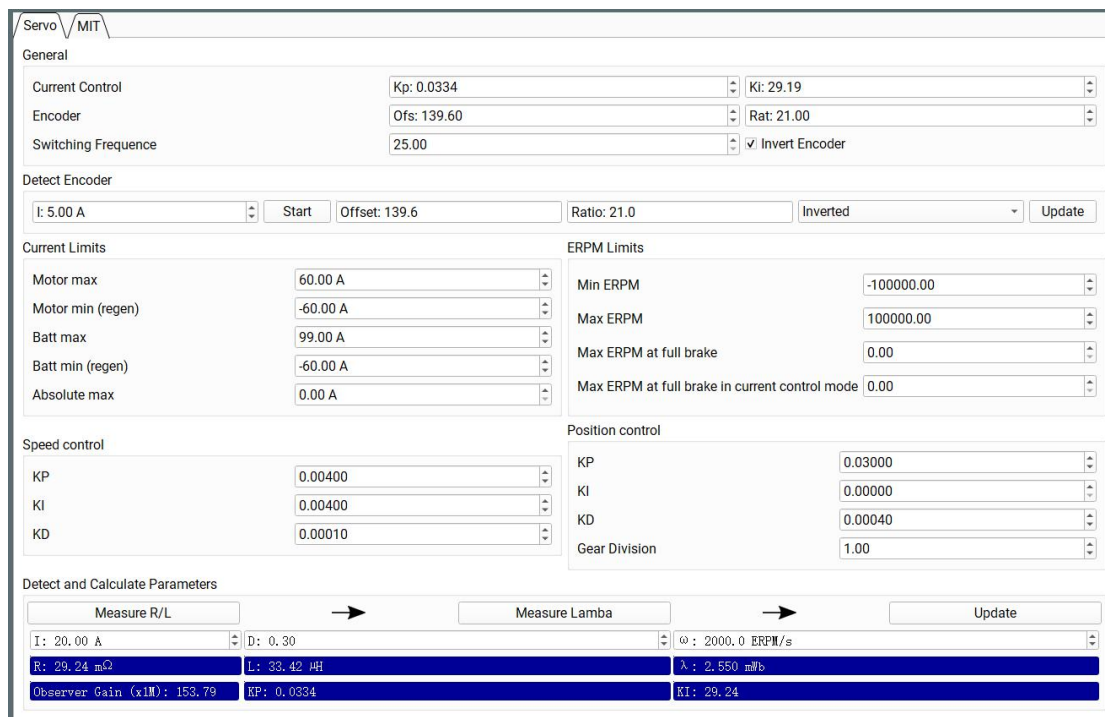

The screenshot shows a software interface for configuring a drive board. It is divided into several sections:

- General:**
 - Current Control: Kp: 0.0334, Ki: 29.19
 - Encoder: Ofs: 139.60, Rat: 21.00
 - Switching Frequency: 25.00, Invert Encoder
- Detect Encoder:**
 - I: 5.00 A, Start, Offset: 139.6, Ratio: 21.0, Inverted, Update
- Current Limits:**
 - Motor max: 60.00 A
 - Motor min (regen): -60.00 A
 - Batt max: 99.00 A
 - Batt min (regen): -60.00 A
 - Absolute max: 0.00 A
- ERPM Limits:**
 - Min ERPM: -100000.00
 - Max ERPM: 100000.00
 - Max ERPM at full brake: 0.00
 - Max ERPM at full brake in current control mode: 0.00
- Speed control:**
 - KP: 0.00400
 - KI: 0.00400
 - KD: 0.00010
- Position control:**
 - KP: 0.03000
 - KI: 0.00000
 - KD: 0.00040
 - Gear Division: 1.00
- Detect and Calculate Parameters:**
 - Buttons: Measure R/L, Measure Lambda, Update
 - Parameters: I: 20.00 A, D: 0.30, ω: 2000.0 ERPM/s
 - Results: R: 29.24 mΩ, L: 33.42 μH, λ: 2.550 mV/b, Observer Gain (x10): 153.79, KP: 0.0334, KI: 29.24

4.1.1.4 Application Functions



This page is mainly about CAN ID setting, CAN communication rate and CAN communication sudden interruption setting.

Settings		<input type="checkbox"/> Send status over CAN	
Controller ID	<input type="text" value="0"/>	Rate (Hz)	<input type="text" value="0"/>
Timeout (when no control signal is received)			
Timeout (ms)	<input type="text" value="0"/>		
Brake current to use when a timeout occurs (A)	<input type="text" value="0.00"/>		

4.1.1.5 Parameter Save



Save the upper computer parameters to the actuator.

4.1.1.6 Export Settings



Save the upper computer parameters as two files with the suffixes ".McParams" and ".AppParams" to the computer.



The ".McParams" file is:



The ".AppParams" file is:

4.1.1.7 Import Settings



Upload the parameters of the two files with the suffix ".McParams" and ".AppParams" on the computer to the upper computer.

4.1.1.8 Restore Factory



This feature is not currently enabled.

4.1.1.9 Mode Switch



This page is mainly about switching the control mode of the drive board, including "guide mode", "servo mode" and "MIT power mode", and update the driver board firmware.

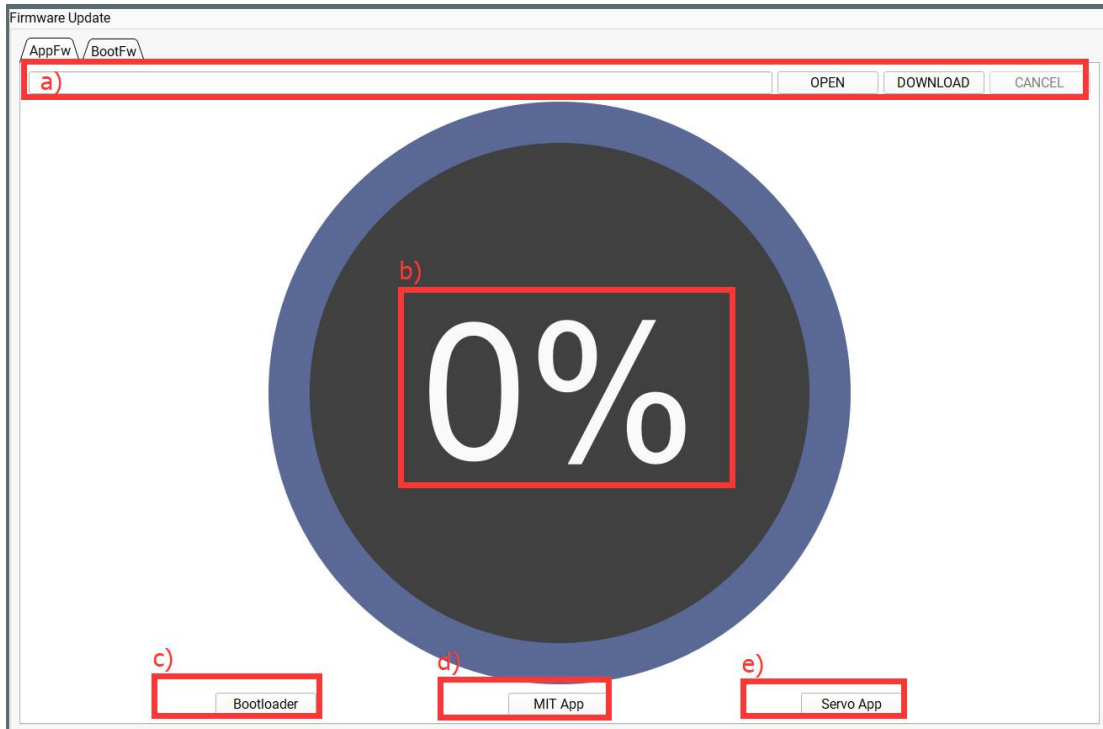

A). Import firmware area: It can import files with the suffix ".bin" in the computer.

B). Firmware update progress bar

C). Enter boot mode

D). Enter MIT power mode

E). Enter servo mode

4.1.1.10 System reset



Stop the actuator and reset.

4.1.1.11 About

About the version number of the host computer and the official website of the company <https://www.cubemars.com/>

4.2 Driver board calibration

After you reinstall the driver board on the motor, or change the line sequence of the motor's three-phase line, or update the firmware, you must calibrate it. After calibration, the motor can be used normally.

4.2.1 Servo mode

Confirm that the motor input power is stable, the R-LINK connection is normal, and the motor is in servo mode, after successfully connecting with the host computer, enter the system setting page, and click "Electrical Parameters", "Identification Parameters", "Update Parameters", "Start calibration", "Update parameters" successively.

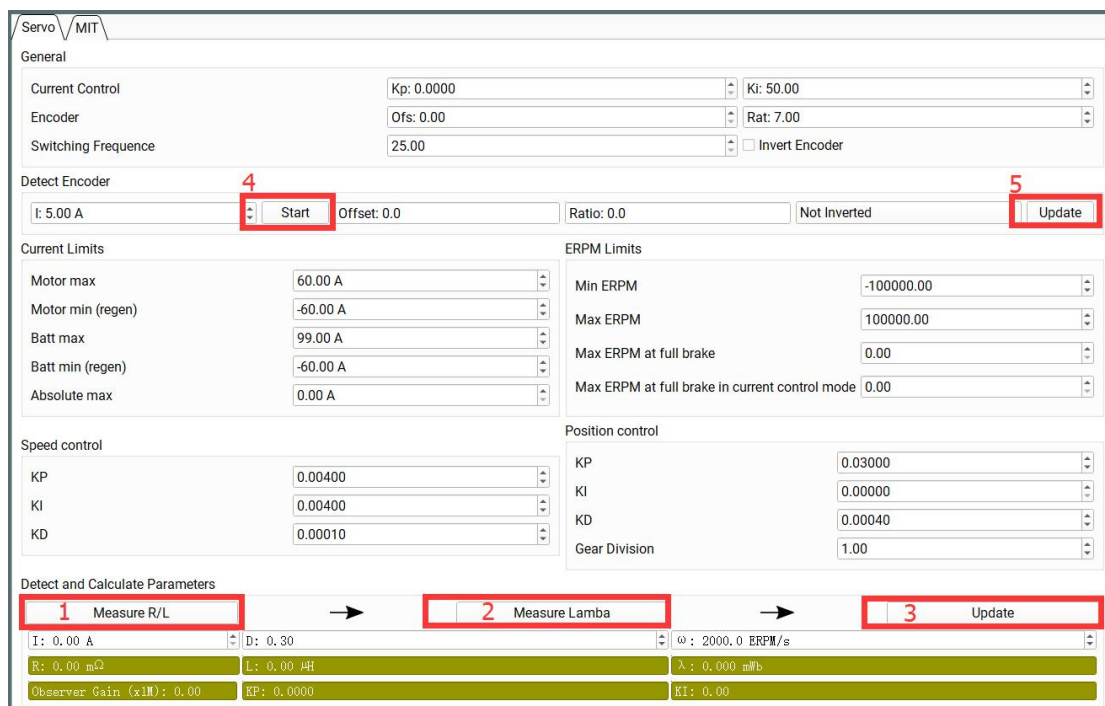

The screenshot displays the 'Servo' control software interface with the following sections and highlighted elements:

- General:**
 - Current Control: Kp: 0.0000, Ki: 50.00
 - Encoder: Ofs: 0.00, Rat: 7.00
 - Switching Frequency: 25.00, Invert Encoder
- Detect Encoder:**
 - I: 5.00 A, **4** Start, Offset: 0.0, Ratio: 0.0, Not Inverted, **5** Update
- Current Limits:**
 - Motor max: 60.00 A
 - Motor min (regen): -60.00 A
 - Batt max: 99.00 A
 - Batt min (regen): -60.00 A
 - Absolute max: 0.00 A
- ERPM Limits:**
 - Min ERPM: -100000.00
 - Max ERPM: 100000.00
 - Max ERPM at full brake: 0.00
 - Max ERPM at full brake in current control mode: 0.00
- Speed control:**
 - KP: 0.00400
 - KI: 0.00400
 - KD: 0.00010
- Position control:**
 - KP: 0.03000
 - KI: 0.00000
 - KD: 0.00040
 - Gear Division: 1.00
- Detect and Calculate Parameters:**
 - 1** Measure R/L → **2** Measure Lambda → **3** Update
 - I: 0.00 A, D: 0.30, ω: 2000.0 ERPM/s
 - R: 0.00 mΩ, L: 0.00 μH, λ: 0.000 mfb
 - Observer Gain (x1M): 0.00, KP: 0.0000, KI: 0.00

4.2.2 MIT power mode

Confirm that the motor input power is stable, the R-LINK connection is normal, and the motor is in force control mode, after successfully connecting with the host computer, click "Debug Mode" on the "Motion Control" interface, and then input "calibrate" in the input field, Wait for about 30 seconds. At the same time, the output field will scroll the position value of the encoder in real time until the output field prints "Encoder Electrical Offset (rad)", the actuator will reboot and print the message from the driver board then the calibration is completed. When calibrating, the voltage is about 1A at 48V, and the current is restored to about 0.02A after the calibration.



4.3 Control demo

4.3.1 Servo mode

4.3.1.1 Multi-turn position velocity mode

Confirm that the motor input power is stable, the R-LINK connection is normal, and the motor is in servo mode, after successfully connecting with the host computer, click "multi-turn mode" on the "servo control" interface, and input the desired position (the position at this time is ± 100 revolutions, is from -36000° to 36000°), after the desired speed and acceleration, the motor will move at the desired speed until it reaches the desired position.

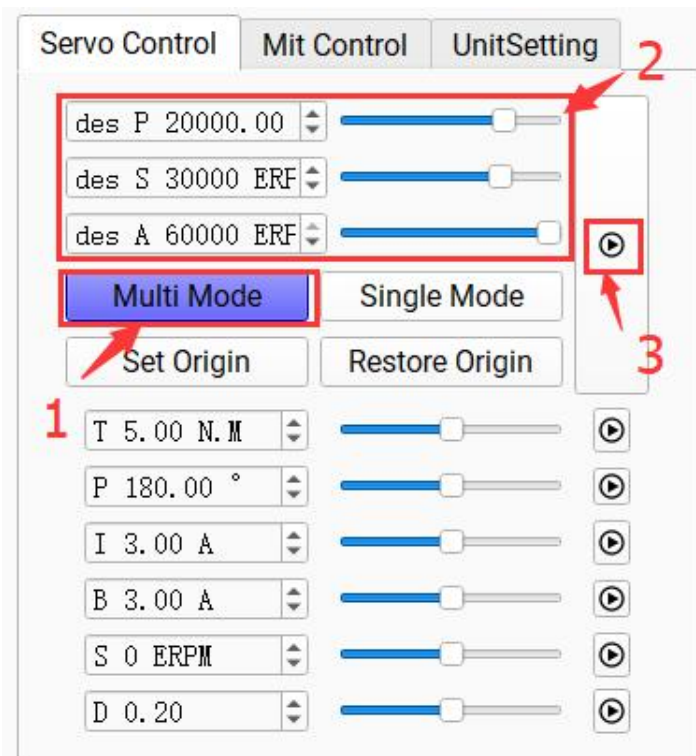

4.3.1.2 Single loop position velocity mode

Confirm that the motor input power is stable, the R-LINK connection is normal, and the motor is in servo mode, after successfully connecting with the host computer, click "single-turn mode" on the "servo control" interface, and after inputting the desired position (there is only one circle at this time, is from 0° to 359°), the desired speed and acceleration, the motor will move at the desired speed until it reaches the desired position.

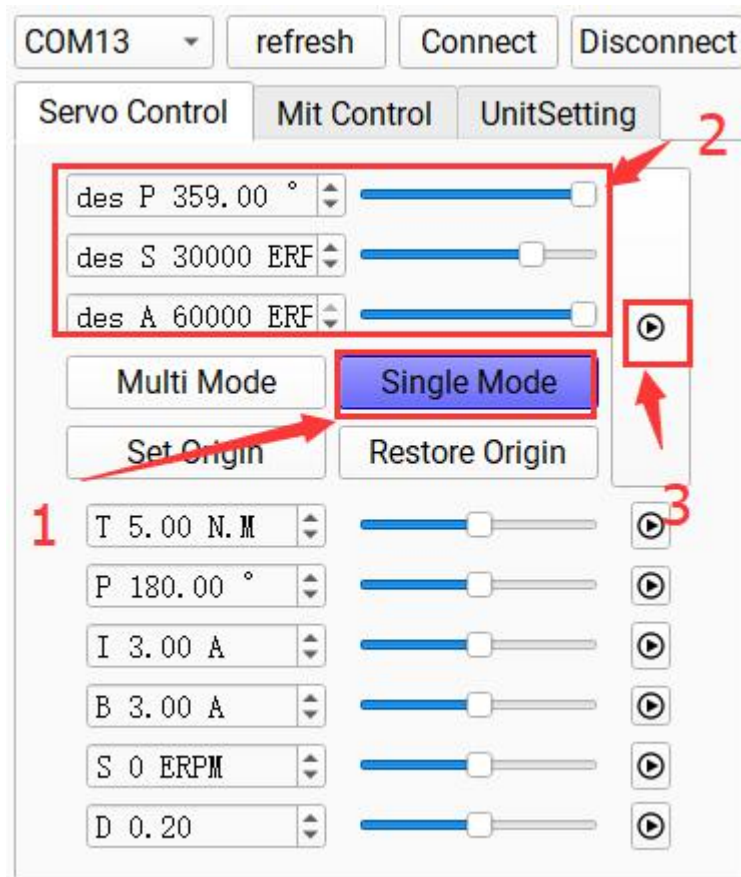

4.3.1.3 Position mode

Confirm that the motor input power is stable, the R-LINK connection is normal, and the motor is in servo mode, input the desired position in the "Servo Control" interface after connecting with the host computer successfully, and the motor will reach the desired position at the maximum speed.

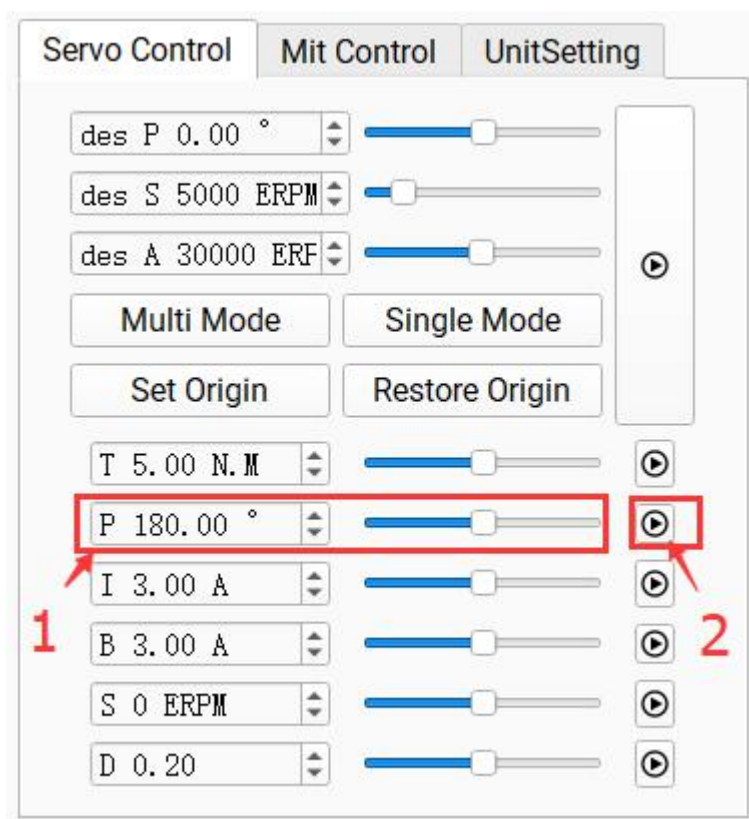

4.3.1.4 Velocity mode

Confirm that the motor input power is stable, the R-LINK connection is normal, and the motor is in servo mode, after connecting with the host computer successfully, input the desired speed (± 50000 ERPM) in the "Servo Control" interface, and the motor will move at the desired speed.

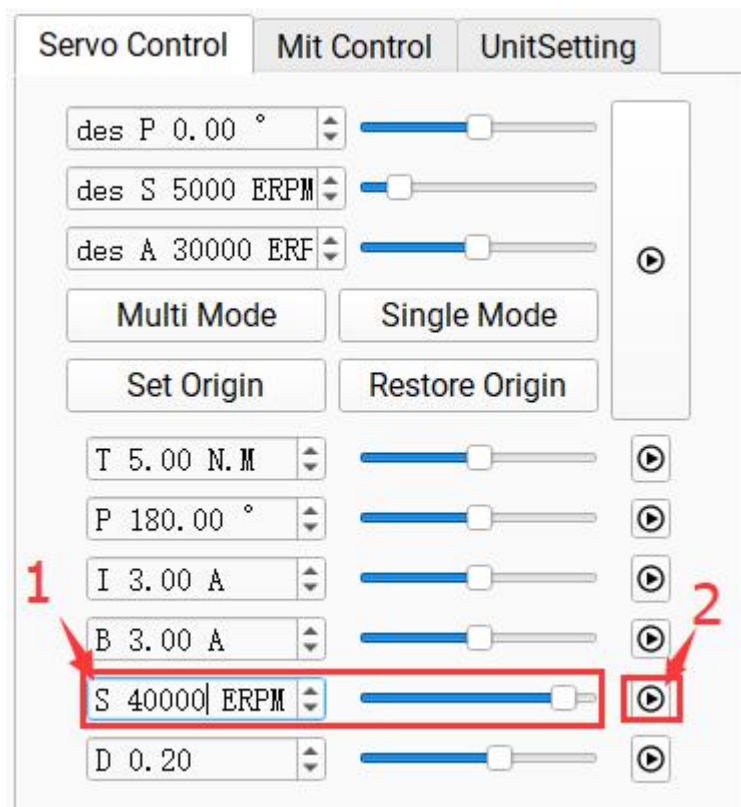

4.3.1.5 Duty cycle mode

Confirm that the motor input power is stable, the R-LINK connection is normal, and the motor is in servo mode, input the desired duty ratio (default 0.005-0.95) in the "Servo Control" after connecting with the host computer, the motor will work at the desired duty ratio.

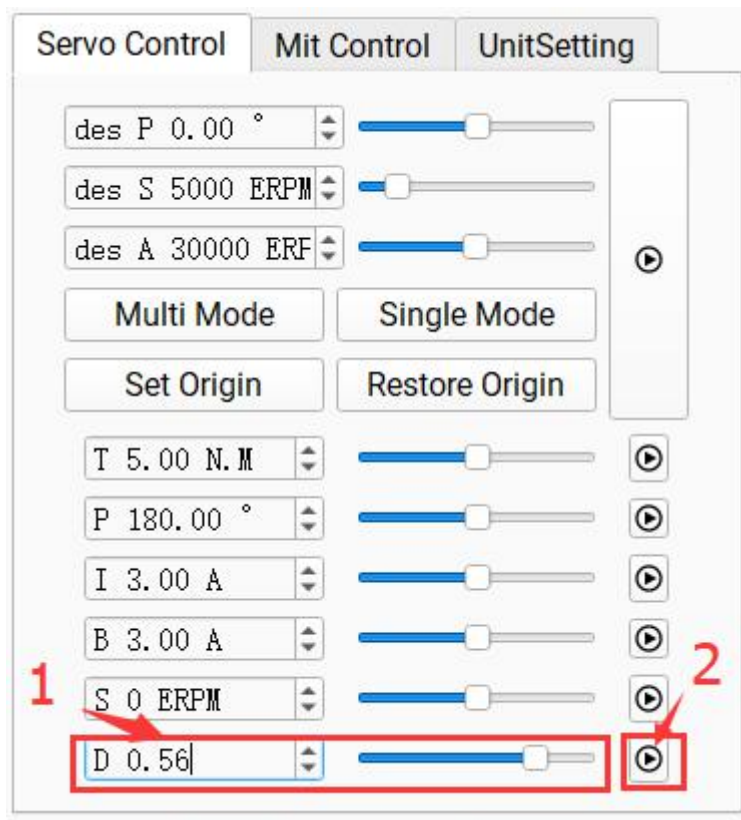

4.3.2 MIT power Mode

4.3.2.1 Position Mode

Confirm that the motor input power is stable, the R-LINK connection is normal, and the motor is in force control mode, after connecting with the host computer successfully, input corresponding “CAN ID” in the “Mit Control” interface and then click “RUN”, you can enter the motor mode. The motor will perform position movement (default speed 12000erpm, acceleration 40000erpm) after inputting desired position, KP and KD.

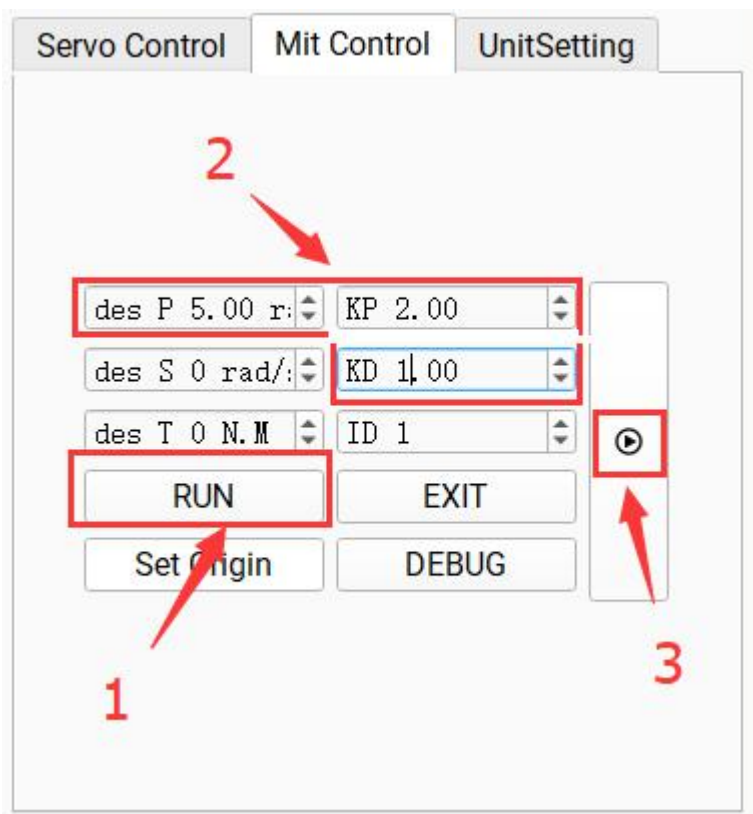

4.3.2.2 Velocity mode

Confirm that the motor input power is stable, R-Link connection is well, and the motor is in force control mode. After the motor is successfully connected with the upper computer, enter the corresponding "CAN ID" on the "Mit Control" interface and click "Enable Control" to enter the motor mode. After the expected speed and KD are input, the motor will running at speed.



4.3.2.3 Torque mode

Confirm that the motor input power is stable, R-Link connection is normal, and the motor is in force control mode. After the motor is successfully connected with the upper computer, enter the corresponding "CAN ID" on the "Mit Control" interface and click "Enable Control" to enter the motor mode. After the expected torque is input, the motor will running accord to the torque.

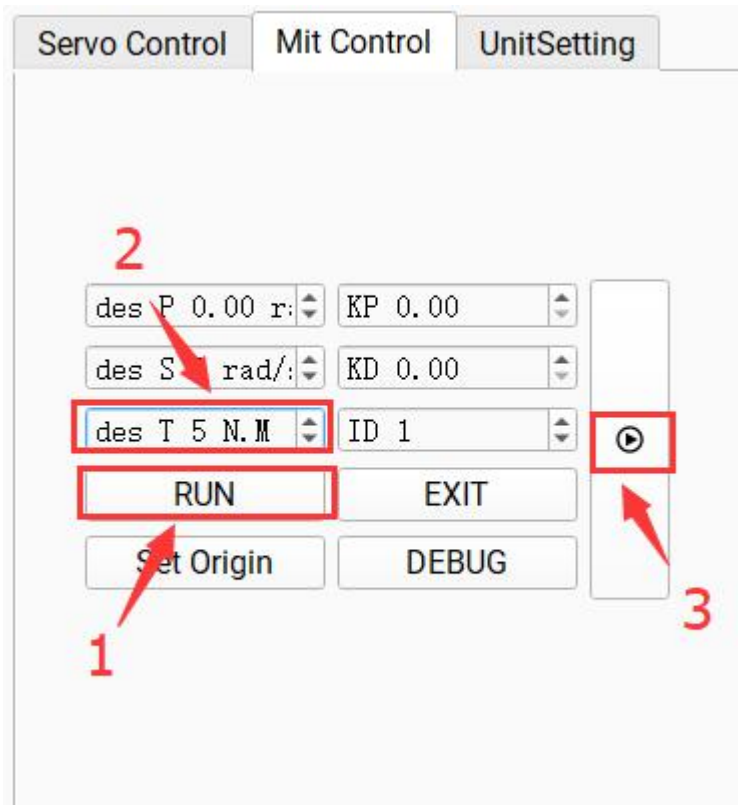

4.4 Firmware update

1. Click Open File and select the firmware. The firmware name extension is .bin.
2. Click Bootloader.
3. Click download and wait for the progress bar to reach 100%. Then restart the power supply.

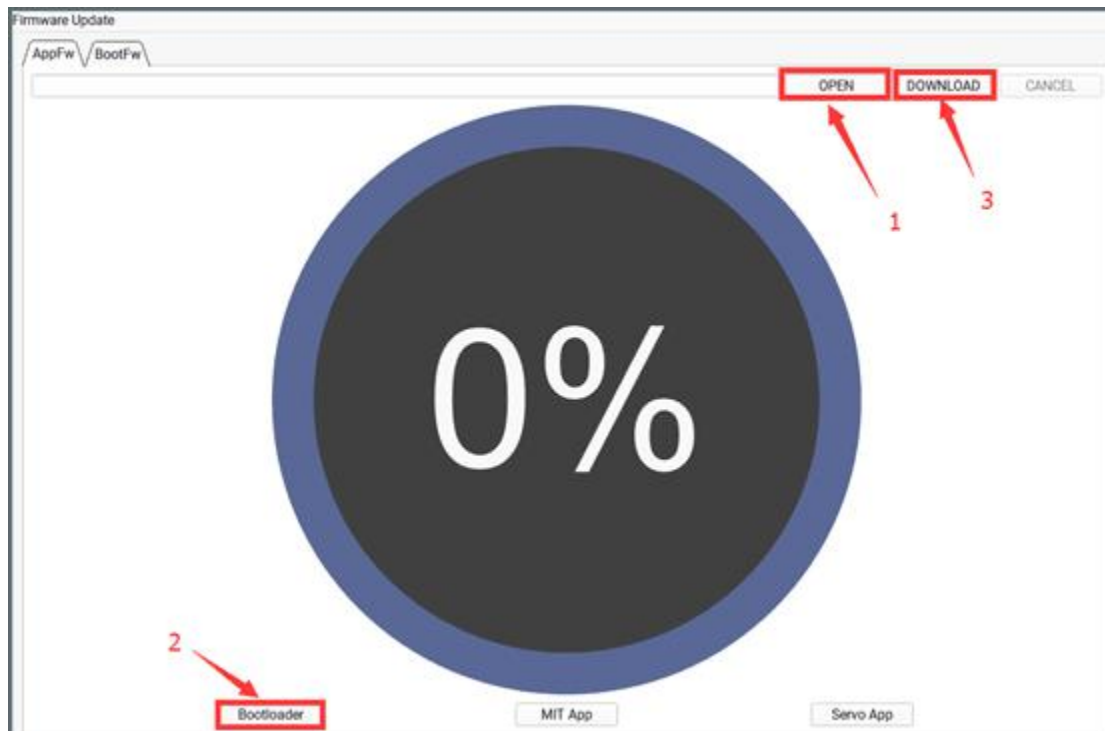

5. Driver board communication protocol and description

5.1 Servo mode and control mode description

Servo mode with six control modes

Duty cycle mode: duty cycle voltage is specified for a given motor, similar to square wave drive mode

Current loop mode: given the I_q current specified by the motor, the motor output torque = $I_q * K_T$, so it can be used as a torque loop

Current brake mode: the motor is fixed at the current position by the specified brake current given by the motor (pay attention to the motor temperature when using)

Velocity mode: the speed specified by the given motor

Position mode: Given the specified position of the motor, the motor will run to the specified position, (default speed 12000erpm acceleration 40000erpm)

Position velocity loop mode: the position, speed and acceleration specified by the given motor. The motor will run at a given acceleration and maximum speed to a specified position.

The servo motor protocol is CAN protocol, and the extended frame format is shown below

Can ID bits	[28]-[8]	[7]-[0]
Field name	Control mode	Source node ID

Control mode contain {0,1,2,3,4,5,6,7} Seven eigenvalues correspond to seven control modes respectively

Duty cycle mode: 0

Current loop mode: 1

Current brake mode: 2

Velocity mode: 3

Position mode: 4

Set origin mode:5

Position velocity loop mode: 6

Examples of various mode control motors are provided below

The following are library functions and macro definitions for each instance

```
typedef enum {
    typedef enum {
        CAN_PACKET_SET_DUTY = 0, //Duty cycle mode
        CAN_PACKET_SET_CURRENT, //Current loop mode
```



```
CAN_PACKET_SET_CURRENT_BRAKE, // Current brake mode
CAN_PACKET_SET_RPM,           //Velocity mode
CAN_PACKET_SET_POS,           // Position mode
CAN_PACKET_SET_ORIGIN_HERE,   //Set origin mode
CAN_PACKET_SET_POS_SPD,       //Position velocity loop mode
} CAN_PACKET_ID;

void comm_can_transmit_eid(uint32_t id, const uint8_t *data, uint8_t len) {
    uint8_t i=0;
    if (len > 8) {
        len = 8;
    }
    CanTxMsg TxMessage;
    TxMessage.StdId = 0;
    TxMessage.IDE = CAN_ID_EXT;
    TxMessage.ExtId = id;
    TxMessage.RTR = CAN_RTR_DATA;
    TxMessage.DLC = len;
    //memcpy(txmsg.data8, data, len);
    for(i=0;i<len;i++)
    TxMessage.Data[i]=data[i];
    CAN_Transmit(CHASSIS_CAN, &TxMessage);
}

void buffer_append_int32(uint8_t* buffer, int32_t number, int32_t *index) {
    buffer[(*index)++] = number >> 24;
    buffer[(*index)++] = number >> 16;
    buffer[(*index)++] = number >> 8;
    buffer[(*index)++] = number;
}

void buffer_append_int16(uint8_t* buffer, int16_t number, int16_t *index) {
    buffer[(*index)++] = number >> 8;
    buffer[(*index)++] = number;
}
```

5.1.1 Duty cycle mode:

Duty cycle mode sends data definitions

Data bits	Data[3]	Data[2]	Data[1]	Data[0]
Range	0~0xff	0~0xff	0~0xff	0~0xff
Corresponding variables	Duty cycle 25-32 bit	Duty cycle 17-24 bit	Duty cycle 9-16 bit	Duty cycle 1-8 bit

```
void comm_can_set_duty(uint8_t controller_id, float duty) {
    int32_t send_index = 0;
    uint8_t buffer[4];
    buffer_append_int32(buffer, (int32_t)(duty * 100000.0), &send_index);
    comm_can_transmit_eid(controller_id | ((uint32_t)CAN_PACKET_SET_DUTY << 8), buffer,
    send_index);
}
```

5.1.2 Current loop mode

Current loop mode sends data definition

Data bits	Data[3]	Data[2]	Data[1]	Data[0]
Range	0~0xff	0~0xff	0~0xff	0~0xff
Corresponding variables	Current 25-32 bit	Current 17-24 bit	Current 9-16 bit	Current 1-8 bit

Among them, the current value is of int32 type, and the value -60000-60000 represents -60-60A.

Current loop mode sending routine

```
void comm_can_set_current(uint8_t controller_id, float current) {
    int32_t send_index = 0;
    uint8_t buffer[4];
    buffer_append_int32(buffer, (int32_t)(current * 1000.0), &send_index);
    comm_can_transmit_eid(controller_id |
        ((uint32_t)CAN_PACKET_SET_CURRENT << 8), buffer, send_index);
}
```

5.1.3 Current Brake Mode

Current brake mode sends data definition

Data bits	Data[3]	Data[2]	Data[1]	Data[0]
Range	0~0xff	0~0xff	0~0xff	0~0xff
Corresponding variables	Brake current 25-32 bit	Brake current 17-24 bit	Brake current 9-16 bit	Brake current 1-8 bit

Among them, the braking current value is of int32 type, and the value 0-60000 represents 0-60A.

Current brake mode sending routine

```
void comm_can_set_cb(uint8_t controller_id, float current) {
    int32_t send_index = 0;
    uint8_t buffer[4];
    buffer_append_int32(buffer, (int32_t)(current * 1000.0), &send_index);
    comm_can_transmit_eid(controller_id |
        ((uint32_t)CAN_PACKET_SET_CURRENT_BRAKE << 8), buffer, send_index);
}
```

5.1.4 Velocity mode

Velocity loop simple control block diagram

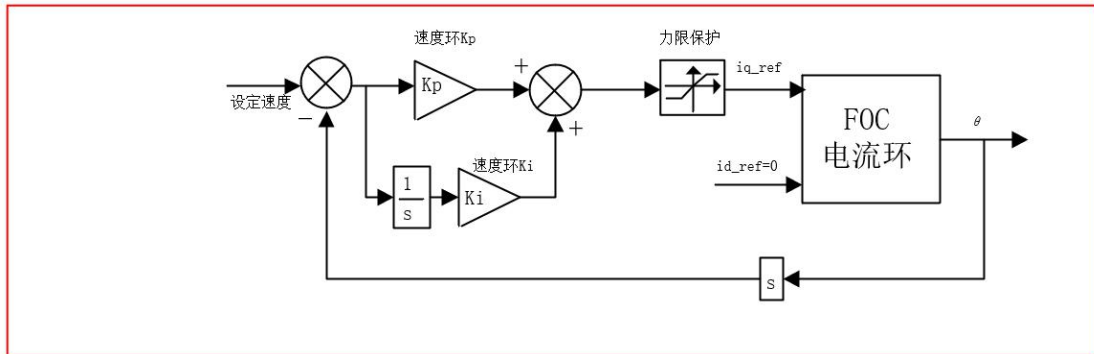

Velocity loop mode sends data definition

Data bits	Data[3]	Data[2]	Data[1]	Data[0]
Range	0~0xff	0~0xff	0~0xff	0~0xff
Corresponding variables	Speed 25-32 bit	Speed 17-24 bit	Speed 9-16 bit	Speed 1-8 bit

Among them, the speed value is int32 type, and the range -100000-100000 represents -100000-100000 electrical speed.

Velocity loop sending routine

```
void comm_can_set_rpm(uint8_t controller_id, float rpm) {
    int32_t send_index = 0;
    uint8_t buffer[4];
    buffer_append_int32(buffer, (int32_t)rpm, &send_index);
    comm_can_transmit_eid(controller_id |
        ((uint32_t)CAN_PACKET_SET_RPM << 8), buffer, send_index);
}
```

5.1.5 Position loop mode

Position loop simple control block diagram

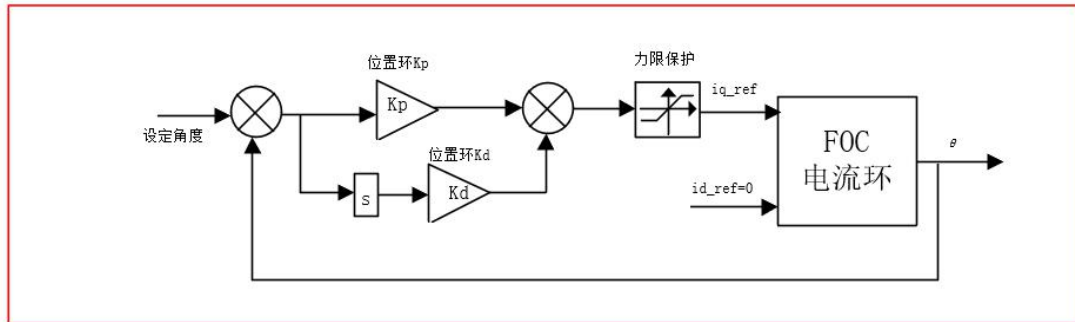

Position loop mode sends data definitions

Data bits	Data[3]	Data[2]	Data[1]	Data[0]
Range	0~0xff	0~0xff	0~0xff	0~0xff
Corresponding variables	Position 25-32 bit	Position 17-24 bit	Position 9-16 bit	Position 1-8 bit

Position loop sending routine, position as int32 type, range-360000000~360000000 represents position $-36000^{\circ} \sim 36000^{\circ}$

```
void comm_can_set_pos(uint8_t controller_id, float pos) {
    int32_t send_index = 0;
    uint8_t buffer[4];
    buffer_append_int32(buffer, (int32_t)(pos * 1000000.0), &send_index);
    comm_can_transmit_eid(controller_id |
        ((uint32_t)CAN_PACKET_SET_POS << 8), buffer, send_index);
}
```

5.1.6 Set origin mode

Date bits	Data[0]
Range	0~0x02
Corresponding variable	Set instruction

Among them, the setting command is uint8_t type, 0 means setting the temporary origin (power failure elimination), 1 means setting the permanent zero point (automatic parameter saving), 2

means restoring the default zero point (automatic parameter saving);

Position loop sending routine

```
void comm_can_set_origin(uint8_t controller_id, uint8_t set_origin_mode) {
    comm_can_transmit_eid(controller_id |
        ((uint32_t) CAN_PACKET_SET_ORIGIN_HERE << 8), buffer, send_index);
}
```

5.1.7 Position and Velocity Loop Mode

Simplified block diagram of position velocity loop

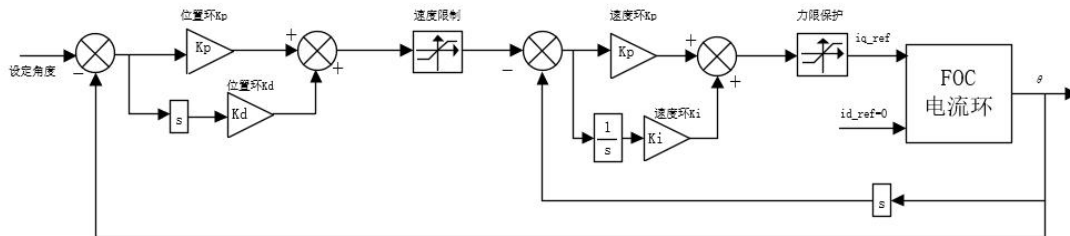

Position velocity loop mode sends data definition

Data bits	Data[0]	Data[1]	Data[2]	Data[3]	Data[4]	Data[5]	Data[6]	Data[7]
Range	0~0xff	0~0xff	0~0xff	0~0xff	0~0xff	0~0xff	0~0xff	0~0xff
Corresponding variables	Position 25-32 bit	Position 17-24 bit	Position 9-16 bit	Position 1-8 bit	Speed 8 bit high	Speed 8 bit low	Accelerated speed 8 bit high	Accelerated speed 8 bit low

Among them, the position is int32 type, and the range -360000000-360000000 represents the position -36000°-36000°;

Among them, the speed is int16 type, and the range -100000-100000 represents -100000-100000 electrical speed;

Among them, the acceleration is int16 type, and the range -100000-100000 represents -100000-100000 electrical speed/s².

```
void comm_can_set_pos_spd(uint8_t controller_id, float pos, int16_t spd, int16_t RPA ) {
    int32_t send_index = 0;
    int16_t send_index1 = 0;
    uint8_t buffer[4];
    buffer_append_int32(buffer, (int32_t)(pos * 10000.0), &send_index);
```

```

buffer_append_int16(buffer,spd, & send_index1);
buffer_append_int16(buffer,RPA, & send_index1);
    comm_can_transmit_eid(controller_id |
        ((uint32_t)CAN_PACKET_SET_POS << 8), buffer, send_index);
}

```

5.2 Servo mode of motor message format

5.2.1 Servo mode CAN upload message protocol

In servo mode, motor packets are uploaded in timing mode. The upload frequency can be set to 1-500Hz, and the upload byte is 8 bytes

Data bits	Data[0]	Data[1]	Data[2]	Data[3]	Data[4]	Data[5]	Data[6]	Data[7]
Range	0~0xff	0~0xff	0~0xff	0~0xff	0~0xff	0~0xff	0~0xff	0~0xff
Corresponding variables	Position 8 bit high	Position 8 bit low	Speed 8 bit high	Speed 8 bit low	Current 8 bit high	Current 8 bit low	Motor temperature	An error code

Among them, the position is int16 type, and the range -32000-32000 represents the position -3200° -3200° ;

Among them, the speed is int16 type, and the range -32000-32000 represents -320000-320000rpm electrical speed;

Among them, the current is of type int16, and the value -6000-6000 represents -60-60A

Among them, the temperature is int8 type, and the range of -20-127 represents the temperature of the driver board: -20°C-127°C;

Among them, the error code is uint8 type, 0 means no fault, 1 means over temperature fault, 2 means over current fault, 3 means over voltage fault, 4 means under voltage fault, 5 means encoder fault, 6 means phase current unbalance fault (The hardware may be damaged);

The following is an example of message acceptance

```

void motor_receive(float* motor_pos,float*
motor_spd,float* cur,int_8* temp,int_8* error,rx_message)
{
    int16_t pos_int = (rx_message)->Data[0] << 8 | (rx_message)->Data[1]);
    int16_t spd_int = (rx_message)->Data[2] << 8 | (rx_message)->Data[3]);
    int16_t cur_int = (rx_message)->Data[4] << 8 | (rx_message)->Data[5]);
    &motor_pos= (float)( pos_int * 0.1f); //motor position

```

```

&motor_spd= (float)( spd_int * 10.0f); //motor speed
&motor_cur= (float) ( cur_int * 0.01f); //motor current
&motor_temp= (rx_message)->Data[6] ; //motor temperature
&motor_error= (rx_message)->Data[7] ; //motor error mode
}

```

5.2.2 Servo Mode Serial Message Protocol

Servo mode serial port sending and receiving message protocol is as follows:

Frame header (0x02)	Data length	Data Frame	Data bit	Check the high 8 bits	Check the lower 8 bits	End of frame (0x03)
------------------------	-------------	------------	----------	-----------------------	------------------------	------------------------

Check digit calculation code refer to page 32
 data frame definition

```

typedef enum {
    COMM_FW_VERSION = 0,
    COMM_JUMP_TO_BOOTLOADER,
    COMM_ERASE_NEW_APP,
    COMM_WRITE_NEW_APP_DATA,
    COMM_GET_VALUES, //Get motor running parameters
    COMM_SET_DUTY, //Motor runs in duty cycle mode
    COMM_SET_CURRENT, //Motor runs in current loop mode
    COMM_SET_CURRENT_BRAKE, //Motor current brake mode operation
    COMM_SET_RPM, //Motor runs in current loop mode
    COMM_SET_POS, //Motor runs in position loop mode
    COMM_SET_HANDBRAKE, //Motor runs in handbrake current loop mode
    COMM_SET_DETECT, //Motor real-time feedback current position command
    COMM_ROTOR_POSITION=22, //Motor feedback current position
    COMM_GET_VALUES_SETUP=50, //Motor single or multiple parameter acquisition
instructions
    COMM_SET_POS_SPD=91, // Motor runs in position velocity loop mode
    COMM_SET_POS_MULTI=92, // Set the motor movement to single-turn mode
    COMM_SET_POS_SINGLE=93, // Set the motor motion to multi-turn mode, the range is
    ±100 turns
    COMM_SET_POS_UNLIMITED=94, //Save
    COMM_SET_POS_ORIGIN=95, //Set the motor origin
} COMM_PACKET_ID;

```

1. Obtain an example of motor parameters

Serial port command: 02 01 04 40 84 03 // Get the motor parameter command After the motor

receives the motor feedback once the motor status

Example of motor return serial port command: 02 49 04 01 66 FC D0 00 00 00 00 00 00 00 00 00
00 00 00 00 00 00 00 00 00 FF FF FF F3 00 F6 00 00 00 00 00 00 00 00 00 00 00 00 00 00 FF
FF FF FF 00 16 D7 AD 00 0A 6F 19 40 7E 00 00 00 00 00 00 00 00 00 00 00 04 4D 53 03 02
05 16 00 1A B6 03 C9 B5 03

// 02 (frame header) +49 (Data length) + 04 (Data Frame) + mos temperature (2byte) +motor
temperature (2byte) +output current (4byte) +input current (4byte) +Id current (4byte)
+Iq current(4byte)+Motor throttle value (2byte)+motor speed (4byte)+input voltage (2byte)
+reserved value (24byte)+Motor status code (1byte)+Motor outer ring position value (4byte)
+Motor Control ID Number (1byte) +Temperature retention value (6byte) +Vd voltage value
(4byte) +Vq voltage value (4byte) +CRC+03(end of frame)

The conversion formula of some parameters sent by the motor is as follows:

MOS temperature=(float)buffer_get_int16(data, &ind) / 10.0)
Motor temperature=(float)buffer_get_int16(data, &ind) / 10.0)
Output current=(float)buffer_get_int32(data, &ind) / 100.0)
Input current=(float)buffer_get_int32(data, &ind) / 100.0)
Id current=(float)buffer_get_int32(data, &ind) / 100.0)
Iq current=(float)buffer_get_int32(data, &ind) / 100.0)
Motor throttle value=(float)buffer_get_int16(data, &ind) / 1000.0)
Motor speed=(float)buffer_get_int32(data, &ind))
Input voltage=(float)buffer_get_int16(data, &ind) / 10.0)
Motor outer ring position=(float)buffer_get_int32(data, &ind) / 1000000.0)
Motor ID number=data
Motor Vd voltage=(float)buffer_get_int32(data, &ind) / 1000.0)
Motor Vq voltage=(float)buffer_get_int32(data, &ind) / 1000.0)

Motor feedback position message command

Serial command: 02 02 0B 04 9C 7E 03 // The motor sends the current position every 10ms
after receiving

Example of sending the motor feedback position value (the feedback position message command
needs to be sent to the motor in advance, and the current position is sent every 10ms after the
motor receives it)

Serial command: 02 05 16 00 1A B6 64 D5 F4 03
Pos=(float)buffer_get_int32(data, &ind) / 1000.0

Single or multiple parameter acquisition instruction instance of motor

Serial command: 02 05 32 00 00 00 01 58 4C 03 // Get motor temperature command

Instruction description: This instruction can acquire single or multiple motor parameters. The

acquired parameters are determined by the 4 bytes of the data segment. When the corresponding bit is 1, the motor will return the motor parameters of the corresponding bit. When it is 0, this field will be removed.

The motor parameters corresponding to the bits are as follows:

32-19 位	18 位	17 位	16 位	15-9 位	8 位	7 位	6 位
reserved value	Motor ID (1byte)	Motor error sign (1byte)	Motor position (4byte)	reserved value	Motor voltage (2byte)	reserve d value	Motor speed (4byte)
5 位	4 位	3 位	2 位	1 位			
motor throttle (2byte)	Input current (4byte)	Output current (4byte)	Motor temperature (2byte)	MO temperature (2byte)			

After the motor receives the command, it will send out the corresponding parameters

Example: 02 03 32 00 81 2A 6C 03 // Feedback motor temperature

The conversion formula of some parameters sent by the motor is as follows:

MOS Temperature=(float)buffer_get_int16(data, &ind) / 10.0)

Motor temperature=(float)buffer_get_int16(data, &ind) / 10.0)

Output current=(float)buffer_get_int32(data, &ind) / 100.0)

Input current=(float)buffer_get_int32(data, &ind) / 100.0)

Motor throttle value=(float)buffer_get_int16(data, &ind) / 1000.0)

Motor speed=(float)buffer_get_int32(data, &ind))

Input voltage=(float)buffer_get_int16(data, &ind) / 10.0)

Motor position=(float)buffer_get_int32(data, &ind) / 1000000.0)

Motor ID NUMBER=data

Motor error status code

typedef enum {

 FAULT_CODE_NONE = 0,

 FAULT_CODE_OVER_VOLTAGE,// OVER VOLTAGE

 FAULT_CODE_UNDER_VOLTAGE,// UNDER_VOLTAGE

 FAULT_CODE_DRV,// DRIVE FAULT

 FAULT_CODE_ABS_OVER_CURRENT,// OVER_CURRENT

 FAULT_CODE_OVER_TEMP_FET,// MOS OVER TEMPERATURE

 FAULT_CODE_OVER_TEMP_MOTOR,//MOS OVER TEMPERATURE

 FAULT_CODE_GATE_DRIVER_OVER_VOLTAGE,//DRIVER_OVER_VOLTAGE

 FAULT_CODE_GATE_DRIVER_UNDER_VOLTAGE,// DRIVER UNDER VOLTAGE

 FAULT_CODE_MCU_UNDER_VOLTAGE,// MCU UNDRE VOLTAGE

 FAULT_CODE_BOOTING_FROM_WATCHDOG_RESET,//UNDREVOLTAGE

```

FAULT_CODE_ENCODER_SPI,// SPI ENCODER FAULT
FAULT_CODE_ENCODER_SINCOS_BELOW_MIN_AMPLITUDE,//Encoder overrun
FAULT_CODE_ENCODER_SINCOS_ABOVE_MAX_AMPLITUDE,//Encoder overrun
FAULT_CODE_FLASH_CORRUPTION,// FLASH FAULT
FAULT_CODE_HIGH_OFFSET_CURRENT_SENSOR_1,// Current sampling channel 1 fault
FAULT_CODE_HIGH_OFFSET_CURRENT_SENSOR_2,// Current sampling channel 2 fault
FAULT_CODE_HIGH_OFFSET_CURRENT_SENSOR_3,// Current sampling channel 1 fault
FAULT_CODE_UNBALANCED_CURRENTS,// current unbalance

```

```
} mc_fault_code;
```

2. Examples of control commands:

Example of Duty Cycle Transmit Mode

```

Serial command: 02 05 05 00 00 4E 20 29 F6 03 // 0.20 duty cycle
Serial command: 02 05 05 FF FF B1 E0 77 85 03 // -0.20 duty cycle
Duty=(float)buffer_get_int32(data, &ind) / 100000.0 //值为 接收 4 位数据/10000.0

```

Example of current loop transmit mode

```

Serial command: 02 05 06 00 00 13 88 8B 25 03 // 5 A IQ 电流
Serial command: 02 05 06 FF FF EC 78 E3 05 03 // - 5 A IQ 电流
Current=(float)buffer_get_int32(data, &ind) / 1000.0 //值为接收 4 位数据/1000.0

```

Example of brake current sending mode

```

Serial command: 02 05 07 00 00 13 88 21 74 03 // 5A Braking current
Serial command: 02 05 07 FF FF EC 78 49 54 03 // - 5A Braking current
I_Brake=(float)buffer_get_int32(data, &ind) / 1000.0 //值为接收 4 位数据/1000.0

```

Example of speed loop sending mode

```

Serial command: 02 05 08 00 00 03 E8 2B 58 03 // 1000 ERPM Electrical speed
Serial command: 02 05 08 FF FF FC 18 43 78 03 // - 1000 ERPM Electrical speed
Speed=(float)buffer_get_int32(data, &ind) //值为接收 4 位数据

```

Example of position loop sending mode

```

Serial command: 02 05 09 0A BA 95 00 1E E7 03 //Motor turns to 180 degrees
Serial command: 02 05 09 05 5D 4A 80 7B 29 03 //Motor turns to 90 degrees
Pos=(float)buffer_get_int32(data, &ind) / 1000000.0 //值为接收 4 位数据/1000000.0

```

Handbrake current sending mode example

```

Serial command: 02 05 0A 00 00 13 88 00 0E 03 //5A HB current Electrical speed
Serial command: 02 05 0A FF FF EC 78 68 2E 03 //5A HB current Electrical speed
HAND_Brake=(float)buffer_get_int32(data, &ind) / 1000.0 //值为接收 4 位数据/1000.0

```

Handbrake current sending mode example

```
Serial command: 02 05 0A 00 00 13 88 00 0E 03 //5A HB current Electrical speed
Serial command: 02 05 0A FF FF EC 78 68 2E 03 //5A HB current Electrical speed
HAND_Brake=(float)buffer_get_int32(data, &ind) / 1000.0 //值为接收 4 位数据/1000.0
```

Example of Sending Mode of Position Velocity Loop

```
Serial command: 02 0D 5B 00 02 BF 20 00 00 13 88 00 00 75 30 A5 AC 03
/*
180 度 转速 5000ERPM 加速度 30000/S
数据段为 位置+ 速度 + 加速度
*/
Pos=(float)buffer_get_int32(data, &ind) / 1000.0 // 位置值为接收 4 位数据/1000.0
Speed=(float)buffer_get_int32(data, &ind) //值为接收 4 位数据
Acc_Speed=(float)buffer_get_int32(data, &ind)//值为接收 4 位数据
```

Example of setting multi-turn mode sending

```
Serial command: 02 05 5C 00 00 00 00 9E 19 03 //Set the motor position loop as multi-turn
operation mode ±100 turns
```

Setting the lap mode to send an example

```
Serial command: 02 05 5D 00 00 00 00 34 48 03 //Set the motor position loop to single-turn
operation mode 0-360 degrees
```

Set the current position to 0 to send the instance

```
Serial command: 02 02 5F 01 0E A0 03 //Set the current position loop of the motor as the zero
reference point of the position loop
```

Serial check:

```
unsigned short crc16(unsigned char *buf, unsigned int len) {
    unsigned int i;
    unsigned short cksum = 0;
    for (i = 0; i < len; i++) {
        cksum = crc16_tab[(((cksum >> 8) ^ *buf++) & 0xFF)] ^ (
cksum << 8);
    }
    return cksum;
}
const unsigned short crc16_tab[] = { 0x0000, 0x1021, 0x2042,
0x3063, 0x4084,
```

0x50a5, 0x60c6, 0x70e7, 0x8108, 0x9129, 0xa14a, 0xb16b, 0xc18c,
0xd1ad,
0xe1ce, 0xf1ef, 0x1231, 0x0210, 0x3273, 0x2252, 0x52b5, 0x4294,
0x72f7,
0x62d6, 0x9339, 0x8318, 0xb37b, 0xa35a, 0xd3bd, 0xc39c, 0xf3ff,
0xe3de,
0x2462, 0x3443, 0x0420, 0x1401, 0x64e6, 0x74c7, 0x44a4, 0x5485,
0xa56a,
0xb54b, 0x8528, 0x9509, 0xe5ee, 0xf5cf, 0xc5ac, 0xd58d, 0x3653,
0x2672,
0x1611, 0x0630, 0x76d7, 0x66f6, 0x5695, 0x46b4, 0xb75b, 0xa77a,
0x9719,
0x8738, 0xf7df, 0xe7fe, 0xd79d, 0xc7bc, 0x48c4, 0x58e5, 0x6886,
0x78a7,
0x0840, 0x1861, 0x2802, 0x3823, 0xc9cc, 0xd9ed, 0xe98e, 0xf9af,
0x8948,
0x9969, 0xa90a, 0xb92b, 0x5af5, 0x4ad4, 0x7ab7, 0x6a96, 0x1a71,
0x0a50,
0x3a33, 0x2a12, 0xdbfd, 0xcbdc, 0xfbbf, 0xeb9e, 0x9b79, 0x8b58,
0xbb3b,
0xab1a, 0x6ca6, 0x7c87, 0x4ce4, 0x5cc5, 0x2c22, 0x3c03, 0x0c60,
0x1c41,
0xedaе, 0xfd8f, 0xcdec, 0xddcd, 0xad2a, 0xbd0b, 0x8d68, 0x9d49,
0x7e97,
0x6eb6, 0x5ed5, 0x4ef4, 0x3e13, 0x2e32, 0x1e51, 0x0e70, 0xff9f,
0xefbe,
0xdfdd, 0xcffc, 0xbf1b, 0xaf3a, 0x9f59, 0x8f78, 0x9188, 0x81a9,
0xb1ca,
0xaleb, 0xd10c, 0xc12d, 0xf14e, 0xe16f, 0x1080, 0x00a1, 0x30c2,
0x20e3,
0x5004, 0x4025, 0x7046, 0x6067, 0x83b9, 0x9398, 0xa3fb, 0xb3da,
0xc33d,
0xd31c, 0xe37f, 0xf35e, 0x02b1, 0x1290, 0x22f3, 0x32d2, 0x4235,
0x5214,
0x6277, 0x7256, 0xb5ea, 0xa5cb, 0x95a8, 0x8589, 0xf56e, 0xe54f,
0xd52c,
0xc50d, 0x34e2, 0x24c3, 0x14a0, 0x0481, 0x7466, 0x6447, 0x5424,
0x4405,
0xa7db, 0xb7fa, 0x8799, 0x97b8, 0xe75f, 0xf77e, 0xc71d, 0xd73c,
0x26d3,
0x36f2, 0x0691, 0x16b0, 0x6657, 0x7676, 0x4615, 0x5634, 0xd94c,
0xc96d,

```
0xf90e, 0xe92f, 0x99c8, 0x89e9, 0xb98a, 0xa9ab, 0x5844, 0x4865,  
0x7806,  
0x6827, 0x18c0, 0x08e1, 0x3882, 0x28a3, 0xcb7d, 0xdb5c, 0xeb3f,  
0xfb1e,  
0x8bf9, 0x9bd8, 0xabbb, 0xbb9a, 0x4a75, 0x5a54, 0x6a37, 0x7a16,  
0x0af1,  
0x1ad0, 0x2ab3, 0x3a92, 0xfd2e, 0xed0f, 0xdd6c, 0xcd4d, 0xbdaa,  
0xad8b,  
0x9de8, 0x8dc9, 0x7c26, 0x6c07, 0x5c64, 0x4c45, 0x3ca2, 0x2c83,  
0x1ce0,  
0x0cc1, 0xef1f, 0xff3e, 0xcf5d, 0xdf7c, 0xaf9b, 0xbfba, 0x8fd9,  
0x9ff8,  
0x6e17, 0x7e36, 0x4e55, 0x5e74, 0x2e93, 0x3eb2, 0x0ed1, 0x1ef0  
};
```

```
//int16 数据位整理
```

```
void buffer_append_int16(uint8_t* buffer, int16_t number, int32_t *index) {  
    buffer[(*index)++] = number >> 8;  
    buffer[(*index)++] = number;  
}
```

```
//uint16 数据位整理
```

```
void buffer_append_uint16(uint8_t* buffer, uint16_t number, int32_t *index) {  
    buffer[(*index)++] = number >> 8;  
    buffer[(*index)++] = number;  
}
```

```
//int32 数据位整理
```

```
void buffer_append_int32(uint8_t* buffer, int32_t number, int32_t *index) {  
    buffer[(*index)++] = number >> 24;  
    buffer[(*index)++] = number >> 16;  
    buffer[(*index)++] = number >> 8;  
    buffer[(*index)++] = number;  
}
```

```
//uint32 数据位整理
```

```
void buffer_append_uint32(uint8_t* buffer, uint32_t number, int32_t *index) {  
    buffer[(*index)++] = number >> 24;  
    buffer[(*index)++] = number >> 16;  
    buffer[(*index)++] = number >> 8;  
    buffer[(*index)++] = number;  
}
```

//int64 数据位整理

```
void buffer_append_int64(uint8_t* buffer, int64_t number, int32_t *index) {
    buffer[*index++] = number >> 56;
    buffer[*index++] = number >> 48;
    buffer[*index++] = number >> 40;
    buffer[*index++] = number >> 32;
    buffer[*index++] = number >> 24;
    buffer[*index++] = number >> 16;
    buffer[*index++] = number >> 8;
    buffer[*index++] = number;
}
```

//uint64 数据位整理

```
void buffer_append_uint64(uint8_t* buffer, uint64_t number, int32_t *index) {
    buffer[*index++] = number >> 56;
    buffer[*index++] = number >> 48;
    buffer[*index++] = number >> 40;
    buffer[*index++] = number >> 32;
    buffer[*index++] = number >> 24;
    buffer[*index++] = number >> 16;
    buffer[*index++] = number >> 8;
    buffer[*index++] = number;
}
```

//CRC 校验

```
unsigned short crc16(unsigned char *buf, unsigned int len) {
    unsigned int i;
    unsigned short cksum = 0;
    for (i = 0; i < len; i++) {
        cksum = crc16_tab[(((cksum >> 8) ^ *buf++) & 0xFF)] ^ (cksum << 8);
    }
    return cksum;
}
```

//数据包的整理发送

```
void packet_send_packet(unsigned char *data, unsigned int len, int handler_num) {
    int b_ind = 0;
    unsigned short crc;
    if (len > PACKET_MAX_PL_LEN) {
        return;
    }
    if (len <= 256) {
```

```

        handler_states[handler_num].tx_buffer[b_ind++] = 2;
        handler_states[handler_num].tx_buffer[b_ind++] = len;
    } else {
        handler_states[handler_num].tx_buffer[b_ind++] = 3;
        handler_states[handler_num].tx_buffer[b_ind++] = len >> 8;
        handler_states[handler_num].tx_buffer[b_ind++] = len & 0xFF;
    }

    memcpy(handler_states[handler_num].tx_buffer + b_ind, data, len);
    b_ind += len;

    crc = crc16(data, len);
    handler_states[handler_num].tx_buffer[b_ind++] = (uint8_t)(crc >> 8);
    handler_states[handler_num].tx_buffer[b_ind++] = (uint8_t)(crc & 0xFF);
    handler_states[handler_num].tx_buffer[b_ind++] = 3;

    if (handler_states[handler_num].send_func) {
        handler_states[handler_num].send_func(handler_states[handler_num].tx_buffer,
        b_ind);
    }
}

```

5.3 MIT power mode communication protocol

Special Can code

Enter motor control mode {0xFF, 0xFF, 0xFF, 0xFF, 0xFF, 0xFF, 0xFF, 0xFC }

Exit motor control mode {0xFF, 0xFF, 0xFF, 0xFF, 0xFF, 0xFF, 0xFF, 0xFD }

Set the current position of the motor to 0 {0xFF, 0xFF, 0xFF, 0xFF, 0xFF, 0xFF, 0xFF, 0xFE }

Note: motor control mode must be entered before using CAN communication control motor!

If you want to read the current state when there is no state, the command sent is:

{0xFF, 0xFF, 0xFF, 0xFF, 0xFF, 0xFF, 0xFF, 0xFC }

Force control mode drive board receives data definition

Identifier: set motor ID (default: 1)
frame

Frame type: standard

Frame format: DATA

DLC: 8 bytes

Data fields	DATA[0]	DATA[1]	DATA[2]	DATA[3]	
Data bits	7-0	7-0	7-0	7-4	3-0
The data content	Motor position 8 bit high	Motor position 8 bit low	Motor speed 8 bit high	Motor speed 4 bit low	KP value 4 bit high

Data fields	DATA[4]	DATA[5]	DATA[6]		DATA[7]
Data bits	7-0	7-0	7-4	3-0	0-7
The data content	KP value 8 bit low	KD value 8 bit high	KD value 4 bit low	Current value 4 bit high	Current value 8 bit low

MIT power mode driver board sending data definition

Identifier: 0X00+ Drive ID

Frame type: standard frame

Frame format: DATA

DLC: 6 bytes

Data fields	DATA[0]	DATA[1]	DATA[2]	DATA[3]	DATA[4]
Data bits	7-0	7-0	7-0	7-0	7-4
The data content	Driver board ID code	Motor position 8 bit higher	Motor position 8 bit lower	Motor speed 8 bit higher	Motor speed 4 bit lower

Data fields	DATA[4]	DATA[5]	DATA[6]	DATA[7]
Data bits	3-0	7-0	7-0	7-0
The data content	Current 4 bit higher	Current 8 bit lower	Motor temperature	An error code

CAN Speed: 1 MHZ

Simple block diagram of MIT power mode

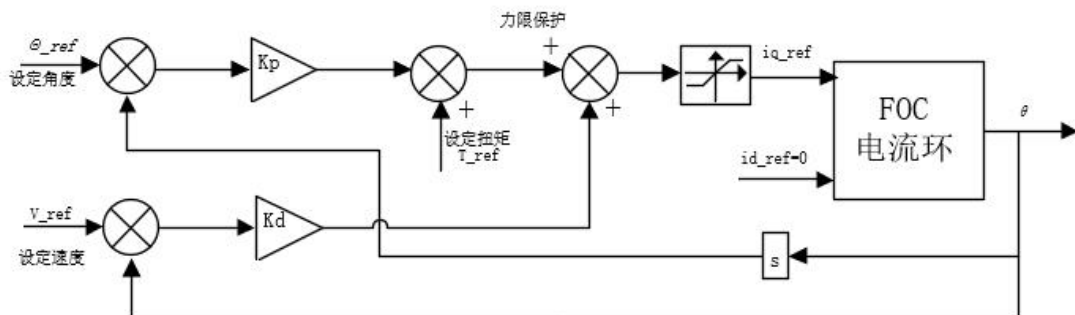

Operation control mode send and receive code routines

Module	AK10-9	AK60-6	AK70-10	AK80-6	AK80-9	AK80-80
--------	--------	--------	---------	--------	--------	---------

Position (rad)	-12.5f-12.5f					
Speed (rad/s)	-50.0f-50.0f	-45.0f-45.0f	-50.0f-50.0f	-76.0f-76.0f	-50.0f-50.0f	-8.0f-8.0f
Torque (N.M)	-65.0f-65.0f	-15.0f-15.0f	-25.0f-25.0f	-12.0f-12.0f	-18.0f-18.0f	-144.0f-144.0f
Kp range	0-500					
Kd range	0-5					

Sends routine code

```

void pack_cmd(CANMessage * msg, float p_des, float v_des, float kp, float kd, float t_ff){
  /// limit data to be within bounds ///
  float P_MIN =-95.5;
  float P_MAX =95.5;
  float V_MIN =-30;
  float V_MAX =30;
  float T_MIN =-18;
  float T_MAX =18;
  float Kp_MIN =0;
  float Kp_MAX =500;
  float Kd_MIN =0;
  float Kd_MAX =5;
  float Test_Pos=0.0;
  p_des = fminf(fmaxf(P_MIN, p_des), P_MAX);
  v_des = fminf(fmaxf(V_MIN, v_des), V_MAX);
  kp = fminf(fmaxf(Kp_MIN, kp), Kp_MAX);
  kd = fminf(fmaxf(Kd_MIN, kd), Kd_MAX);
  t_ff = fminf(fmaxf(T_MIN, t_ff), T_MAX);
  /// convert floats to unsigned ints ///
  int p_int = float_to_uint(p_des, P_MIN, P_MAX, 16);
  int v_int = float_to_uint(v_des, V_MIN, V_MAX, 12);
  int kp_int = float_to_uint(kp, KP_MIN, KP_MAX, 12);
  int kd_int = float_to_uint(kd, KD_MIN, KD_MAX, 12);
  int t_int = float_to_uint(t_ff, T_MIN, T_MAX, 12);
  /// pack ints into the can buffer ///
  msg->data[0] = p_int>>8;          // Position 8 higher
  msg->data[1] = p_int&0xFF;       // Position 8 lower
  msg->data[2] = v_int>>4;         // Speed 8 higher
  msg->data[3] = ((v_int&0xF)<<4)|(kp_int>>8); //
  Speed 4 bit lower KP 4bit higher

```

```

msg->data[4] = kp_int&0xFF;          // KP 8 bit lower
msg->data[5] = kd_int>>4;           // Kd 8 bit higher
msg->data[6] = ((kd_int&0xF)<<4)|(kp_int>>8);    //
                                                KP 4 bit lower torque 4 bit higher

msg->data[7] = t_int&0xFF;          // torque 4 bit lower

}

```

When sending packets, all the numbers should be converted into integer numbers by the following functions and then sent to the motor.

```

int float_to_uint(float x, float x_min, float x_max, unsigned int bits)
{
/// Converts a float to an unsigned int, given range and number of bits ///
float span = x_max - x_min;
if(x < x_min) x = x_min;
else if(x > x_max) x = x_max;
return (int) ((x - x_min)*((float)((1<<bits)/span)));
}

```

Receive routine code

```

void unpack_reply(CANMessage msg){
/// unpack ints from can buffer ///
int id = msg.data[0]; //驱动 ID 号
int p_int = (msg.data[1]<<8)|msg.data[2];          //Motor position data
int v_int = (msg.data[3]<<4)|(msg.data[4]>>4);     // Motor speed data
int i_int = ((msg.data[4]&0xF)<<8)|msg.data[5];     // Motor torque data

/// convert ints to floats ///
float p = uint_to_float(p_int, P_MIN, P_MAX, 16);
float v = uint_to_float(v_int, V_MIN, V_MAX, 12);
float i = uint_to_float(i_int, -I_MAX, I_MAX, 12);
    if(id == 1){
postion = p;          //
                    // Read the corresponding data according to the ID code

speed = v;
torque = i;
    }
}

```

All numbers are converted to floating-point by the following function.

```

float uint_to_float(int x_int, float x_min, float x_max, int bits){

```

```
/// converts unsigned int to float, given range and number of bits ///  
float span = x_max - x_min;  
float offset = x_min;  
return ((float)x_int)*span/((float)((1<<bits)-1)) + offset;  
}
```