

时间 (DATE)	修正版本 (REV)	变更内容 (CHANGES)
/	V1.0	/
/	/	/

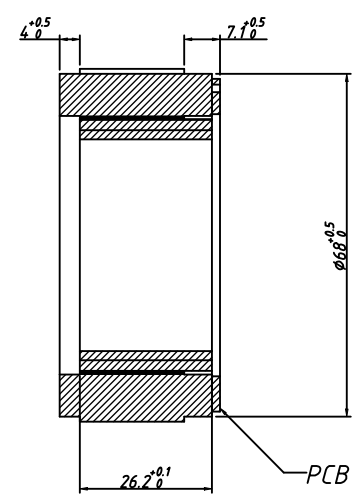

SECTION A-A

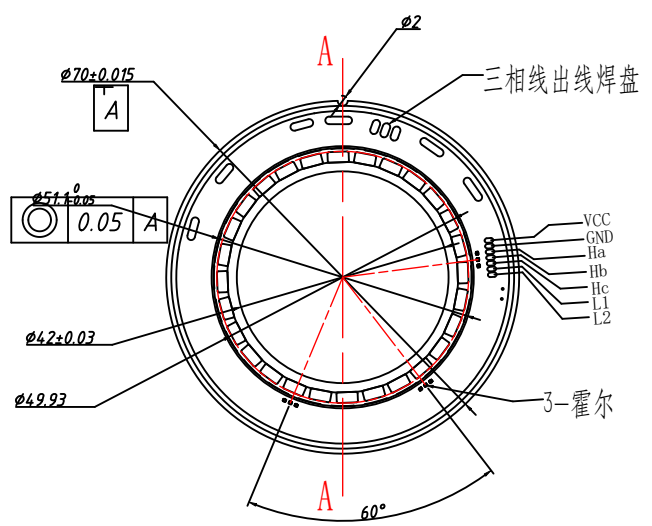
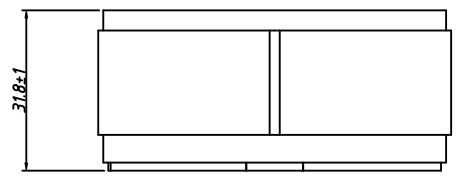

Wires for Hall AWG30						
VCC	GND	Ha	Hb	Hc	L1	L2
RED	BLK	BLU	GRN	YEL	/	/
热敏型号: MF51B103F3950						

保密说明: PROPRIETARY AND CONFIDENTIAL
 此份图纸包含的所有信息均只属于T-MOTOR财产。未经T-MOTOR书面许可, 禁止部分或全部复制。
 THE INFORMATION CONTAINED IN THIS DRAWING IS THE SOLE PROPERTY OF T-MOTOR. ANY REPRODUCTION IN PART OR AS A WHOLE WITHOUT THE WRITTEN PERMISSION OF T-MOTOR IS PROHIBITED.



	签名 (NAME)	日期 (DATE)	标题 (TITLE)	无框内转电机		
制图 (DRAWN)	***	***	型号 (DWG. NO)	RI75-PH		
审核 (CHECKED)	***	***	版本 (REV)	V1.0	单位 (UNIT)	mm
此图纸标注的尺寸有限, 个别尺寸公差据要求提供。 THIS IS A LIMITED DIMENSION DRAWING. SPECIFIC TOLERANCE AVAILABLE UPON REQUEST.			比例 (SCALE)	1:1	视角 (VIEW)	