



RC14668218

**OLAWUYI RACETT NIGERIA LTD.
WELLINGTON SQUARE, OXFORD
OX1 2JD, LONDON, UNITED KINGDOM**

RC14668218



EL ELYON

COMPANY EXECUTIVES

OLAWUYI RACETT NIGERIA LTD.

WELLINGTON SQUARE, OXFORD

OX1 2JD, LONDON, UNITED KINGDOM

RC14668218



RC14668218

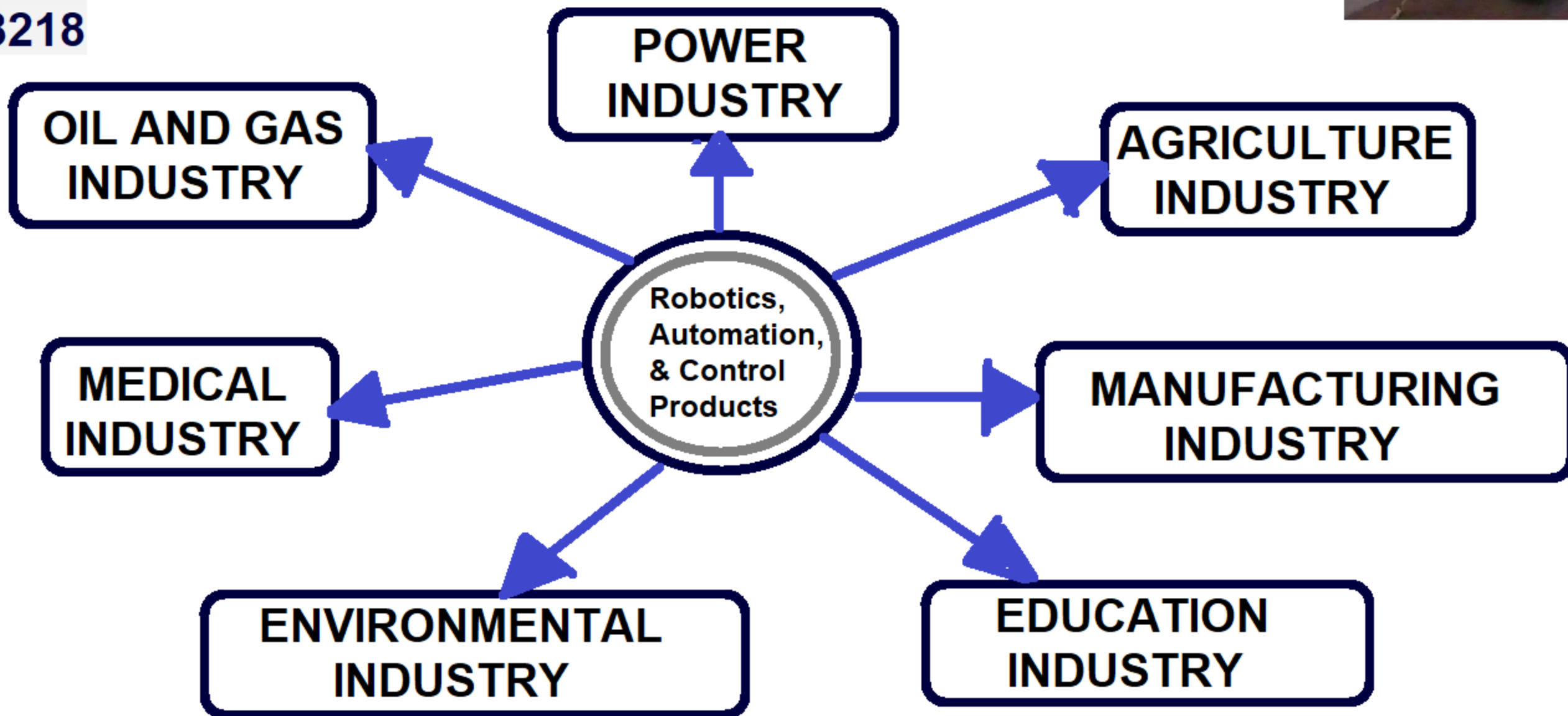

OLAWUYI RACETT NIGERIA LTD.

WELLINGTON SQUARE, OXFORD
OX1 2JD, LONDON, UNITED KINGDOM
RC14668218



RC14668218

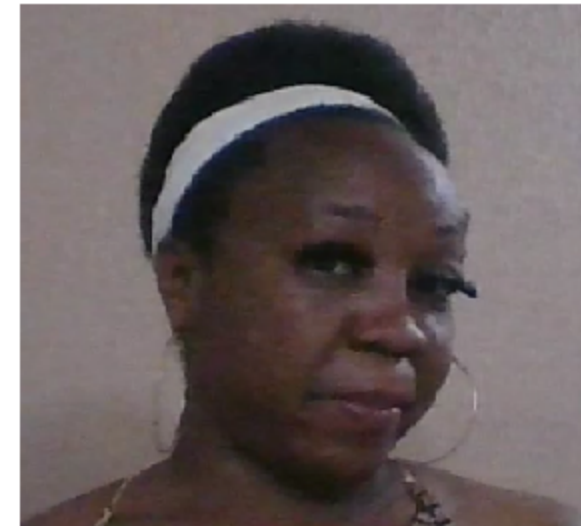

AUTOMATED CRUDE TRANSPORTER



GROSS

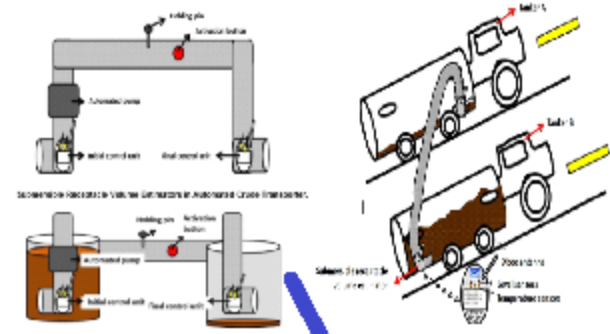

PEPVEAT

AUTOMATED CRUDE CONSTITUENT EXTRACTOR

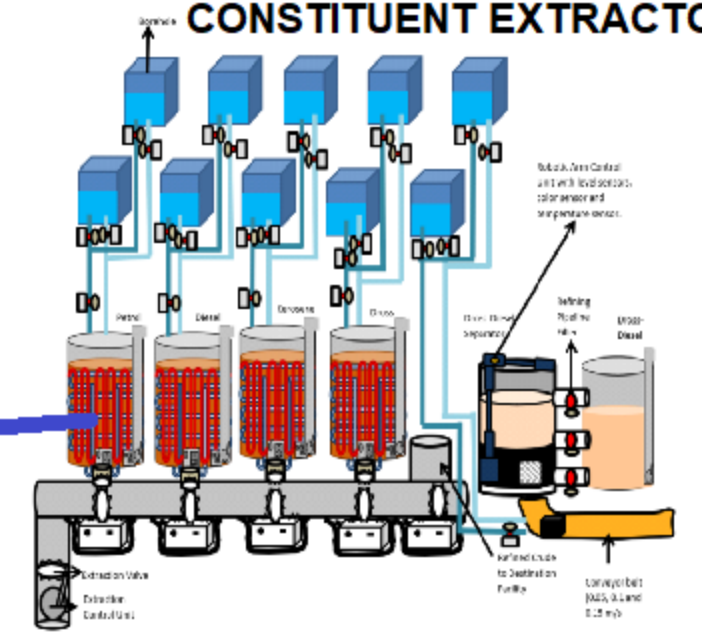

OIL & GAS

AUTOMATED REFINER

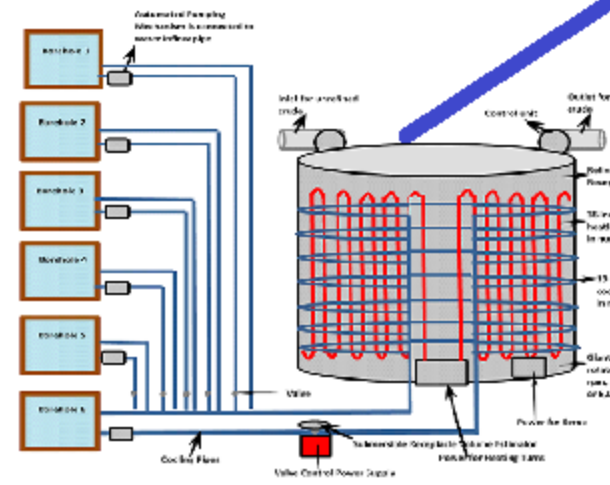

VANDALIZATION DETECTION

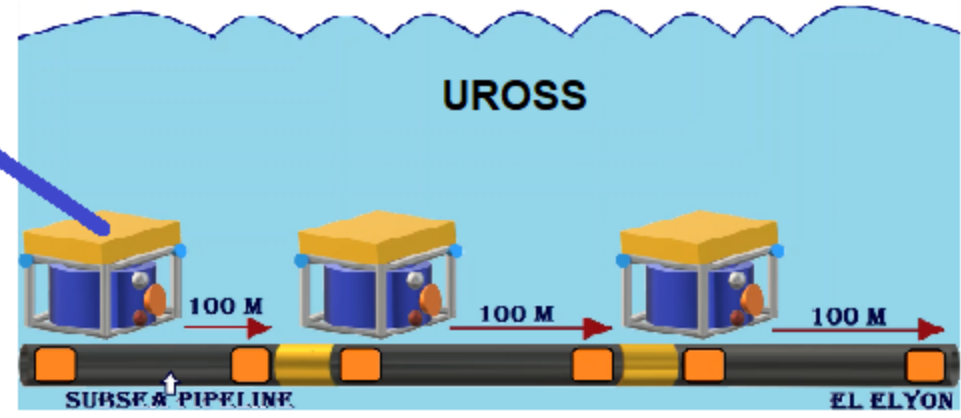

UROSS



AROSS



RC14668218

OLAWUYI RACETT NIGERIA LTD.

WELLINGTON SQUARE, OXFORD
OX1 2JD, LONDON, UNITED KINGDOM
RC14668218

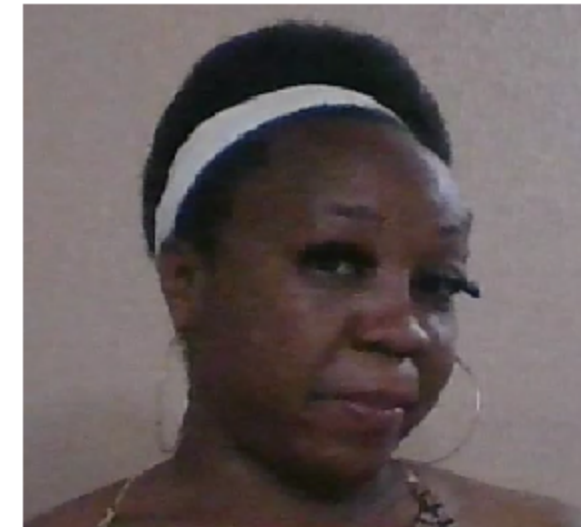

NATIONAL POWER OPTIMIZATION SOFTWARE

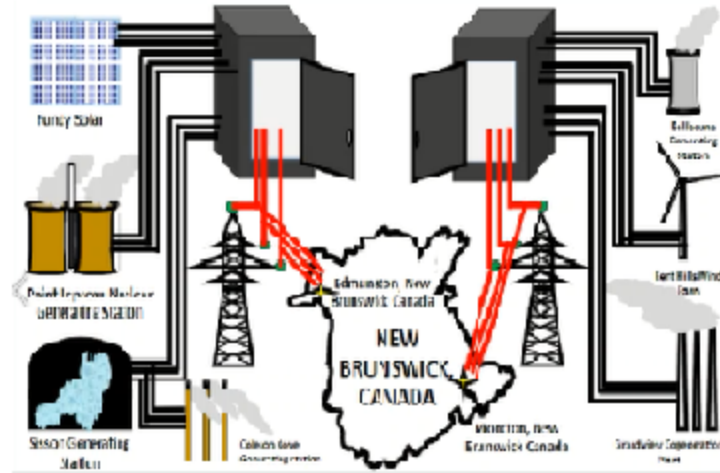

COUNTRY: CANADA

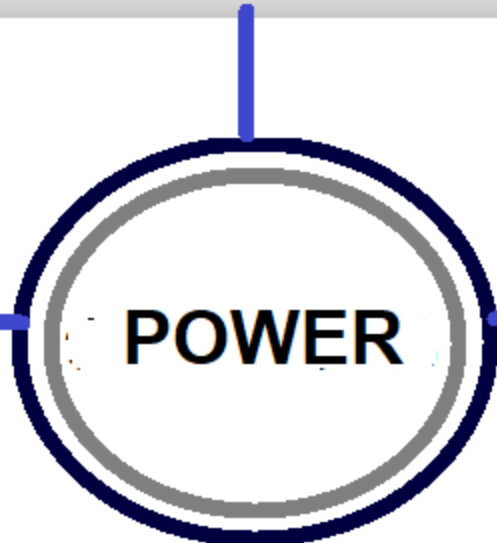

NATIONAL POWER OPTIMIZATION SOFTWARE

NATIONAL POWER OPTIMIZATION SOFTWARE FOR NIGERIA

OLAWUYI RACETT NIGERIA LTD., KEMP HOUSE, 180 CITY ROAD, EC1Y 2NX, LONDON, UNITED KINGDOM WITH RC14668218

EXISTING GENERATING STATIONS IN NIGERIA

AES	IEOM	RIVERS
AFAM HV	HOVBOR	SAPELE
AFAM VI	ODUKPANI	SAPELE II
ALAOJI	OKPAI	TRANS-AMADI
ASCO	OLORUNSOGB	DELTA
AZURA	OLORUNSCGO II	JEBBA
EGBAIN	OMOKU	KAINJI
GBARAIN	OMOTOSHO I	SHIRORO
GEREGU I	OMOTOSHO II	GEREGU I
	PARAS ENERGY	

POWER GENERATION
POWER TRANSMISSION
POWER DISTRIBUTION

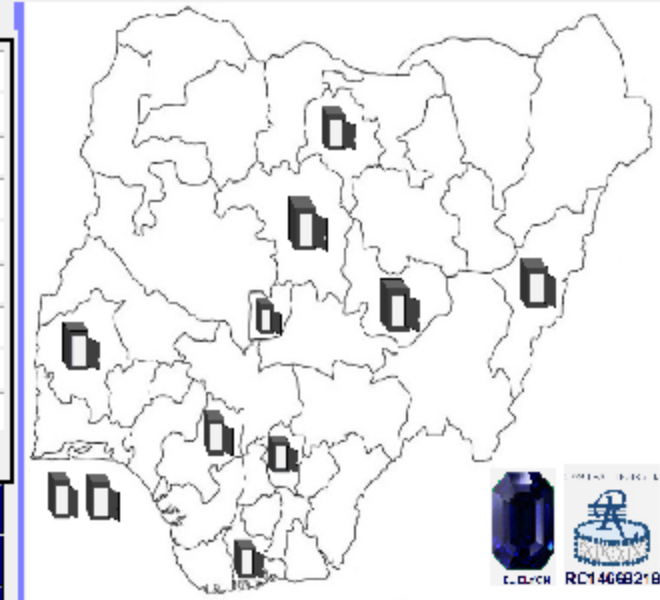

NATIONAL POWER OPTIMIZATION SOFTWARE

NEW PLANT PERFORMANCE

CROSS RIVER

TOTAL POWER PRODUCED IN NIGERIA ON Tuesday, October 24, 2023
21000 MW

TOTAL POWER RECEIVED BY PHDC: 4032.92 MW

CONNECTED TO: Bayelsa, Cross, Abia, Imo & Cross River

NO OF HOURS OF ELECTRICITY PER DAY

SITE	BEFORE CONNECTION	AFTER CONNECTION
BAYELSA RIVERS	4	2
OKPAI IEOM	4	2
CROSS RIVER	4	2

CONNECTED TO: Cross River

NO OF HOURS OF ELECTRICITY PER DAY

STATE	BEFORE CONNECTION	AFTER CONNECTION
CROSS RIVER	4	2

LEGEND
OL
GAS
NUCLEAR
HYDRO



RC14668218

OLAWUYI RACETT NIGERIA LTD.

WELLINGTON SQUARE, OXFORD
OX1 2JD, LONDON, UNITED KINGDOM
RC14668218

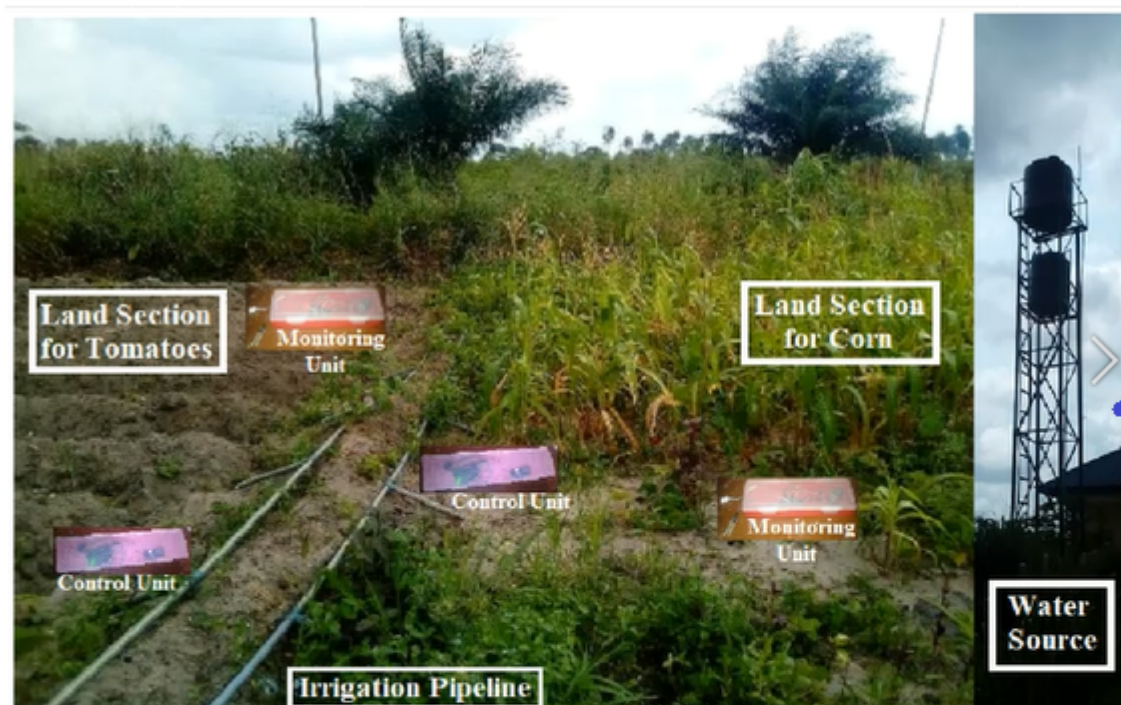
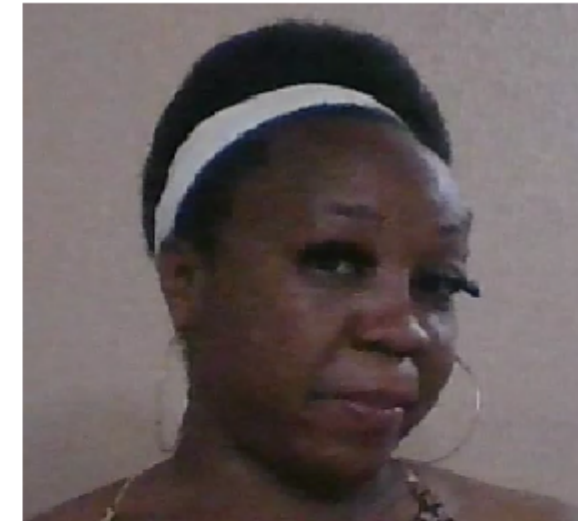

AUTOMATED IRRIGATION SYSTEM

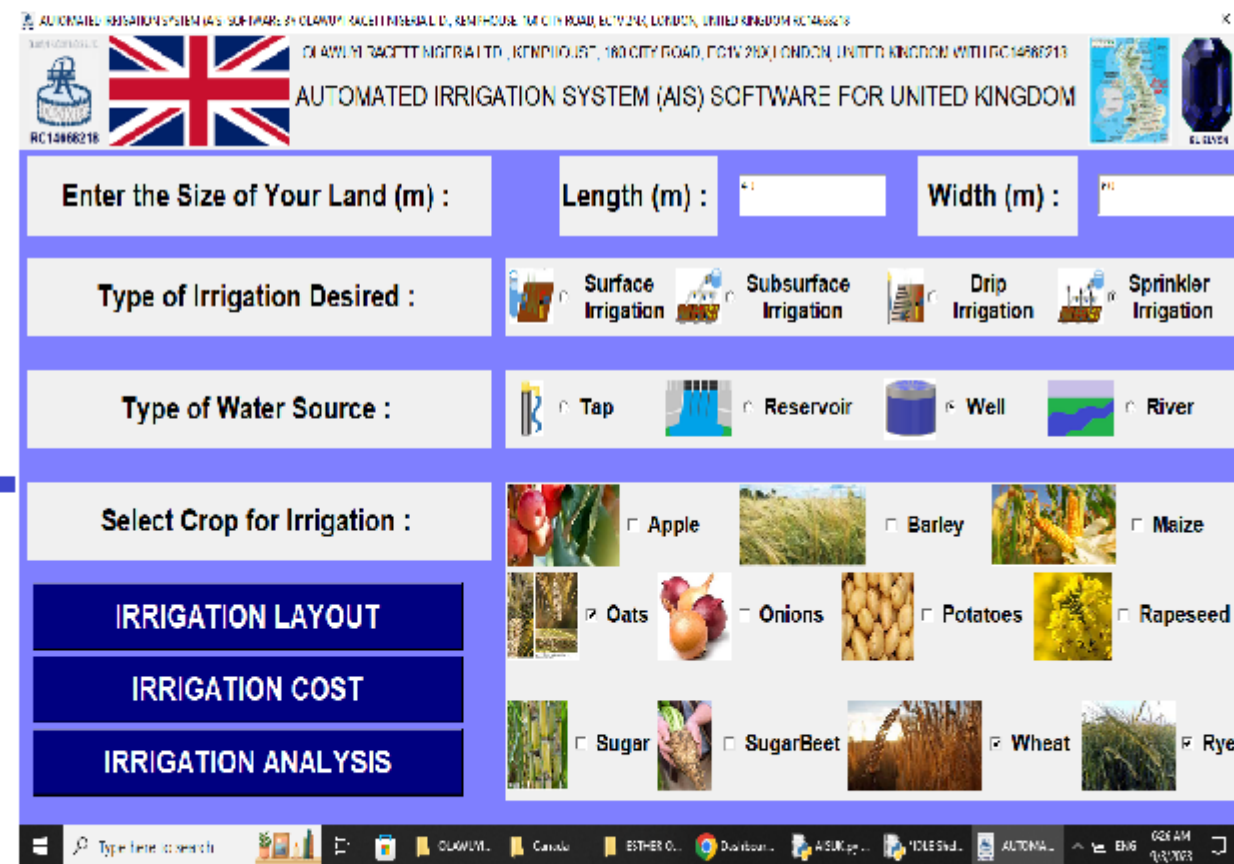

AUTOMATED IRRIGATION SYSTEM SOFTWARE



RC14668218

OLAWUYI RACETT NIGERIA LTD.

WELLINGTON SQUARE, OXFORD
OX1 2JD, LONDON, UNITED KINGDOM
RC14668218



MEDLINK



(a)



(b)



(c)



(d)



(e)



(f)

ELECTRONIC MEDICAL SOFTWARE

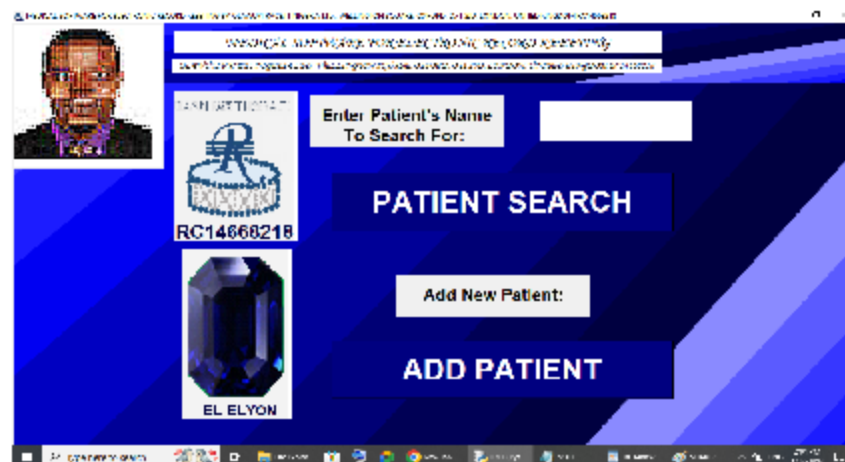

ClinicalTrials.gov PRS Protocol Registration and Results System

ClinicalTrials.gov Protocol Registration and Results System (PRS) Receipt
Receipt Date: January 20, 2024

ClinicalTrials.gov ID: [Not yet assigned]

Study Identification

Unique Protocol ID: N101

Full Title: Medlink for Diagnosing of Isolated Medians, (C0110) C011, Myasthenia Gravis and Hypertension

Short Title: Medlink for Diagnosing of Isolated Medians, (C0110) C011, Myasthenia Gravis and Hypertension

Secondary IDs:

Study Status

Receipt Verification: January 2024

Overall Status: Completed

Study Start: June 18, 2023 (Actual)

Primary Completion: December 15, 2024 (Actual)

Study Completion: December 15, 2024 (Actual)



RC14668218

OLAWUYI RACETT NIGERIA LTD.
WELLINGTON SQUARE, OXFORD
OX1 2JD, LONDON, UNITED KINGDOM
RC14668218



PRODUCT-BASED COURSES

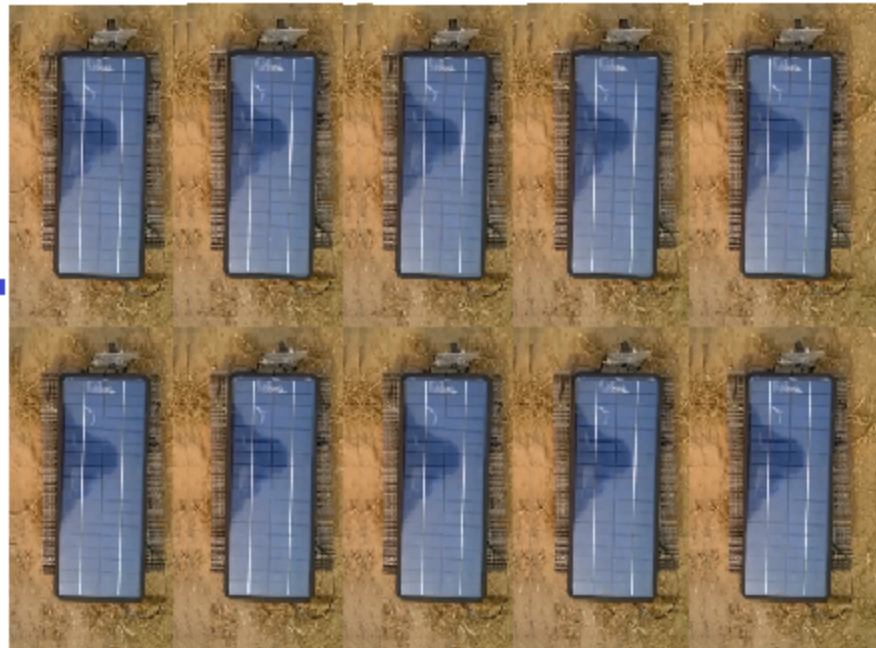

GRADING

- **Milestone 1 (20%)** - Was the student able to manufacture the company's product and demonstrate the operation of Tier 1 features of the product?
- **Milestone 2 (20%)** - Was the student able to manufacture the company's product and demonstrate the operation of Tier 2 features of the product?
- **Product Research and Publication (20%)** - The Student is assigned a research topic on the company's product and is expected to prepare a publication based on the results obtained.
- **Product Demonstration and Presentation (20%)** - The student will give a Final PowerPoint Presentation on their designed company product, and physically demonstrate the working of the product to the Professor.



RC14668218

OLAWUYI RACETT NIGERIA LTD.
WELLINGTON SQUARE, OXFORD
OX1 2JD, LONDON, UNITED KINGDOM
RC14668218

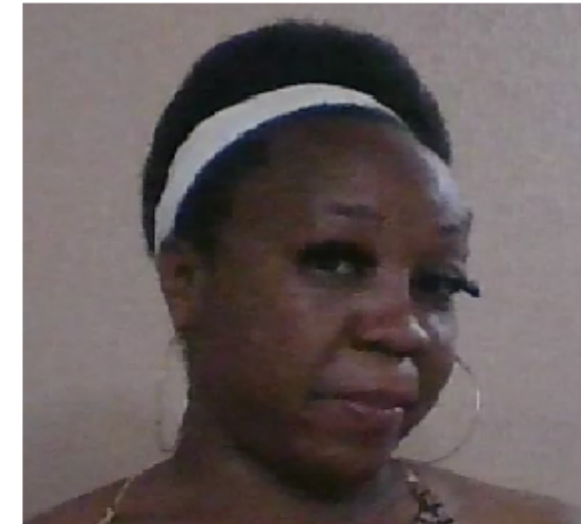

ENVIRONMENTAL DRONE



NATIONAL AIR QUALITY INDEX (AQI) SOFTWARE

AIR QUALITY INDEX (AQI) MAP FOR UNITED KINGDOM

OLAWUYI RACETT NIGERIA LTD. WELLINGTON SQUARE, OXFORD, OX1 2JD, LONDON, UNITED KINGDOM RC14668218

- ENGLAND
- IRELAND
- NORTHERN IRELAND
- SCOTLAND
- WALES

Windows taskbar: Type here to search, 10:07 AM, 2/13/2024

AIR QUALITY INDEX (AQI) MAP FOR UNITED KINGDOM

OLAWUYI RACETT NIGERIA LTD. WELLINGTON SQUARE, OXFORD, OX1 2JD, LONDON, UNITED KINGDOM RC14668218

February 13, 2024

AQI Value	AQI Category	Color Code
0 - 50	Good	BLUE
51 - 100	Moderate	SILVER
101 - 150	Unhealthy for Sensitive Groups	CREAM
151 - 200	Unhealthy	ORANGE
201 - 300	Very Unhealthy	RED
301 - 500	Hazardous	VIOLET
N/A	Not Available	GREEN

SO2



PARTNERS WITH TWELVE MAJOR GLOBAL OIL AND GAS COMPANIES IN OGCI (WWW.OGCI.COM)



- ARAMCO
- BP
- CHEVRON
- CNPC
- EQUINOR
- ENI
- REPSOL
- SHELL
- EXXONMOBIL
- REPSOL
- OCCIDENTAL
- PETROBRAS

OX1 2JD





INDEPENDENT OIL AND GAS COMPANY WITH THE SOCIETY OF PETROLEUM ENGINEERS(SPE) IN CANADA - #4541725



Society of Petroleum Engineers

Certificate of Appreciation

The Society of Petroleum Engineers would like to recognize

Esther Olawuyi

for volunteering as a Careers Advisor for the
SPE Virtual Career Pathways Fair
25-27 April 2023

James Whitaker
Senior Young Member Programs Manager
Society of Petroleum Engineers



ONGOING COLLABORATION WITH SHELL ONWARD

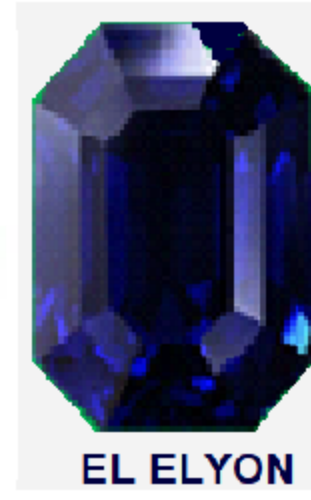

HTTPS://THINKONWARD.COM

The screenshot shows a web browser window displaying the Onward website. The browser's address bar shows the URL: https://thinkonward.com/the-platform/platform-overview/?utm_campaign=Rebrand%20Launch&utm_medium=email&_hsmi=285334788&_hsenc=p2AN.... The website's navigation menu includes: **onward** (logo), [About](#), [The Platform](#) (underlined), [Get Involved](#), [Resources](#), [Contact](#), [Register](#), and [Sign in](#). The main content area features a large image of a woman working on a laptop, with a large orange 'O' graphic overlaid. Below the image, the text reads: **A platform for change** and *A digital ecosystem that powers changemakers to work faster and smarter than ever before.* At the bottom of the browser window, a Windows taskbar is visible with the search bar and several application icons including EDRONE, VSDC Video Edit..., and SWILL4 - Paint. The system tray shows the time as 3:31 AM on 1/5/2024.

OLAWUYI RACETT NIGERIA LTD.



RC14668218

LIFE MEMBERS WITH THE INSTITUTE OF ELECTRICAL AND ELECTRONICS ENGINEERING (IEEE) - #99024938

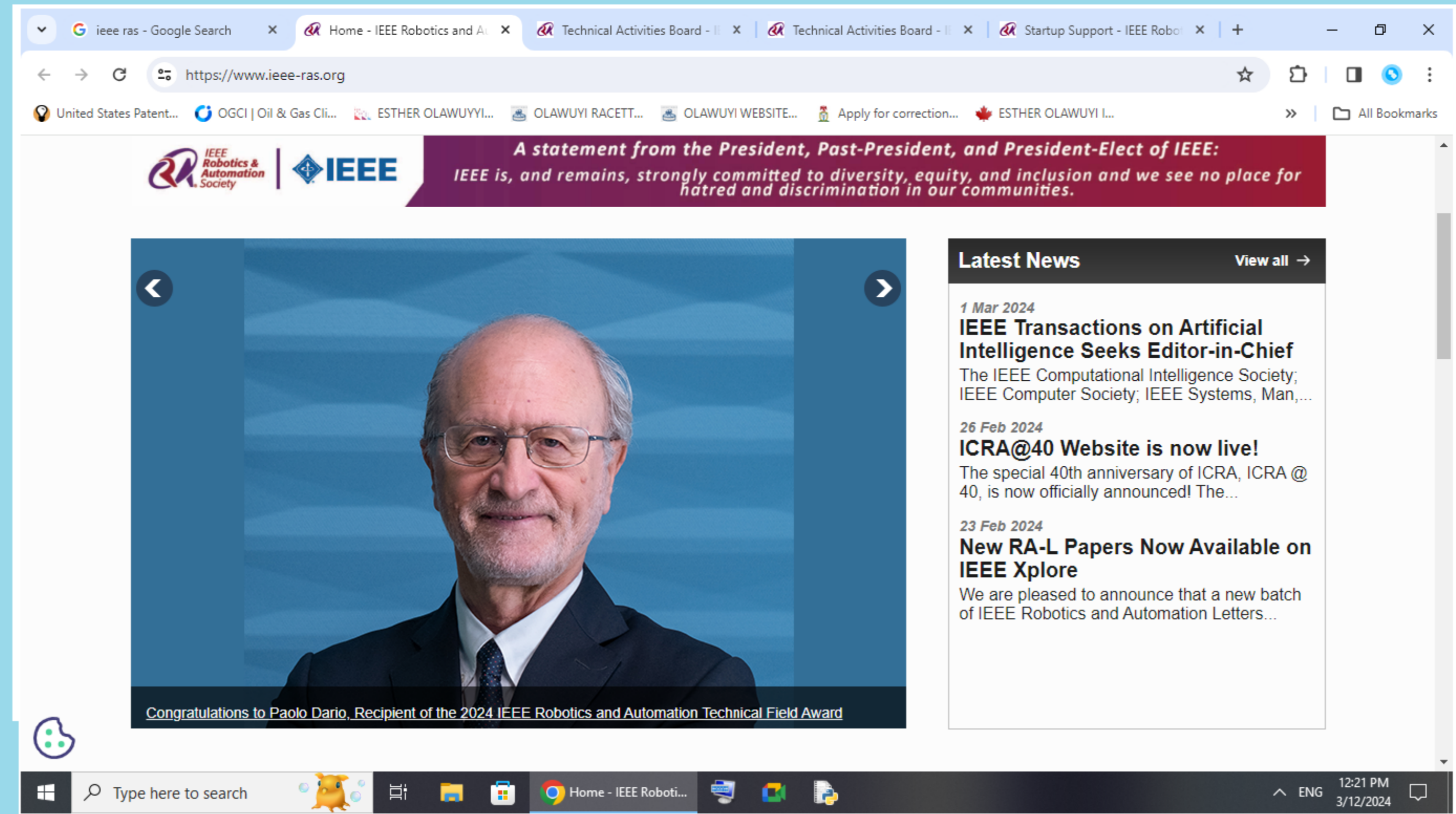



MEMBERS OF INDUSTRIAL ACTIVITIES BOARD (IAB) IN ROBTICS AND AUTOMATION SOCIETY, IEEE, USA



The screenshot shows the IEEE Robotics & Automation Society website. At the top, there is a banner for 'Industry & Government' with an image of industrial machinery. Below the banner is a navigation bar with links to IEEE.org, IEEE Xplore Digital Library, IEEE Standards, IEEE Spectrum, and More Sites. The main navigation menu includes About RAS, Membership, Conferences & Workshops, Publications, Technical Committees, Education, Outreach and Career, Awards & Recognition, and Industry & Government. The current page is 'Technical Activities Board'. The page content includes a search bar, a 'Resource Center' button, and a 'Join IEEE RAS' button. The main heading is 'Technical Activities Board'. The text describes the board's focus on research content and lists its members. The Vice President is identified as Kyujin Cho, with his contact information provided.

IEEE.org | IEEE Xplore Digital Library | IEEE Standards | IEEE Spectrum | More Sites

Join IEEE | Sign In

IEEE Robotics & Automation Society

Search IEEE RAS Search

Resource Center Robotics History Join IEEE RAS

About RAS Membership Conferences & Workshops Publications Technical Committees Education, Outreach and Career Awards & Recognition Industry & Government

Home > Technical Committees > Technical Activities Board

Technical Activities Board

Technical Committees

How to Join an IEEE RAS Technical Committee

Technical Committee Clusters

TAB NewsTechnical Activities Board The Technical Activities Board (TAB) focuses on the research content of the IEEE Robotics and Automation Society, tracking technical developments and encouraging innovation in: applications, theory, models, metrics, experiments, architectures, products, initiatives, and other technical areas. The TAB oversees the Technical Committees and the Distinguished Lecturer programs. The TAB is chaired by the Vice President for Technical Activities. Members of the TAB include all current Technical Committee Co-Chairs, and five members appointed by the RAS President. Vice President - Technical Activities **Kyujin Cho** Seoul National University Seoul, South Korea RAS Geographic Region 3 Email: ras.tab.vp@ieee.org



RC14668218

C.E.O.S



EL ELYON



ESTHER OLAWUYI



MICHAEL OLAWUYI



RC14668218

ACKNOWLEDGEMENTS



EL ELYON



COMPANY DIRECTORS

DR. MICHAEL FREEMAN
DR. MATTHEW OLAWUYI
ENG. FRANCIS OLAWUYI
ENG. JOSHUA OLAWUYI
DR. SUNDAY OLAWUYI
ENG. ENOCH EJOFODOMI
ENG. EFEJERA EJOFODOMI
DR. GODSWILL OFUALAGBA
DR. DIDI OMIYI

DR. DEEDEE FREEMAN
DR. JASON M. ZARA
DR. VESNA ZDERIC
DR. MOHAMED CHOUIKHA
ENG. TOJAKE EJOFODOMI
ENG. SYLVESTR EJOFODOMI
DR. C.J. KIM
DR. ANDERSON
ENG. ESOSA EHANIRE



RC14668218

ACKNOWLEDGEMENTS

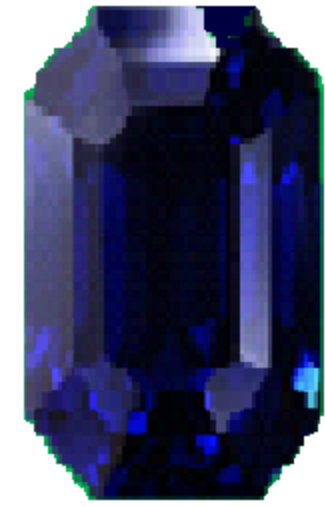

EL ELYON



INDUSTRIAL DIRECTORS

DR. MATTHEW OLAWUYI
ENG. JOSHUA OLAWUYI
DR. SUNDAY OLAWUYI
ENG. ENOCH EJOFODOMI
ENG. EFEJERA EJOFODOMI
MS. OCHAMUKE EJOFODOMI
DR. GODSWILL OFUALAGBA
ENG. MATTHEW AGHOLOR
MRS. LOVETTA AGHOLOR
DR. JASON M. ZARA

DR. MOHAMED CHOUIKHA
DR. LUCKY EJOFODOMI
ENG. TOJAKE EJOFODOMI
ENG. OMAFUME EJOFODOMI
ENG. SYLVESTR EJOFODOMI
MR. JACKSON UKWAIDE
ENG. ONOME OMIYI
ENG. DIDI OMIYI
MS. KOME ODU
DR. ANDERSON
ENG. ESOSA EHANIRE



RC14668218

ACKNOWLEDGEMENTS



EL ELYON



INVESTMENT OFFICERS

ENG. FRANCIS OLAWUYI
ENG. JOSEPH OLAWUYI
DR. SUNDAY OLAWUYI
DR. GODSWILL OFUALAGBA
ENG. MATTHEW AGHOLOR
MRS. LOVETTA AGHOLOR
DR. JASON M. ZARA
DR. MURRAY LOEW

DR. GARY HARRIS
ENG. OMAFUME EJOFODOMI
MS. RUKEME EJOFODOMI
MRS. JADESOLA EJOFODOMI
MR. JACKSON UKWAIDE
MR. AKIN EJOFODOMI
ENG. ONOME OMIYI
MS. AJAIRE ODU



RC14668218

ACKNOWLEDGEMENTS



EL ELYON



ACCOUNT OFFICERS

MS. RUKEME EJOFODOMI

MR. JACKSON UKWAIDE

MS. ISI OMIYI



RC14668218

ACKNOWLEDGEMENTS



EL ELYON



MARKETING EXECUTIVES

ENG. JOSEPH OLAWUYI



RC14668218

FINANCIAL ACCOUNTS



EL ELYON

**OLAWUYI RACETT NIGERIA LTD.,
WELLINGTON SQUARE, OXFORD,
OX1 2JD LONDON, UNITED KINGDOM
RC14668218 RECEIVES
ELECTRONIC PAYMENT FOR ALL
SERVICES USING WISE
([HTTPS://WISE.COM/LOGIN](https://wise.com/login)) BY
EMAIL ADDRESS
(TEGAE@GWMAIL.GWU.EDU) OR
OUR WISETAG SHOWN HERE:**



@ESTHER0611WISETAG