

# Bob PetHair Plus

OWNER'S MANUAL



# **Bob PetHair Plus**

## OWNER'S MANUAL

Model WPP56002, WPP56003, and WPP56004  
Manual Version 2021.1

# Congratulations!

Congratulations on your new intelligent floor cleaner! Bob is now at your service. To see Bob at his best, please read the Quick Start Guide and this manual thoroughly.

Welcome to the bObsweep family and Happy Sweeping!



If you have any questions or concerns, feel free to contact our helpful support team at [support@bobsweep.com](mailto:support@bobsweep.com) or 1-888-549-8847.

Our business hours are Monday – Friday, 9 a.m. – 5 p.m. Pacific Time.

# Important Safety Instructions

Flip Bob's power switch OFF and remove him from a power source when you are not using him and before conducting maintenance.

Bob is not intended for use by persons (including children) with reduced physical or mental capabilities, or lack of experience and knowledge, unless under the close supervision of a person responsible for their safety.

Leaks from the battery cells can occur under extreme usage or temperature conditions. If the liquid gets on the skin, wash quickly with water. If the liquid gets into the eyes, flush them immediately with clean water for a minimum of 10 minutes, and seek medical attention.

Bob is composed of electronic components that in rare and unintended cases can cause hazards of heating, fire, and other malfunctions. Furthermore, because Bob is capable of autonomous movement, his use poses the risk of collision with property, pets, and persons. Unintended removal of articles — such as small valuables, jewelry, or hair of persons or pets lying on the floor — may also occur.

If Bob, his remote control, charging station, or bLOck Plus™ has been damaged in any way, do not operate them. Contact our helpful support team at [support@bobsweep.com](mailto:support@bobsweep.com) or 1-888-549-8847.

✗ Do not handle Bob, his FullCommand™ remote, charging station, or bLOck Plus™ with wet hands; use only on dry surfaces.

✗ Do not pull or carry the charging station by the cord, use the cord as a handle, close a door on the cord, or pull the cord around sharp edges or corners. Keep the cord away from heated surfaces. To unplug the cord, grasp the plug, not the cord.

✗ Do not attempt to open the charging station. Repairs on the station should only be carried out by our qualified technicians.

✗ With the exception of the mopping cloth, do not immerse any part of Bob into water or other liquids.

✗ Do not mutilate or incinerate the battery, as it will explode at high temperatures.

✗ Do not use Bob outdoors.

✗ Do not expose Bob, his charging station, or remote control to temperatures higher than 113° F (45° C), moisture, or humidity.

✗ Do not dispose of your battery in fire. Old batteries should be recycled safely through your local recycler.

✗ Do not let Bob pick up anything that is burning or smoking, such as cigarettes, matches, or hot ashes.

## Declaration of Conformity

This device complies with Part 15 of the FCC rules. Operation is subject to the following two conditions: (1) this device may not cause harmful interference, and (2) this device must accept any interference received, including interference that may cause undesired operation. The manufacturer is not responsible for any radio or TV interference caused by unauthorized modifications or change to this equipment. Such modifications or change could void the user's authority to operate the equipment.

This equipment has been tested and found to comply with the limits for a Class B digital device, pursuant to part 15 of the FCC Rules. These limits are designed to provide reasonable protection against harmful interference in a residential installation. This equipment generates, uses, and can radiate radio frequency energy and, if not installed and used in accordance with the instructions, may cause harmful interference to radio communications. However, there is no guarantee that interference will not occur in a particular installation. If this equipment does cause harmful interference to radio or television reception, which can be determined by turning the equipment off and on, the user is encouraged to try to correct the interference by one or more of the following measures:

- Reorient or relocate the receiving antenna.
- Increase the separation between the equipment and receiver.
- Connect the equipment to an outlet on a circuit different from that to which the receiver is connected.
- Consult the dealer or an experienced radio/TV technician for help.

## Warranty

Every Bob PetHair Plus purchased from an authorized seller includes a 2-year limited warranty, 5-year subsidized repair plan, and lifetime of customer support. The warranty covers the battery, labor, and non-consumable parts; it does not cover postal charges and consumable parts such as brushes, filters, and mopping cloths.

To activate Bob's warranty, register him online at [www.bobsweep.com/warranties](http://www.bobsweep.com/warranties). To purchase additional coverage plans, go to [www.bobsweep.com/coverageplan](http://www.bobsweep.com/coverageplan).

# Table of Contents

---

## 4 Getting Started

- 6. Box Contents
- 8. Bob's Anatomy
- 12. Get to Know Bob
- 14. Get Bob Started

---

## 36 FullCommand™ Remote

- 38. Remote Buttons
- 40. Syncing the Remote
- 42. Navigating Bob

---

## 78 Troubleshooting

- 80. Edge Sensors
- 82. Touch Sensors
- 84. Obstacle / Wall Sensors
- 86. Main Brush
- 88. Left Wheel
- 90. Right Wheel
- 92. Dustbin
- 94. Power System
- 96. (No Part Name)

---

## 24 Cleaning Modes

---

## 44 Cleaning Schedule

- 46. Setting the Current Time and Day
- 48. Setting the Cleaning Schedule
- 50. Auto-Resume Mode

---

## 98 Home Checkup Test

- 100. Checkup Mode
- 102. Edge Sensors
- Obstacle / Wall Sensors
- Touch Sensors
- Charging Station
- 104. bLock Plus™
- Display Screen
- Brush / Suction Power
- UV Light / Wheels

---

## 28 Charging

- 30. Charging Bob
- 32. Charging Station
- 34. Syncing the Charging Station

---

## 52 Maintenance

- 54. Dustbin
- 56. Filter
- 58. Main Brush
- 60. Side Brush
- 62. Sensors

---

## 106 FAQs

---

## 112 End User License Agreement

---

## 64 Parts and Accessories

- 66. bLock Plus™
- 72. Mop
- 74. Edge Sensors
- 76. Battery

# Getting Started

Let's start at the very beginning.

We'll walk you through the basics and help you get Bob started for the very first time.

- 6 Box Contents
- 8 Bob's Anatomy
- 12 Get to Know Bob
- 14 Get Bob Started



Bob comes with the following items. You can purchase replacement parts and accessories at [www.bobsweep.com/shop](http://www.bobsweep.com/shop).

- |  |  |
|--|--|
| <b>1</b> FullCommand™ Remote           | <b>9</b> Screws (1 Main Brush Screw, 2 Side Brush Screws)      |
| <b>2</b> Charging Adapter              | <b>10</b> Cleaning Tool  |
| <b>3</b> Charging Station              | <b>11</b> Filters (2)  |
| <b>4</b> Mop Attachment                | <b>12</b> Main Brush   |
| <b>5</b> Microfiber Mopping Cloths (2) | <b>13</b> Side Brushes (2)                                     |
| <b>6</b> bLOck Plus™                   | <b>14</b> Owner's Manual, Quick Start Guide, and Warranty Card |
| <b>7</b> Flat Head Screwdriver         | <b>15</b> Bob PetHair Plus                                     |
| <b>8</b> Set of Bumper Stickers        |  |

Not Shown: bLOck Plus™ Non-Slip Stickers





### Top View

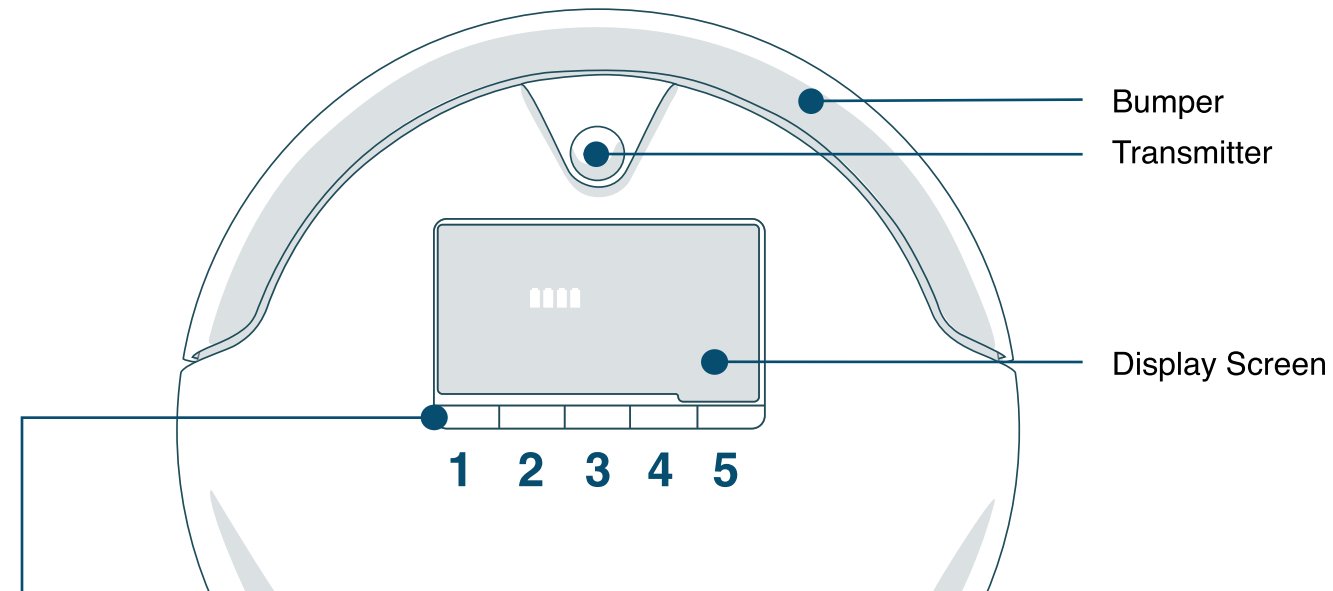

#### Cover Buttons

- 1** GO! - Sends Bob to clean.
- 2** CLEANING MODE - Cycles through Bob's cleaning modes.
- 3** CHARGE - Sends Bob to his charging station.
- 4** MUTE - Mutes or unmutes the beeps Bob makes while in standby mode.
- 5** CHECKUP - Puts Bob in checkup mode or deactivates his edge sensors.

### Bottom View

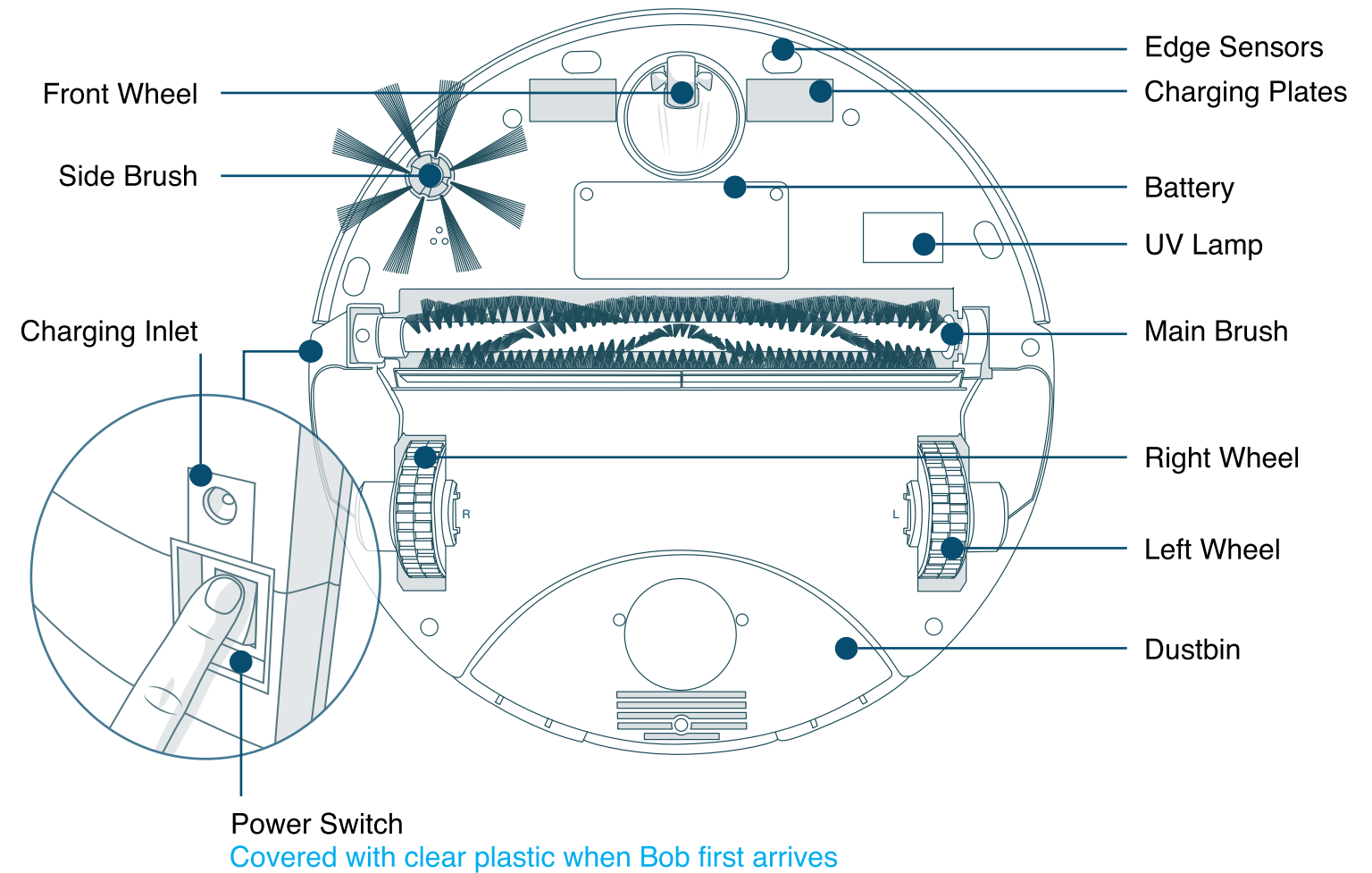

### Who is Bob?

Bob is an autonomous robotic vacuum cleaner, at your service! He can vacuum, sweep, and mop all the same time — and at the end of his cleaning session, he automatically returns to his charging station for a power nap. Set Bob to clean on a schedule and he'll clean on his own even when you're not around.

### How does Bob find his way around?

Bob doesn't store any data about your home; instead, he uses a network of reactionary sensors to detect obstacles. To maximize his coverage, he may spiral outward, zigzag across a small area, or follow along walls. If he seems to be ignoring some spaces or spending too much time on others, don't worry! Bob will efficiently clean your home over the course of a full cycle — just check his dustbin for the evidence!

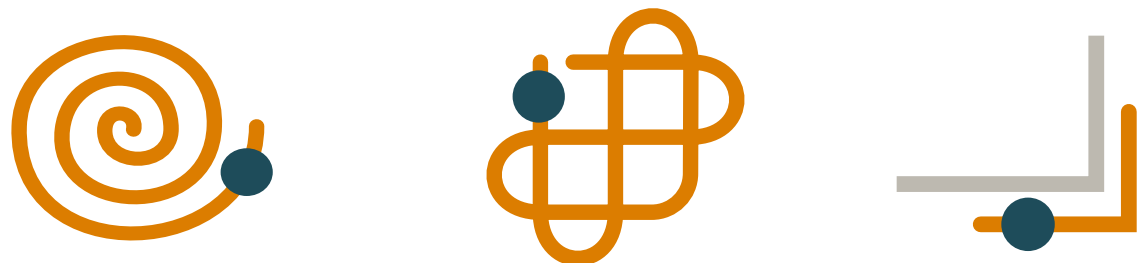

### Should I pick up Bob?

You may pick up Bob while he's cleaning, but it's best to let him work in his own way. Moving him around, manipulating his movements, or picking him up may confuse him and disrupt his cycle.

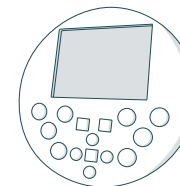

### FullCommand™ Remote

If you wish to control Bob's movements manually, you may use the navigational buttons on his remote.

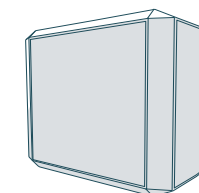

### bIOck Plus™

You can keep Bob away from obstacles that he finds difficult to navigate, such as areas with cords or high ledges, by using bIOck Plus™.

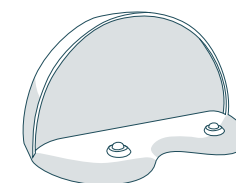

### Charging Station

Bob automatically returns to his charging station when low on battery. If Bob is having trouble finding his station, try re-syncing it and relocating it to a more easily accessible location with more space around it.

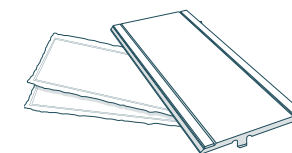

### Mop Attachment

Bob may have a tough time climbing over elevated surfaces while mopping. Remove Bob's mop when he is not cleaning smooth surfaces. Do not let him climb onto carpet or rugs when mopping.

## Navigating Difficult Obstacles



### Unique Furniture

Bob is designed to maneuver around furniture of most shapes and sizes, but he may find it difficult to clean under chairs with narrow legs or around furniture that is too low for his bumper sensors to detect. Specialty furniture, such as desk chairs with wheels or stools with circular bases, may also confuse him momentarily — but don't worry, Bob usually finds his way around with time.

### Dark-Colored Carpet

If Bob repeatedly backs up or displays a trouble message while cleaning dark carpet, then you'll need to deactivate the edge sensors. To do so, simply hold down the CHECKUP button on Bob's cover until the 4 bars above the word "checkup" flash 7 times and remain lit on his screen. Just remember that while Bob's edge sensors are deactivated, he will not be able to detect edges or stairs!

### Shag Carpet

Bob's main brush is not designed to clean shag carpet or rugs with long fibers. If you'd like Bob to clean shag carpet or long-fibered rugs, you may remove his main brush and allow him to vacuum without it.

### Inclines

Sometimes Bob will attempt to drive up angled surfaces, get stuck for a few minutes, and then decide to clean somewhere else. As long as Bob does not display a trouble message on his screen, let him continue cleaning and find his own way around. Take note of the areas Bob finds the most challenging and, if possible, adjust your furniture accordingly.

### Easy Fix

Use bLOck Plus™ to keep Bob away from areas he finds particularly challenging. bLOck Plus™ emits 2 digital barriers: one from its left side and one from its front side. You may use one or both barriers, depending on your preference.

## Step 1: Install Bob's Side Brush

Install Bob's side brush to help him reach the corners and edges of rooms.

Parts You'll Need:

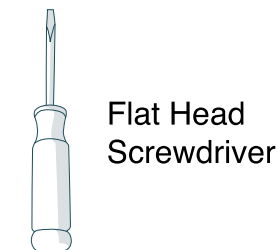

### Screw Guide:

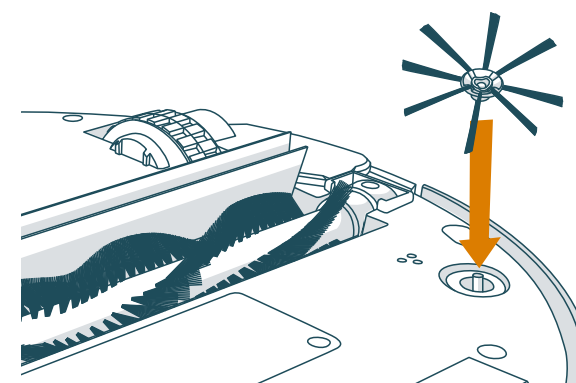
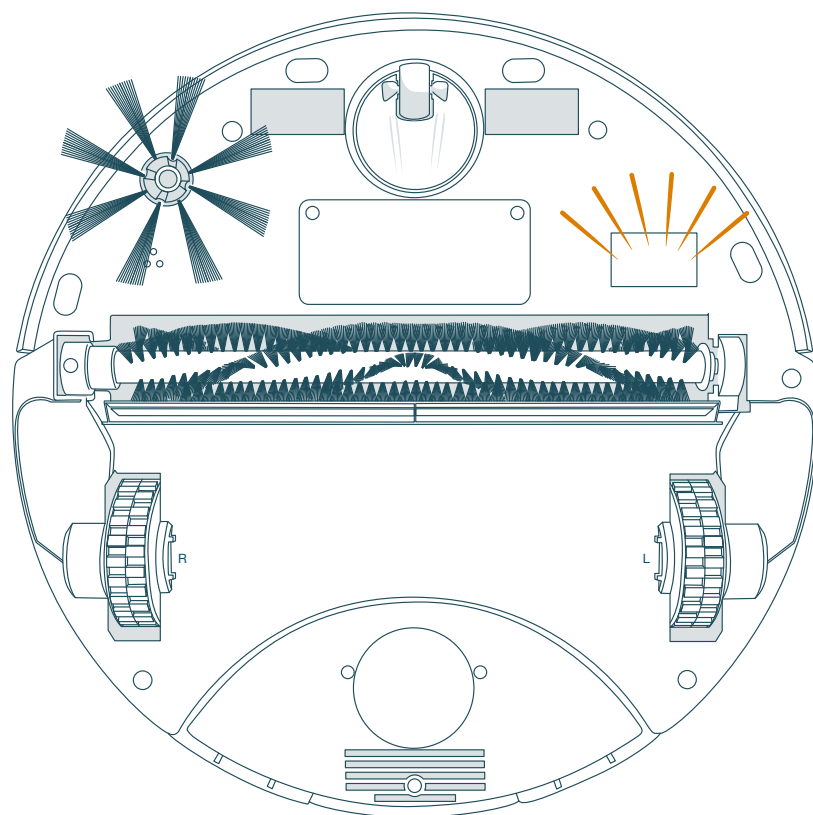
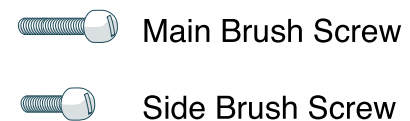

1. Flip Bob over onto a flat surface. Place the side brush over the empty socket on Bob's underside.

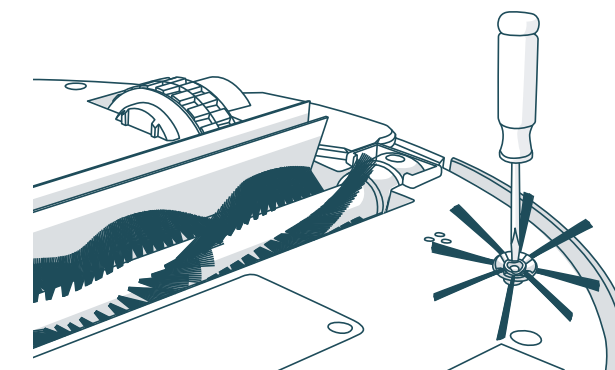

2. Secure Bob's side brush into the socket using the flat head screwdriver and screw.

### Quick Tip:

! Use the additional side brush and screw as spares.

## Step 2: Charge Bob

Allow Bob to fully charge before using him for the first time.

### Parts You'll Need:

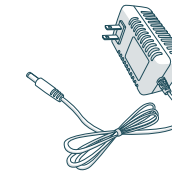

Charging Adapter

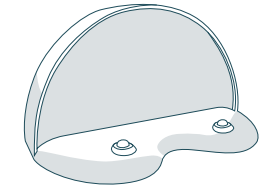

Charging Station

#### When Bob Is Charging:

The battery bars flash and the word "charging" is lit.

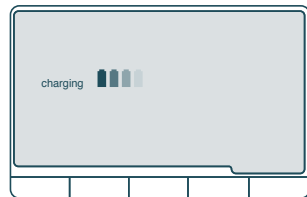

#### When Bob Is Fully Charged:

The battery bars remain still and the word "charging" is no longer lit.

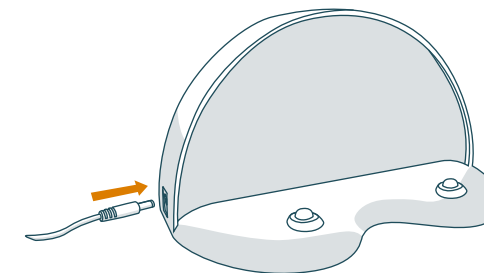
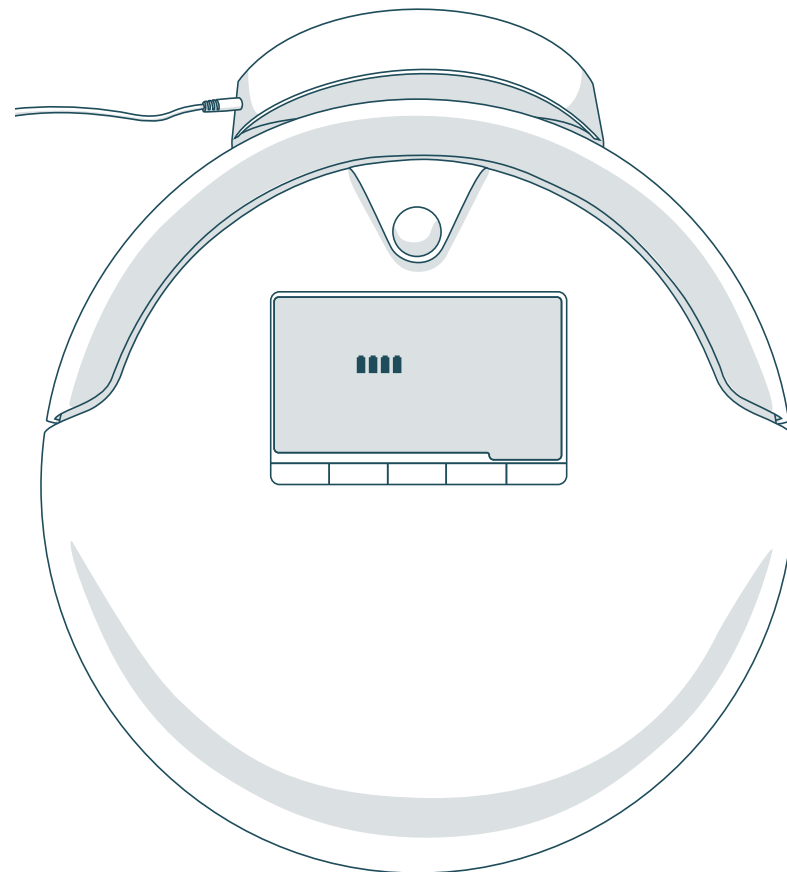

1. Plug the charging adapter into the side of the charging station. The station's red power light will turn on.

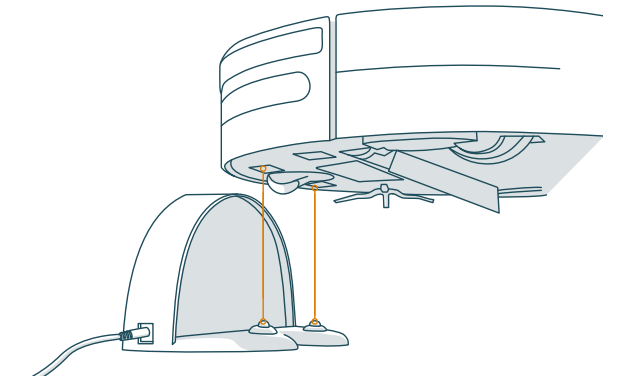

2. Place Bob on his charging station with the metal plates on his underside sitting on top of the nodes on his station.

## Step 3: Sync Bob's Remote

Sync Bob to his remote so that he can respond to its commands.

### Parts You'll Need:

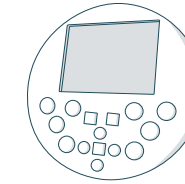

FullCommand™  
Remote

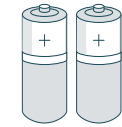

AAA Batteries x2  
(not included)

### Quick Tip:



Make sure to remove the clear plastic covering on the power switch.

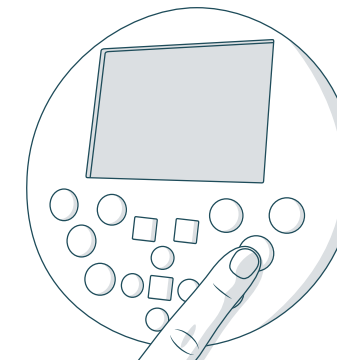
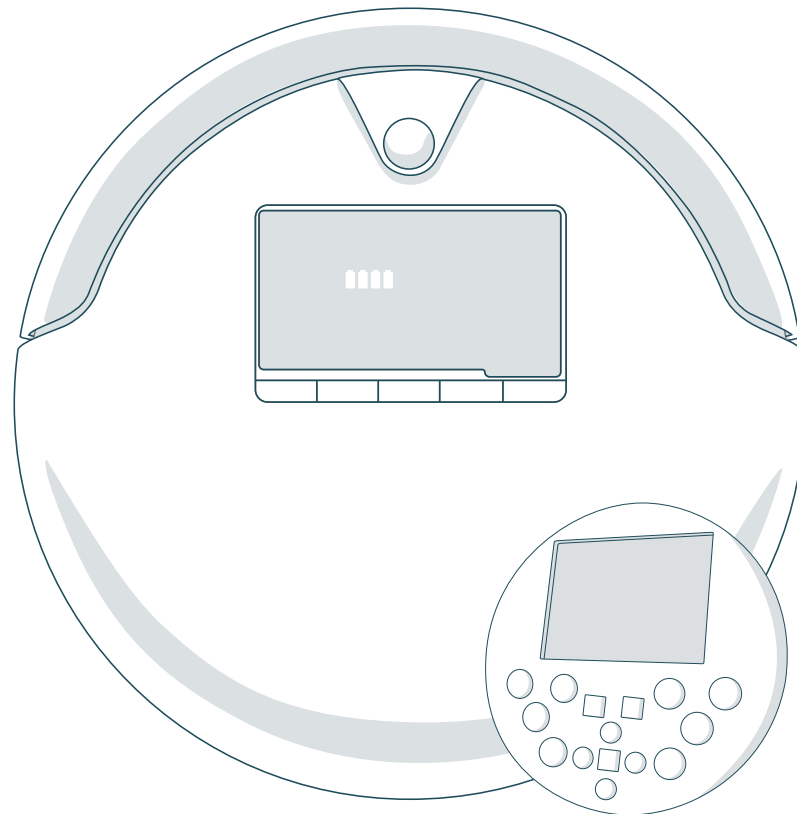

1. Hold down the OK/SYNC button on Bob's remote.

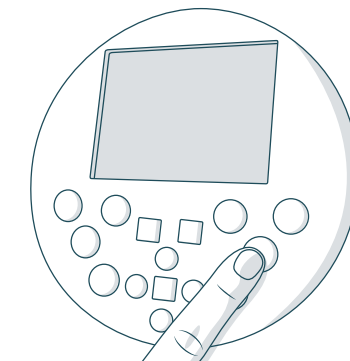

2. While still holding down the OK/SYNC button, flip Bob's power switch ON.

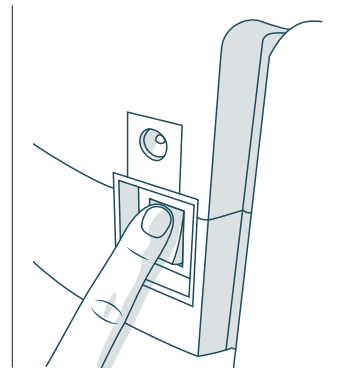

Bob will chirp twice to let you know the sync was successful. If Bob does not chirp, repeat the process.

## Step 4: Select Bob's Cleaning Power

Use Bob's remote to switch between power modes.

Parts You'll Need:

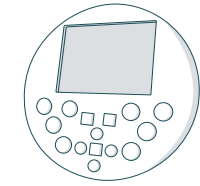

FullCommand™  
Remote

### Quick Tip:



Make sure Bob is  
powered ON.

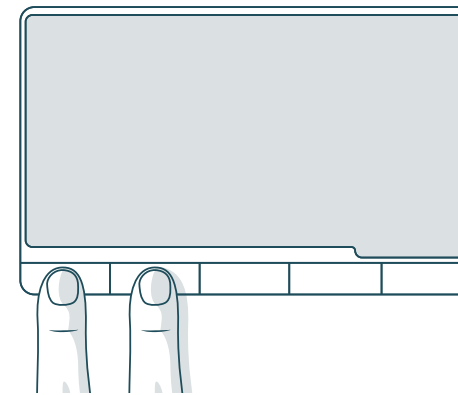
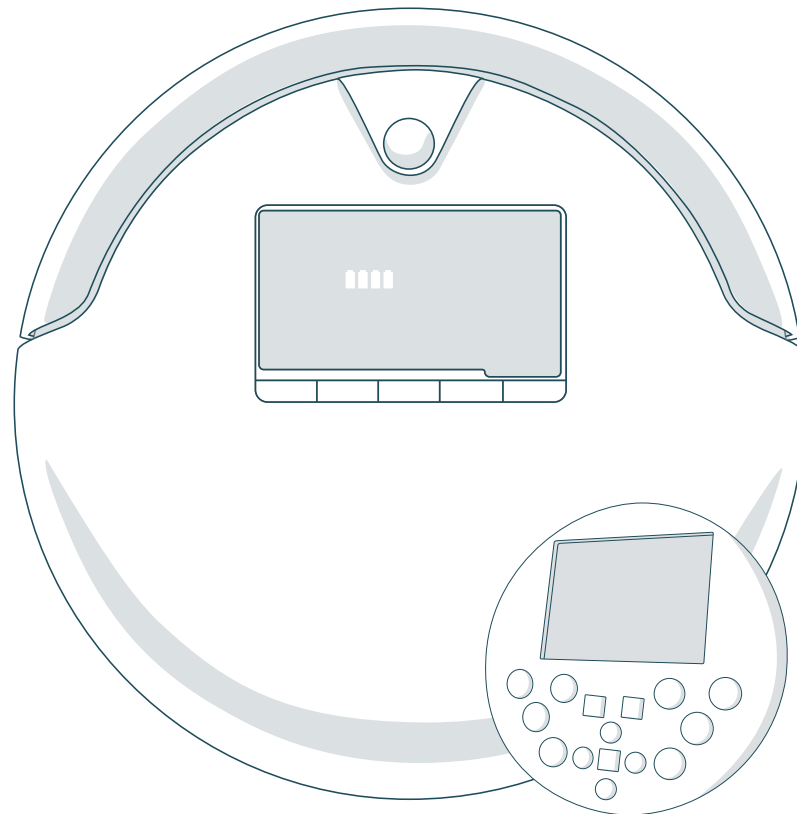

OR

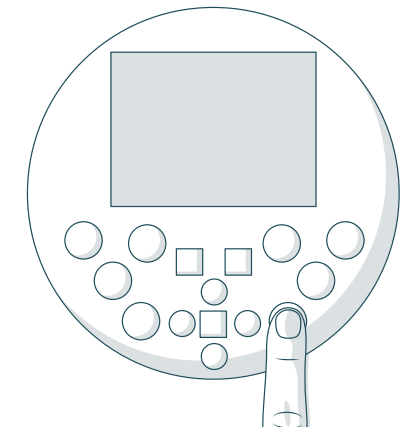

1. Simultaneously press the GO! and CLEANING MODE buttons on Bob's cover or press the ThoroughLift™ button on Bob's remote to boost Bob's cleaning power for an intensive clean.
2. Press the GO! and CLEANING MODE buttons on Bob's cover or press the ThoroughLift™ button on Bob's remote one more time, to return Bob to his default mode.

Bob is now ready to clean!

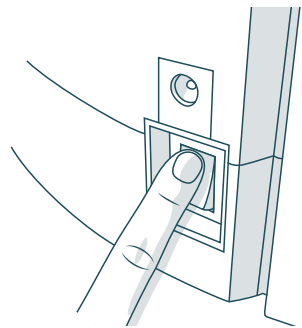

1. Flip Bob's power switch ON.

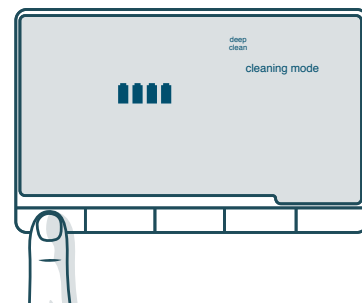

OR

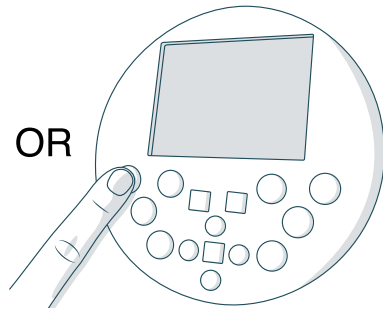

2. Press the GO! button on Bob's cover or FullCommand™ remote, and he will clean on his default Deep Clean mode.

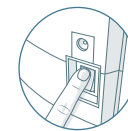
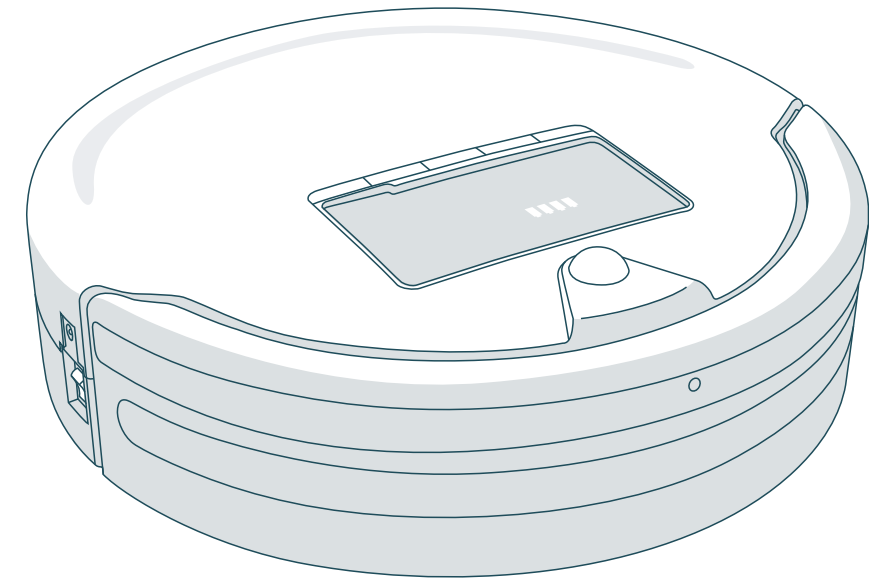

**Quick Tip:**

Make sure to remove the clear plastic covering on the power switch.



# Cleaning Modes

On his default Deep Clean mode, Bob thoroughly cleans a large area and returns to his charging station when low on battery.

If you'd like Bob to clean a smaller area, or if you'd like him to clean for a shorter amount of time, you may select his other cleaning modes.





Select the cleaning mode that best suits your needs.

Bob automatically returns to his charging station after he completes a cycle in each mode.

### Deep Clean (45 – 90 min)

Bob will thoroughly cover a large area until his battery power reaches 15%. Deep Clean is Bob's default cleaning mode.

To select it, press GO! on his cover or remote.

### Quick Clean (30 min)

Bob will cover a medium-sized area for 30 minutes.

### Touch Up (15 min)

Bob will cover a small area for 15 minutes.

### Waffle Track™

Bob will target a 6 x 5 ft (1.8 x 1.5 m) spill zone by tracing a grid pattern.

### Wall Track™

Bob will clean along the perimeter of your home.

## Selecting a Cleaning Mode

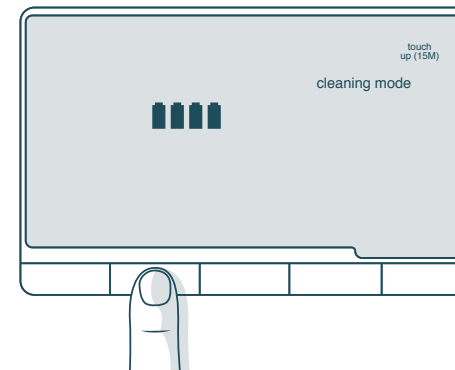

OR

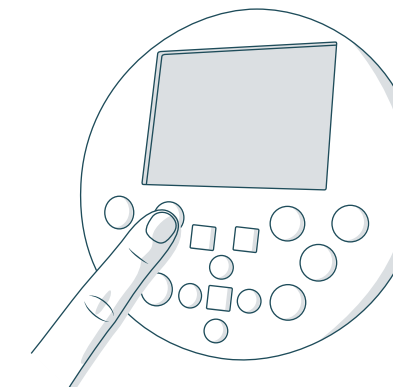

1. Press the CLEANING MODE button on Bob's cover or FullCommand™ remote until the mode you wish to select lights up on his screen.

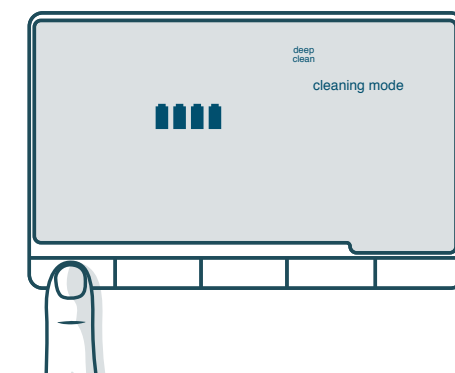

OR

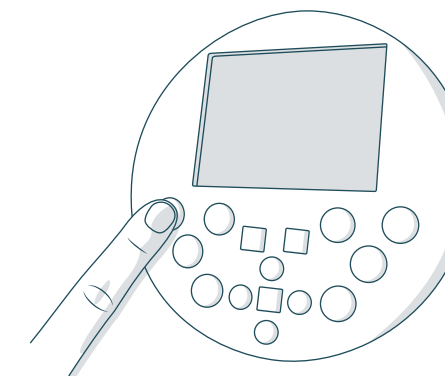

2. Press the GO! button on Bob's cover or remote to confirm your selection.

# Charging

Bob automatically returns to his charging station when low on battery. To maximize Bob's chance of finding his station, it's best to place it in an easily accessible location with plenty of space around it. If Bob continues to have trouble finding his station, you may need to sync it.

- 30** Charging Bob
- 32** Charging Station
- 34** Syncing the Charging Station



## Charging Bob

### Charging Bob Using the Charging Station

Place Bob on his charging station with the metal plates on his underside sitting on top of the nodes on his station. Make sure the station is plugged in and the station's red power light is on.

### Charging Bob Using the Adapter

Plug the charging adapter directly into the inlet on Bob's side.

### Sending Bob to His Charging Station

Press the CHARGE button on his FullCommand™ remote or cover.

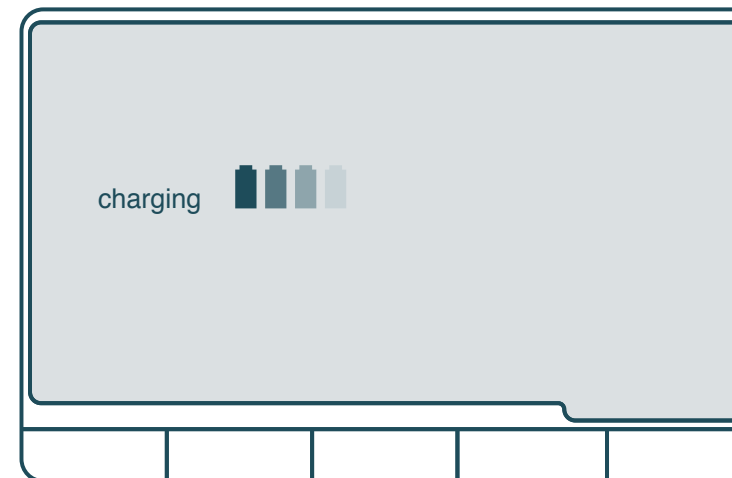

#### When Bob Is Charging:

The battery bars flash and the word “charging” is lit.

#### When Bob Is Fully Charged:

The battery bars remain still and the word “charging” is no longer lit.

### Charging Station

Position the charging station against a wall on a hard, flat surface. Make sure there is at least 10 feet (3 m) of open space to the front and 2 feet (0.6 m) of open space to the sides of the station.

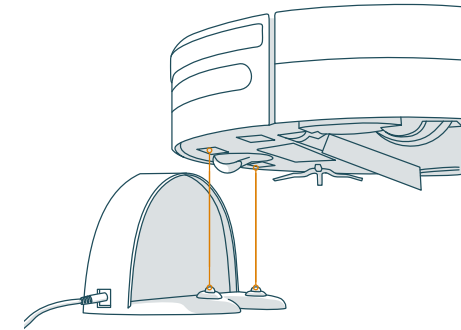
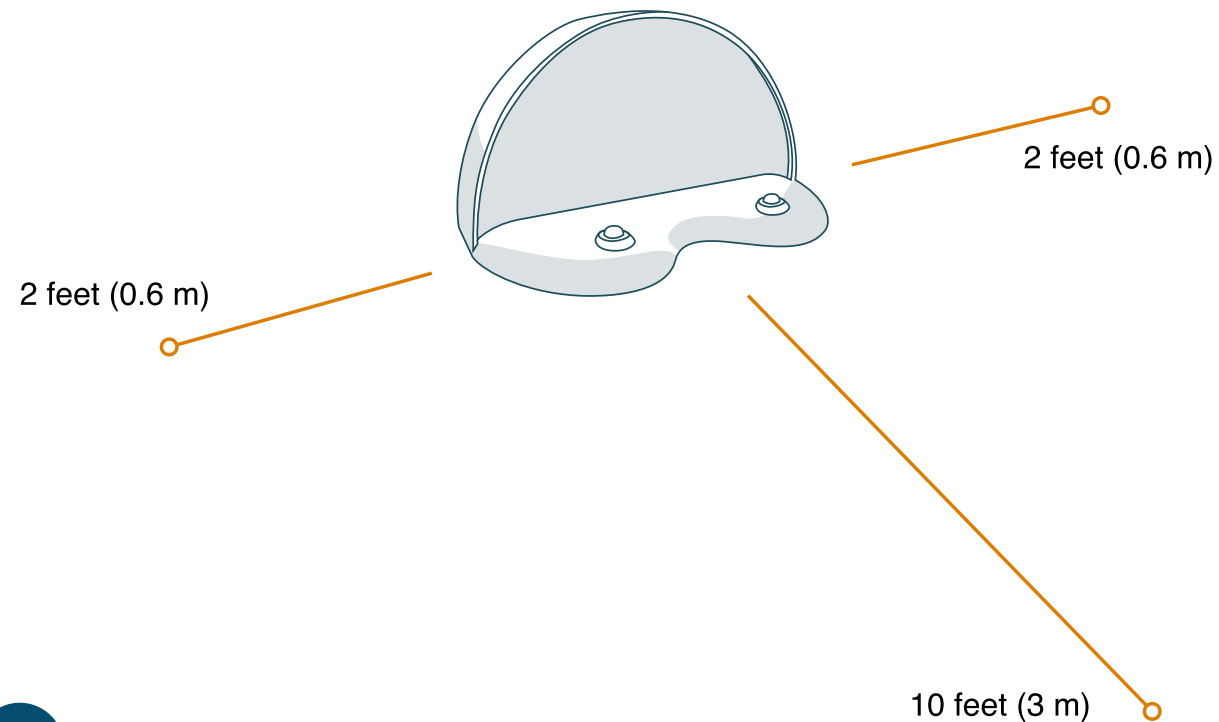

### Conserving Bob's Battery

To conserve Bob's battery, turn his power switch OFF and remove him from his charging station when he is not in use. Bob should not sit on his station for more than 5 days.

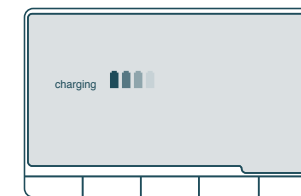

When Bob is charging, the battery bars on his display screen flash and the word "charging" is lit.

When Bob is fully charged, the battery bars remain still and the word "charging" is no longer lit.

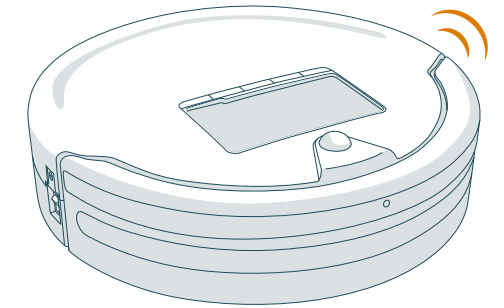

### Standby Mode

After a minute of idling with his power switch ON, Bob will enter standby mode to conserve his battery. In standby mode, Bob's screen will be blank, and he will beep once every 2 minutes. To mute the beeps Bob makes in standby mode, press the MUTE button on his cover or FullCommand™ remote.

### Syncing the Charging Station

Bob is smart and will automatically search for his charging station when his battery power reaches 15%. You will need to sync the station if Bob is having trouble finding it.

#### Parts You'll Need:

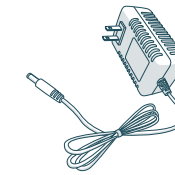

Charging Adapter

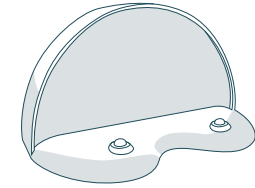

Charging Station

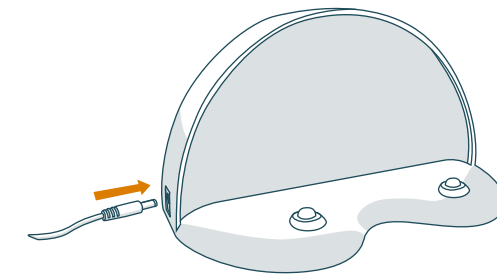
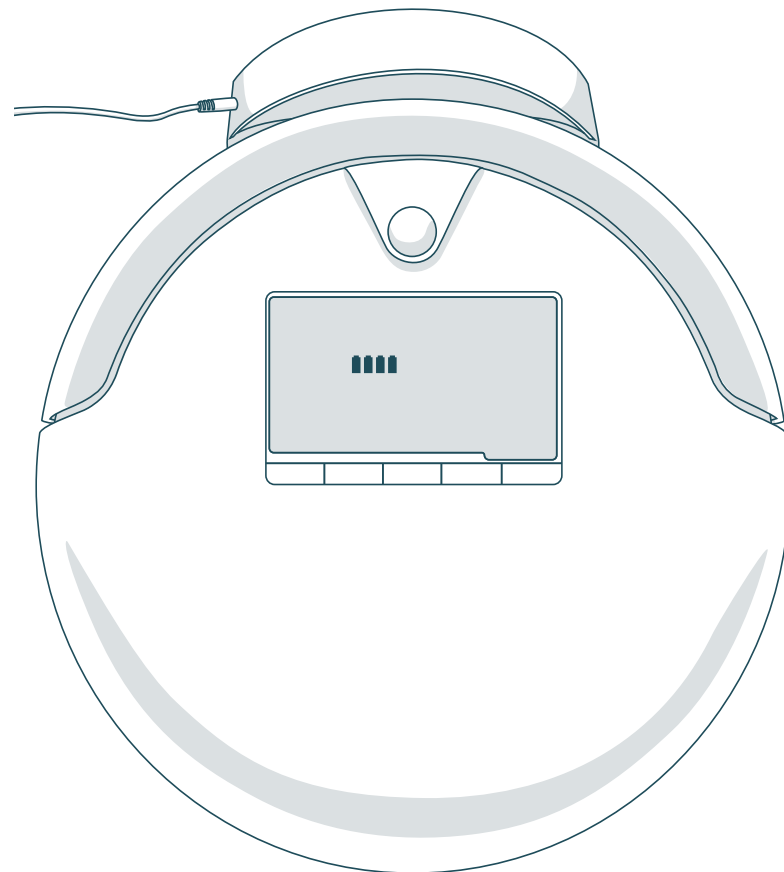

1. Plug the charging adapter into the side of the charging station. The station's red power light will turn on.

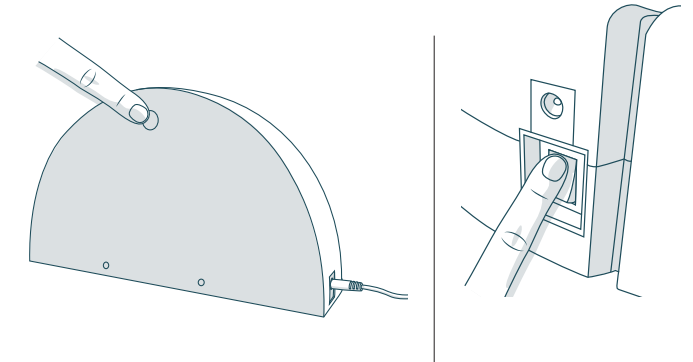

2. Hold down the SYNC button on the back of the charging station while at the same time flipping Bob's power switch ON.

#### Quick Tip:

! Make sure Bob is not on the charging station during the sync.



Bob will chirp twice to let you know the sync was successful. If Bob does not chirp, repeat the process.

# FullCommand™ Remote

You can set Bob's cleaning schedule, select his cleaning modes, and control his movements all from his FullCommand™ remote.

- 38 Remote Buttons
- 40 Syncing the Remote
- 42 Navigating Bob



### Remote Buttons

- 1** GO!  
Sends Bob to clean.
- 2** Charge  
Sends Bob to his charging station.
- 3** UV Light  
Activates or deactivates the UV light.
- 4** Cleaning Mode  
Cycles through Bob's cleaning modes from Deep to Quick Clean and more.
- 5** Wake/Sleep  
Puts Bob in and out of standby mode.
- 6** Mute  
Mutes or unmutes the beeps Bob makes while in standby mode.
- 7** Set Current Time  
Sets the current time and day.
- 8** Set Cleaning Schedule  
Sets Bob's cleaning schedule.
- 9** OK/Sync  
Confirms time selection or synchronizes the remote.
- 10** Thorough Lift™  
Boosts power & reduces speed for an intensive clean, or increases speeds and lowers power to default.
- 11** Stop  
Pauses or resumes Bob's movements.
- 12** Navigational Buttons  
Guide Bob forward, backward, right, or left.

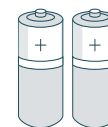
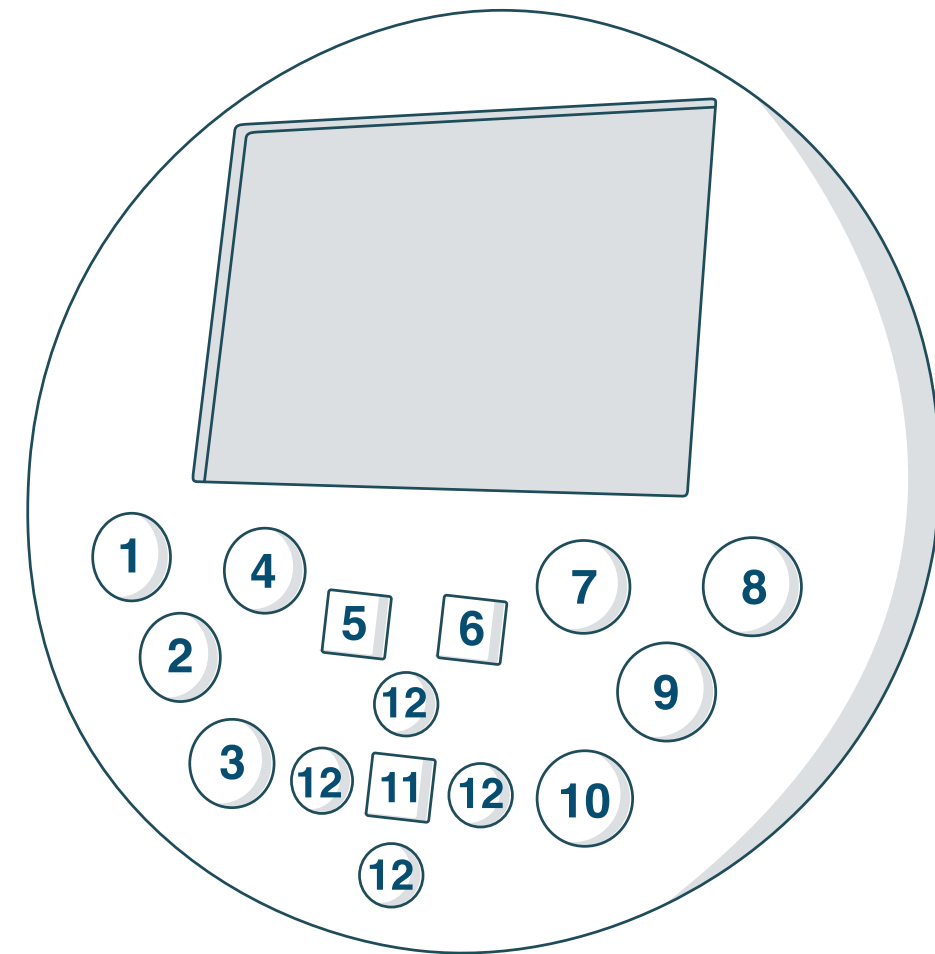

Bob's FullCommand™ remote requires 2 AAA batteries (not included). Remove the batteries if you are not using the remote on a regular basis. Keep the remote at room temperature.



### Syncing the Remote

Bob must be synced to his FullCommand™ remote before he is able to obey its commands.

#### Parts You'll Need:

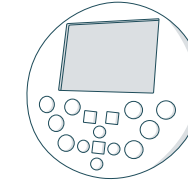

FullCommand™ Remote

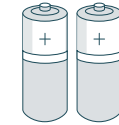

AAA Batteries x2 (not included)

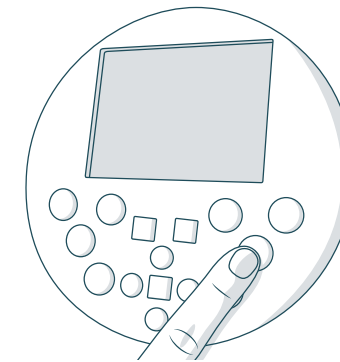
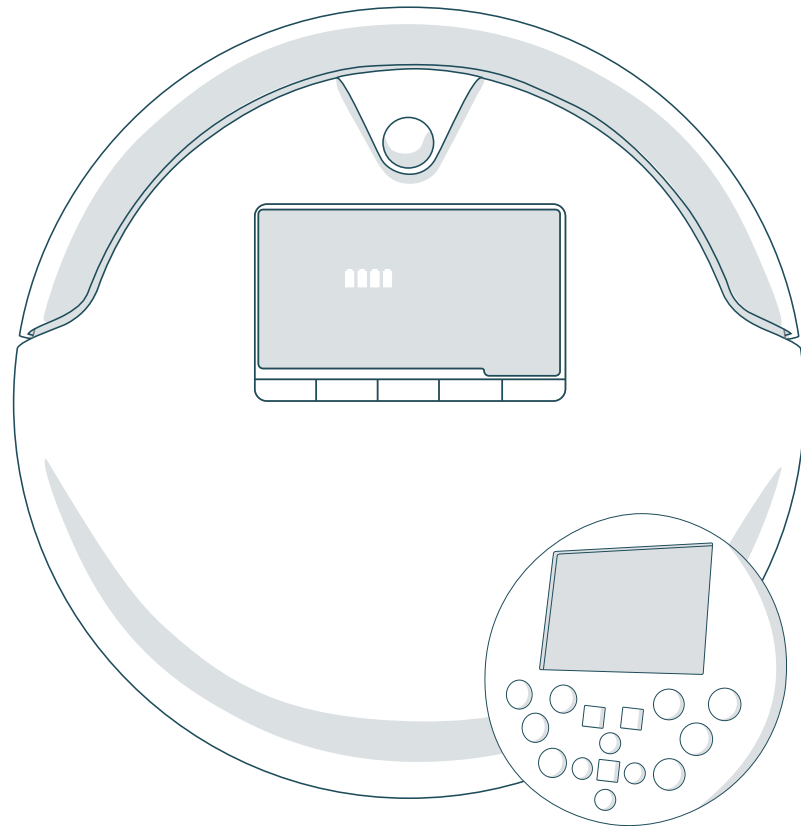

1. Hold down the OK/SYNC button on Bob's remote.

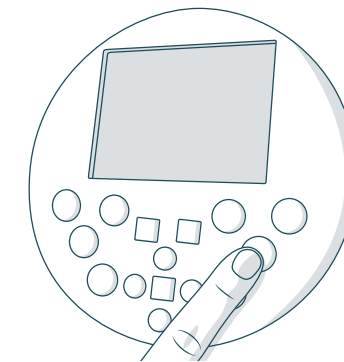

2. While still holding down the OK/SYNC button, flip Bob's power switch ON.

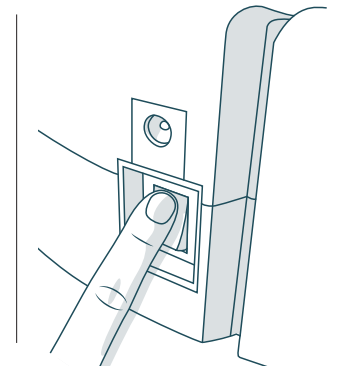

Bob will chirp twice to let you know the sync was successful. If Bob does not chirp, repeat the process.

### Navigating Bob

Hold down a navigational button on the remote to keep Bob moving in the desired direction.  
Release the button when you are done manually driving Bob.

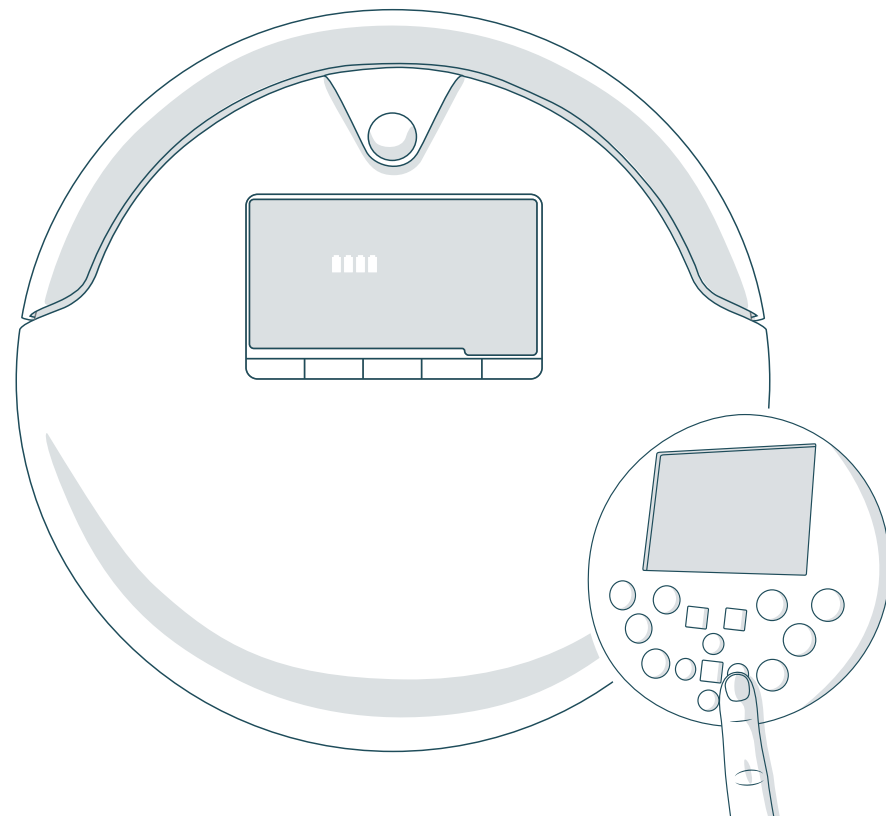

#### Quick Tip:

- ⓪ Bob's edge sensors are located along his front, not along his back. Do not reverse Bob towards edges, as he will fall.

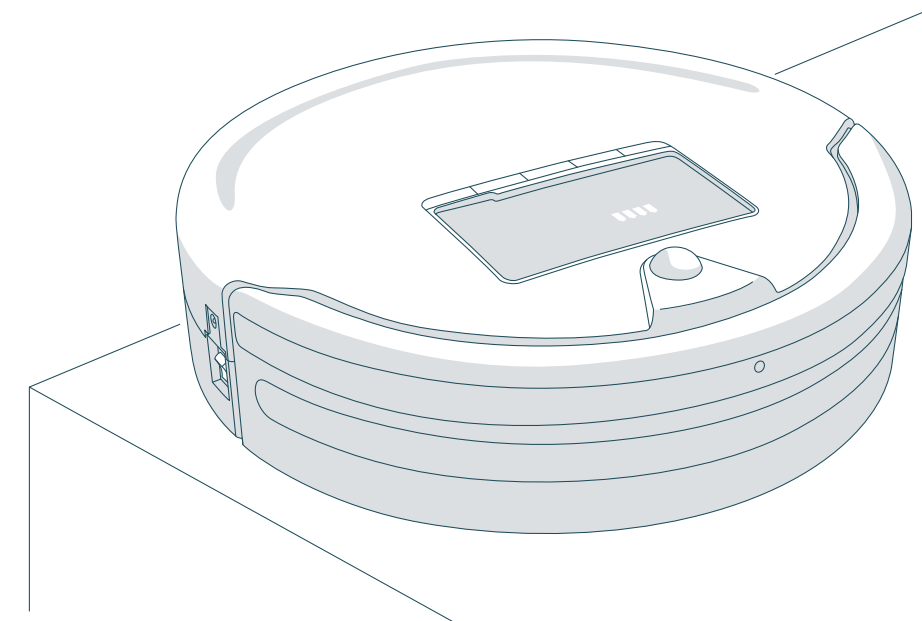

# Cleaning Schedule

Bob can be programmed to clean at the same time on multiple days of the week through his FullCommand™ remote. The remote works on a 24-hour clock, so adjust accordingly.

- 46 Setting the Current Time and Day
- 48 Setting the Cleaning Schedule
- 50 Auto-Resume Mode



### Setting the Current Time and Day

Bob can be programmed to clean at the same time on multiple days of the week through his FullCommand™ remote. To set Bob's cleaning schedule, you must first set the current time and day on his remote. Make sure Bob is turned ON and synced to his remote before proceeding.

#### Parts You'll Need:

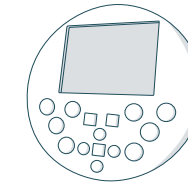

FullCommand™  
Remote

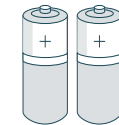

AAA Batteries x2  
(not included)

The remote works on a 24-hour clock, so adjust accordingly.

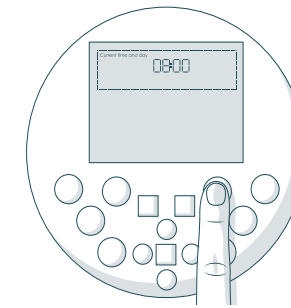
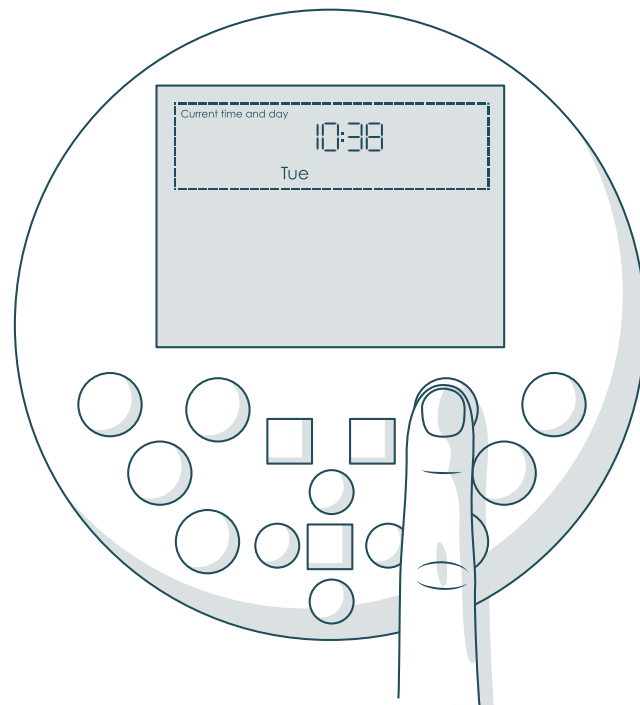

1. Press the SET CURRENT TIME button on the remote. The first hour digit will start flashing.

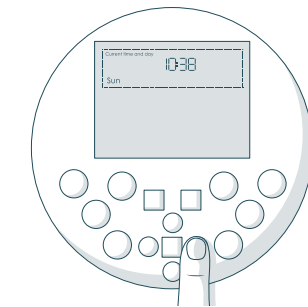

2. Use the LEFT and RIGHT buttons to move between minutes, hours, and days of the week. Use the FWD and BACK buttons to adjust your selection.

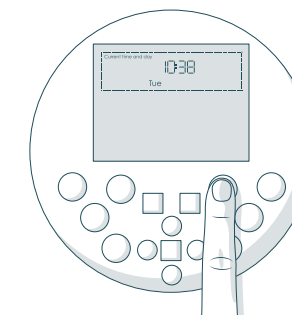

3. Press the SET CURRENT TIME button again to save your settings. Bob will chirp to confirm your save.

### Setting the Cleaning Schedule

Bob can be programmed to clean at the same time on multiple days of the week through his FullCommand™ remote. After setting the current time and day on Bob's remote, you may set his cleaning schedule. Make sure Bob is turned ON and synced to his remote before proceeding.

#### Parts You'll Need:

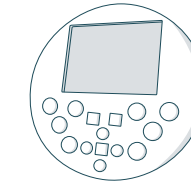

FullCommand™ Remote

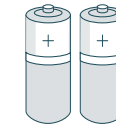

AAA Batteries x2 (not included)

The remote works on a 24-hour clock, so adjust accordingly.

#### Important to Note:

 The remote keeps its cleaning schedule for 4 hours after the batteries are removed.

#### Quick Tip:

 To clear Bob's schedule, press the SET CLEANING SCHEDULE button and go through each day of the week, pressing OK/SYNC to deselect. The days of the week that are selected will be lit.

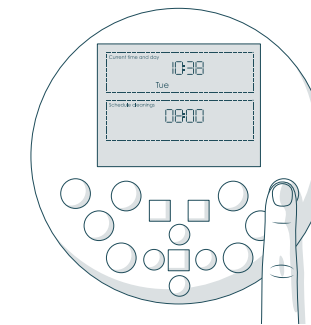
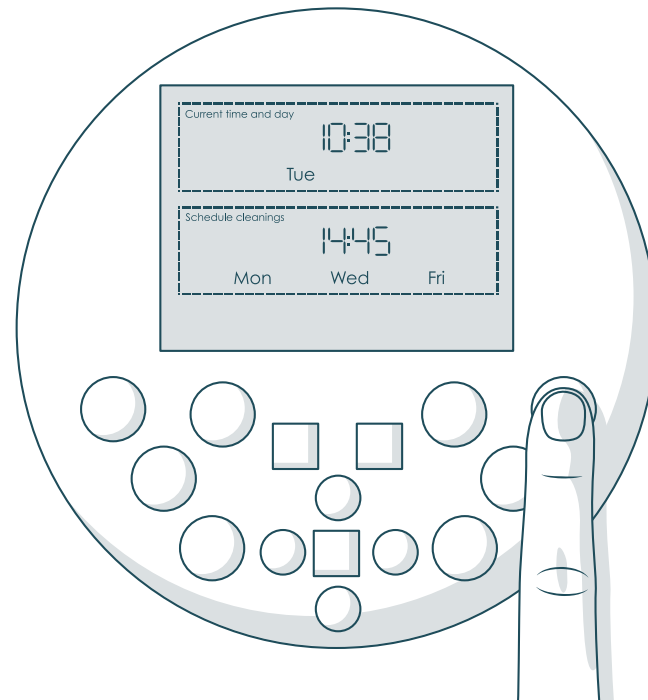

1. Press the SET CLEANING SCHEDULE button on the remote. The first hour digit will start flashing.

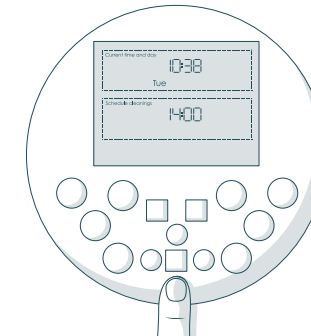

2. Use the LEFT and RIGHT buttons to move between minutes, hours, and days of the week. Use the FWD and BACK buttons to adjust your selection.

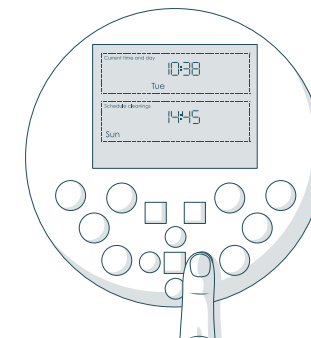

3. Press the OK/SYNC button to select or deselect days of the week. The days of the week that are selected will be lit.

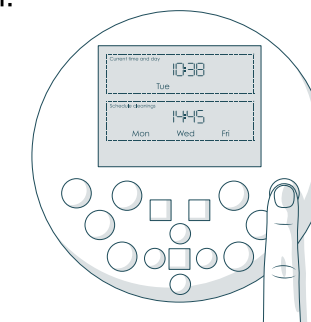

4. Press the SET CLEANING SCHEDULE button again to save your settings. Bob will chirp to confirm your save.

### Auto-Resume Mode

On auto-resume mode, Bob leaves his charging station after every recharge to perform “back-to-back” cleaning cycles. To enable auto-resume, make sure Bob is turned ON and synced to his FullCommand™ remote.

### Parts You'll Need:

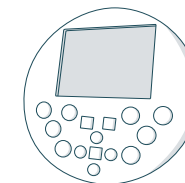

FullCommand™ Remote

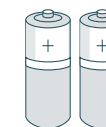

AAA Batteries x2 (not included)

### Enabling Auto-Resume

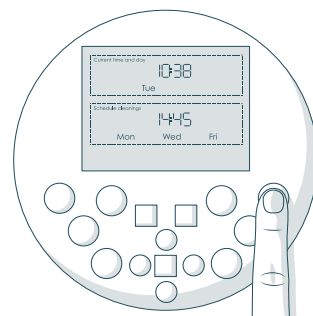
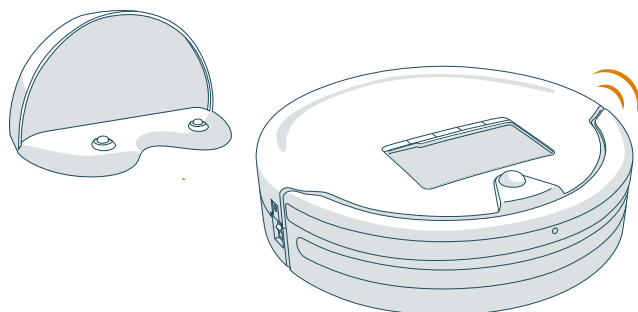

1. Press the SET CLEANING SCHEDULE button on the remote.

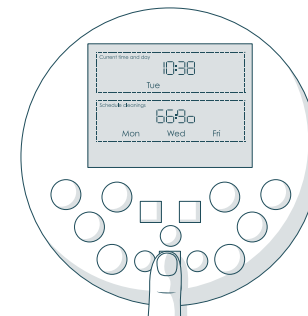

2. Press the STOP button and “bbgo” (back-to-back go) will appear on the remote’s screen.

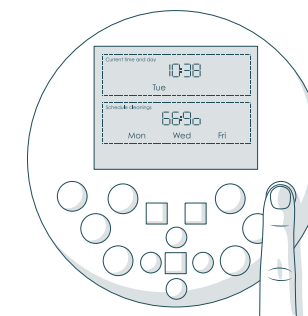

3. Press the SET CLEANING SCHEDULE button again to save your settings.

### Disabling Auto-Resume

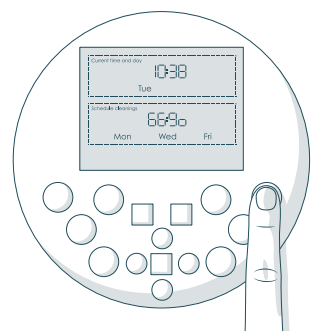
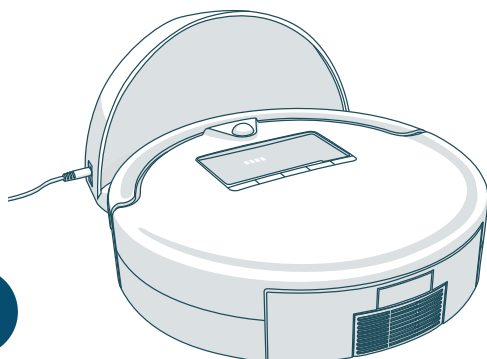

1. Press the SET CLEANING SCHEDULE button on the remote.

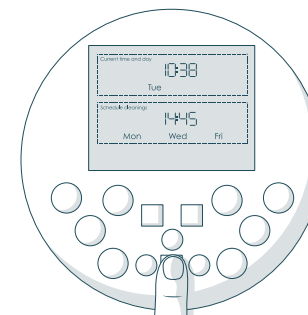

2. Press the STOP button and “bbgo” will reset to the last saved time.

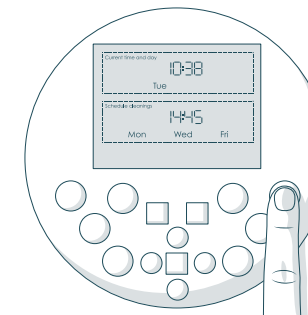

3. Press the SET CLEANING SCHEDULE button again to save your settings.

# Maintenance

To maximize Bob's efficiency, it is best to clean his dustbin, filters, brushes, and sensors about once a week.

- 54 Dustbin
- 56 Filter
- 58 Main Brush
- 60 Side Brush
- 62 Sensors



### Dustbin

To maximize Bob's efficiency, it is best to empty his dustbin about once a week, or about once every 6 cleaning cycles.



Parts You'll Need:



Cleaning Tool

### Emptying Bob's Dustbin

#### Quick Tips:

-  Never fill the dustbin with water or any other liquid.
-  Do not force the dustbin gate past its natural opening point.
-  Make sure the filters do not fall out of the dustbin as you empty it.

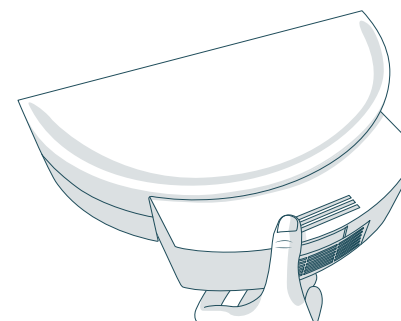
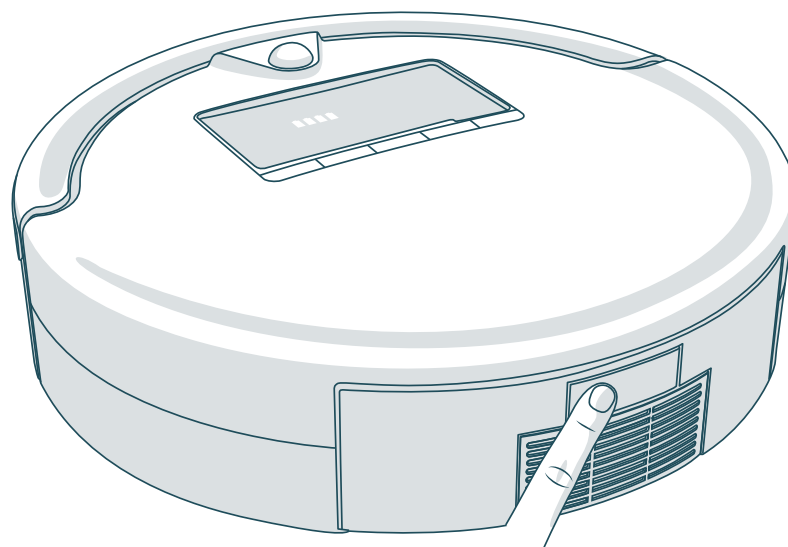

1. Push the button on Bob's back and slide the dustbin out.

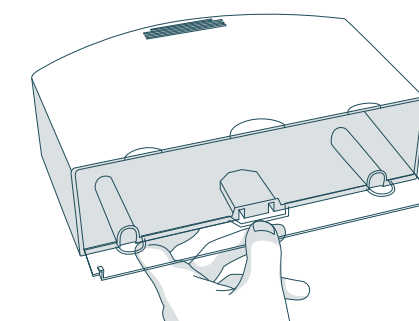

2. Carefully open the plastic gate and dump out the contents of the dustbin.

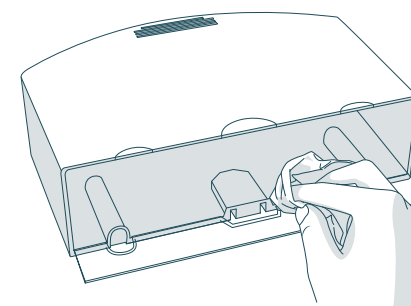

3. Wipe the dustbin with a dry cloth or brush it with Bob's cleaning tool.

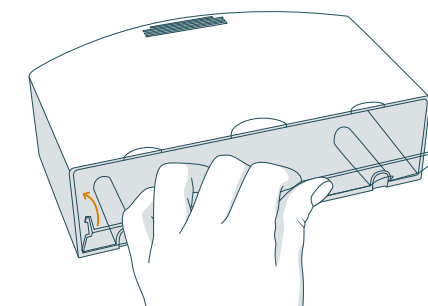

4. Carefully close the gate and slide the dustbin back into Bob.



## Filters

To maximize Bob's efficiency, it is best to clean his filters about once a week and replace them about once every 6 months. 3 filters are located inside the roof of the dustbin. These filters capture fine particles and prevent them from escaping the dustbin.

Parts You'll Need:

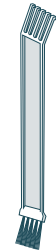

Cleaning Tool

## Cleaning Bob's Filters

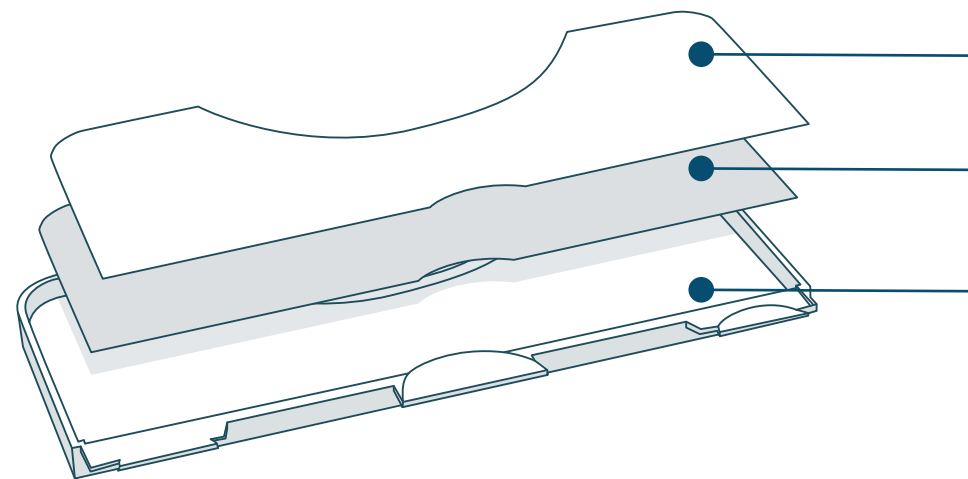

High-Efficiency Filter  
For fine particles

Electrostatic Filter  
For smaller particles

Mesh Filter (Filter Frame)  
For larger particles

### Quick Tip:



Never fill the dustbin with water or any other liquid.

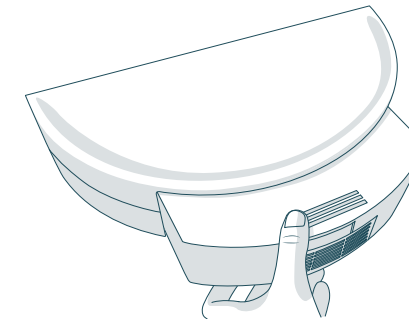

1. Push the button on Bob's back and slide the dustbin out.

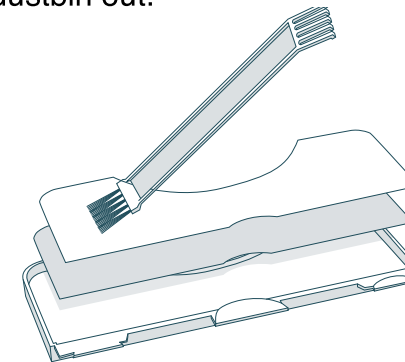

3. Remove the filters and brush them with Bob's cleaning tool.

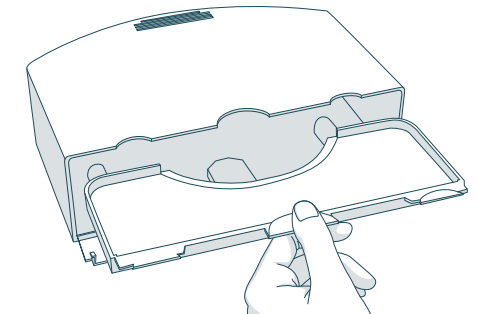

2. Pull out the filter frame from the roof of the dustbin.

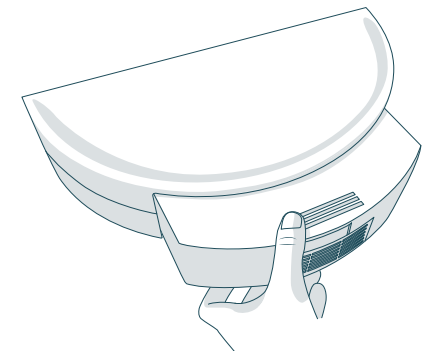

4. Replace the filters and slide the dustbin back into Bob.

### Main Brush

To maximize Bob's efficiency, it is best to clean his main brush about once a week.

#### Parts You'll Need:



Flat Head  
Screwdriver

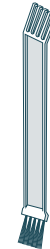

Cleaning Tool

### Cleaning Bob's Main Brush

#### Quick Tip:



You may use scissors to cut away entanglements of hair, or tweezers to unclog the notches inside Bob.

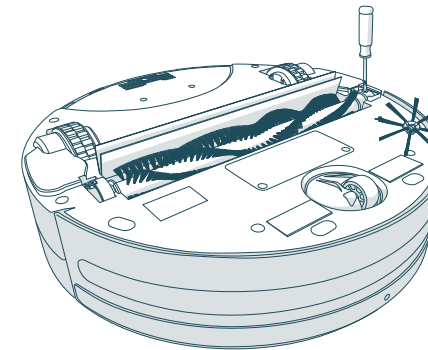
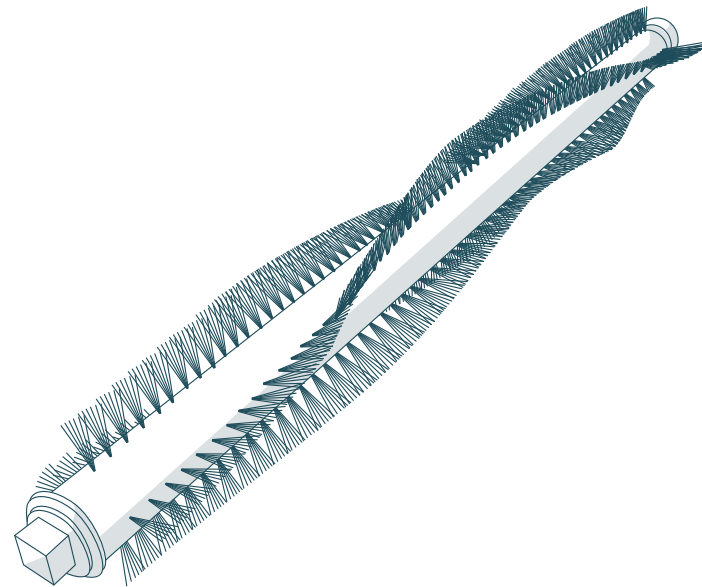

1. Remove the screw on the main brush using a flat head screwdriver.

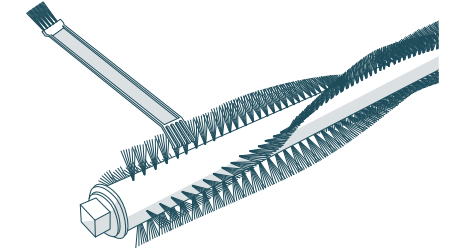

2. Clean the brush and the brush compartment from end to end using Bob's cleaning tool.

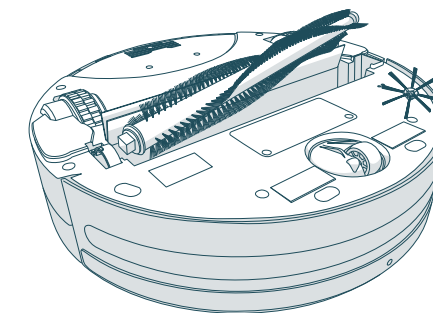

3. When done, replace the brush cap and insert the square end of the brush into the square notch inside Bob. Lastly, replace the screw.

### Side Brush

To maximize Bob's efficiency, it is best to clean his side brush about once a week.

#### Parts You'll Need:



Flat Head  
Screwdriver



Cleaning Tool

### Cleaning Bob's Side Brush

#### Quick Tip:



You may use scissors to cut away entanglements of hair, or tweezers to unclog the notches inside Bob.

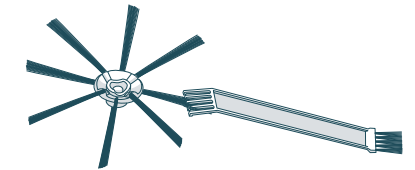
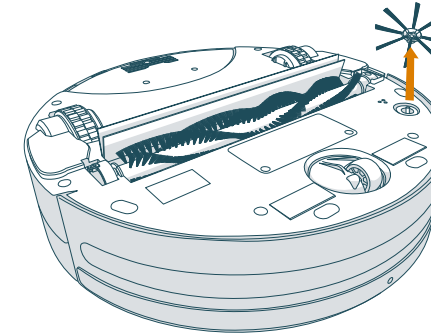
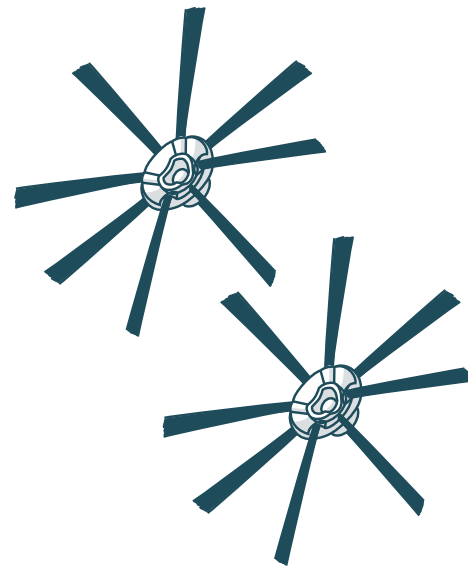

1. Remove the screw on the side brush using a flat head screwdriver.

2. Clean the brush and the brush socket using Bob's cleaning tool.

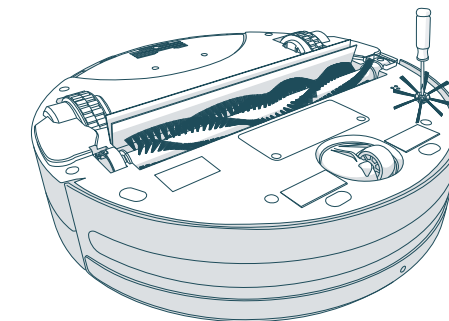

3. When done, replace the side brush and screw.

### Sensors

To maximize Bob's efficiency, it is best to clean his sensors about once a week. Bob's obstacle/wall sensors are located along his bumper; his edge sensors are located along the front of his underside.

Parts You'll Need:

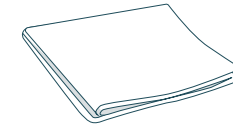

Cloth  
(not included)

### Cleaning Bob's Sensors

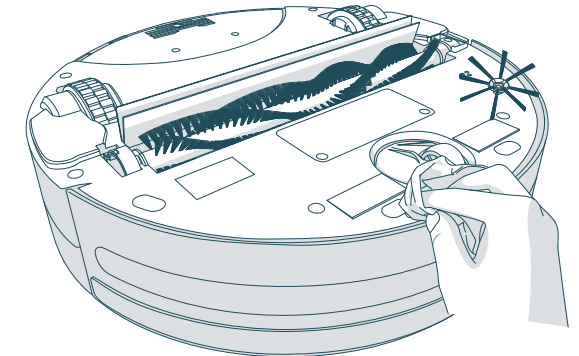
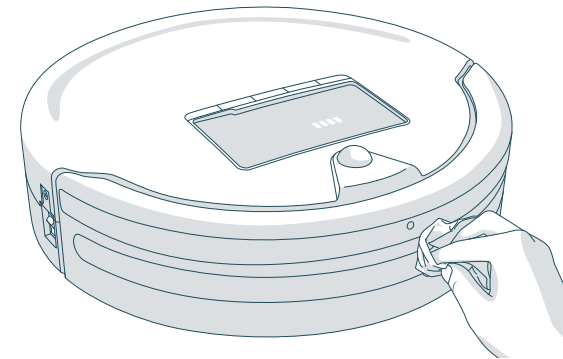
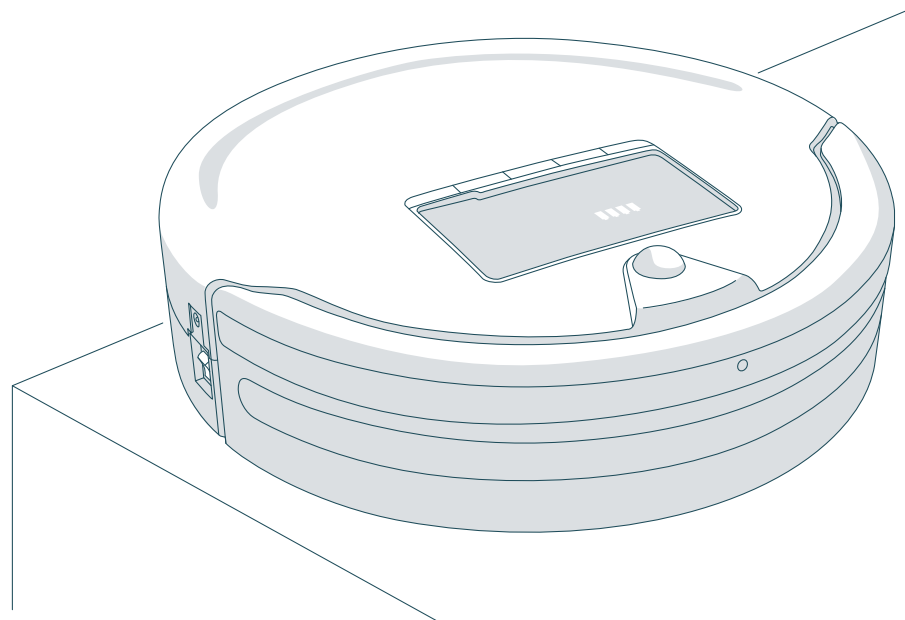

1. Wipe the obstacle/wall and edge sensors with a soft cloth slightly dampened with cold water or alcohol.

# Parts and Accessories

Bob's additional features include bOck Plus™, a mop attachment, edge sensors, and a lithium-ion battery. You can use bOck Plus™ to create digital barriers that Bob will not cross. You can deactivate Bob's edge sensors so he is better able to clean dark-colored carpet.

- 66 bOck Plus™
- 72 Mop
- 74 Edge Sensors
- 76 Battery



## bOck Plus™

You can use bOck Plus™ to create digital barriers that Bob will not cross. bOck Plus™ emits 10 foot barriers from its front and left sides. You may use the front barrier or both barriers depending on your preference. As with Bob's remote, you will need to sync bOck Plus™ before using it for the first time.

### bOck Plus™ Buttons



- 1** Left Power Button  
Turns front barrier on or off.

**Quick Tip:**  
The front barrier must be turned on before the left barrier can be turned on.

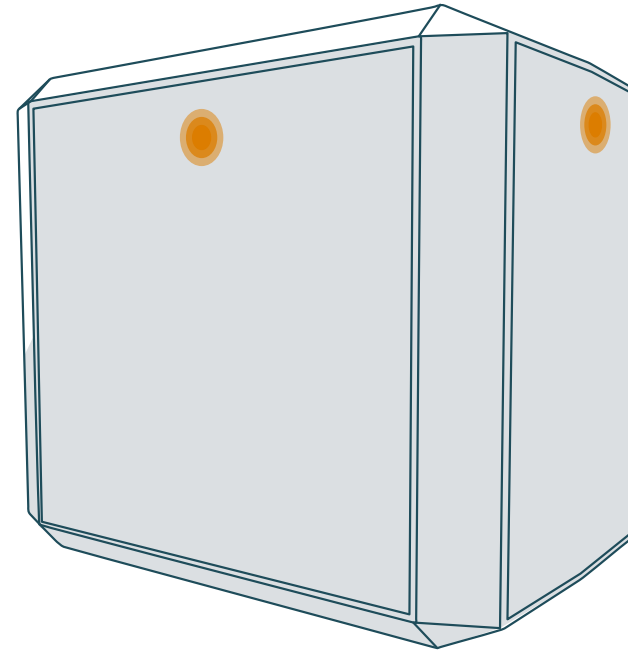
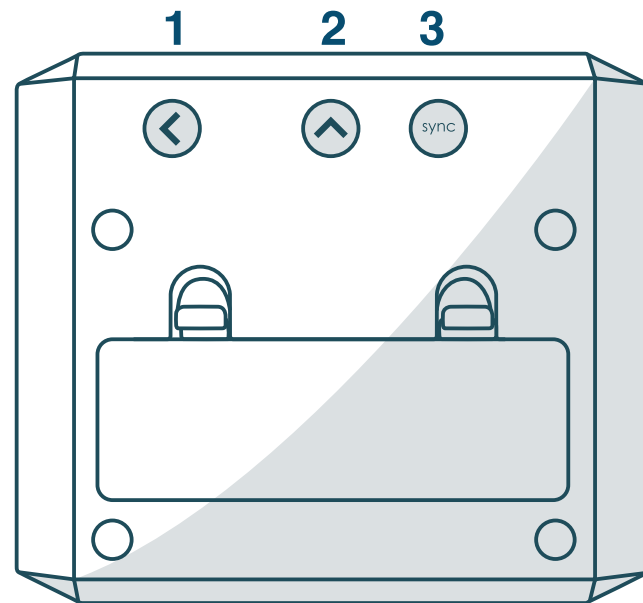
- 2** Front Power Button  
Turns left barrier on or off.
- 3** SYNC Button  
Syncs bOck Plus™.



### Power Light

-  Slowly Blinking Light  
The barrier is turned on.
-  Rapidly Blinking Light  
bOck Plus™ is low on battery.

**Quick Note:**  
The power light will remain solid for a few seconds after you turn on a barrier. Afterward, the light will slowly blink.

### Syncing bLOck Plus™

As with Bob's remote, you will need to sync bLOck Plus™ before using it for the first time.

#### Parts You'll Need:

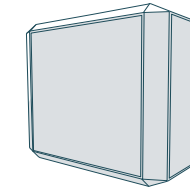

bLOck Plus™

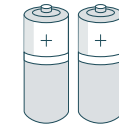

AA Batteries x4  
(not included)

#### Quick Tip:

 You can sync multiple bLOck accessories with Bob.

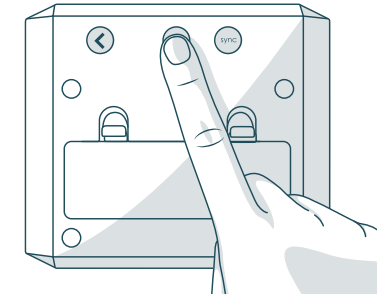
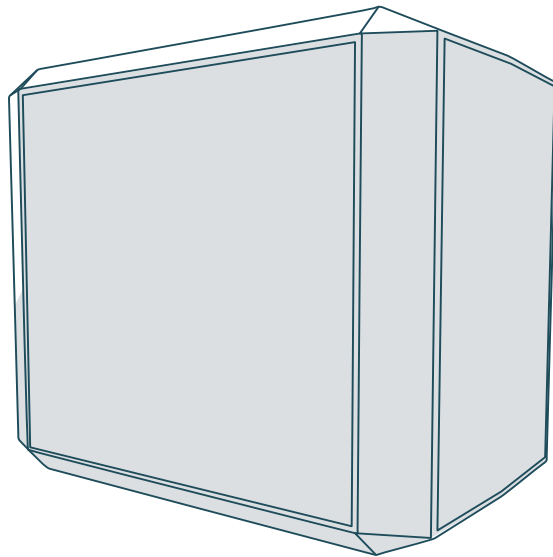

1. Press the  button. Wait for the red light on the front side of the block Plus™ to start slowly blinking before proceeding.

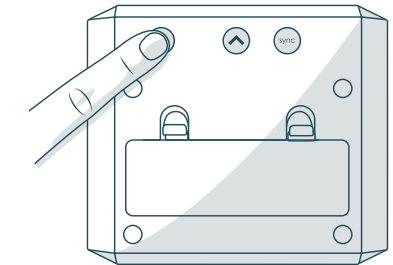

2. Press the  button. Wait for the red light on the left side of block Plus™ to start slowly blinking before proceeding.

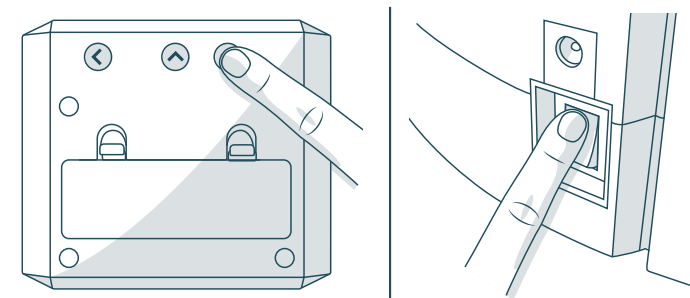

3. Hold down the SYNC button while at the same time flipping Bob's power switch ON.



Bob will chirp twice to let you know the sync was successful. If Bob does not chirp, repeat the process.

### Using bLOck Plus™

You can use bLOck Plus™ to create digital barriers that Bob will not cross. bLOck Plus™ emits 10 foot barriers from its front and left sides. You may use the front barrier or both barriers depending on your preference.

Make sure bLOck Plus™ is synced before proceeding.

#### Quick Tip:

- ⦿ The power lights will blink rapidly when bLOck Plus™ is low on battery. To conserve battery, turn bLOck Plus™ off when it is not in use.

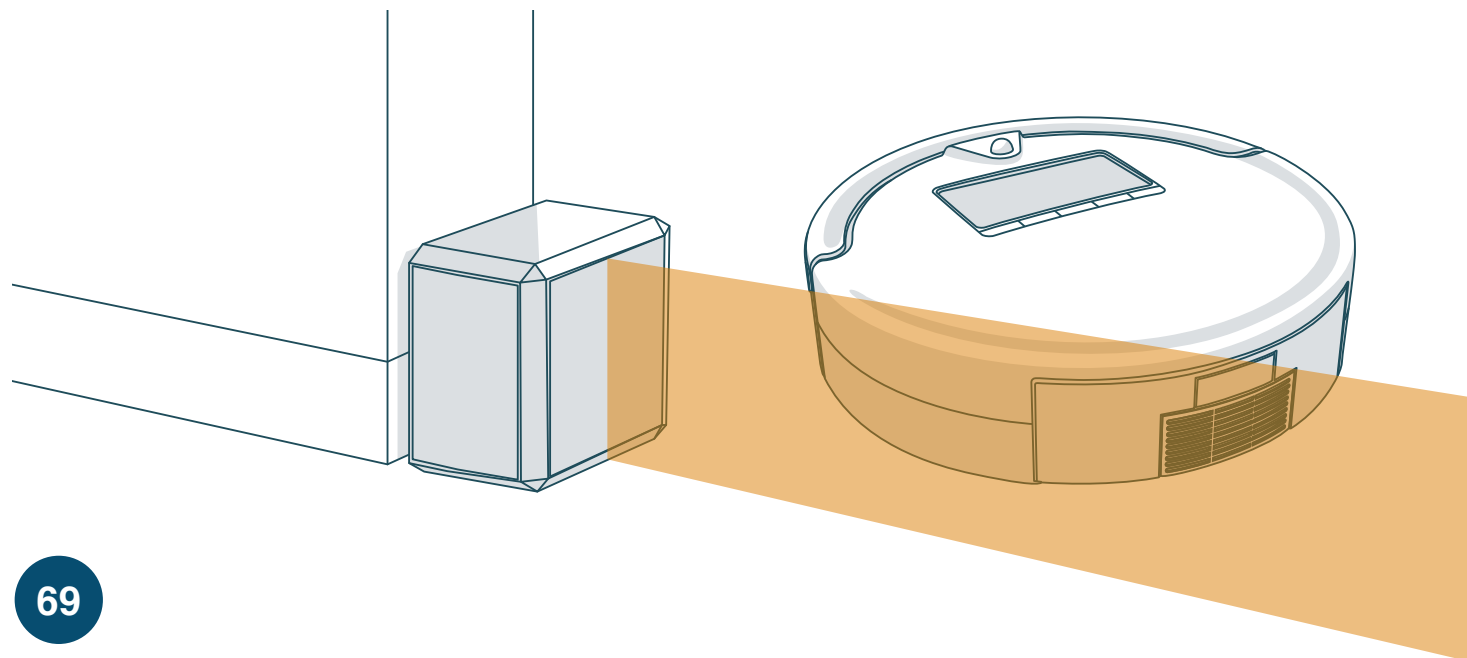

### Parts You'll Need:

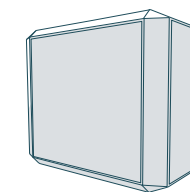

block Plus™

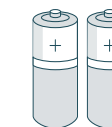

AA Batteries x4  
(not included)

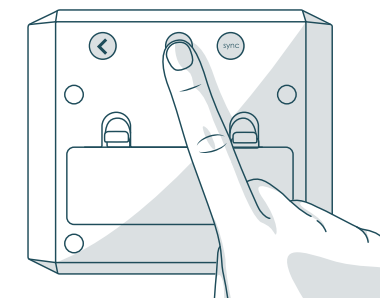

1. Press the **^** button. The power light on the front side will turn on.

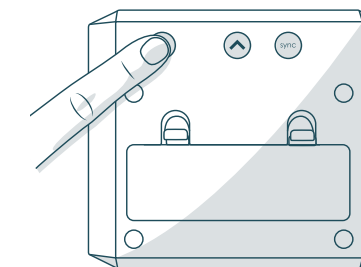

2. To use both barriers, press the **<** button next. The power light on the left side will turn on.

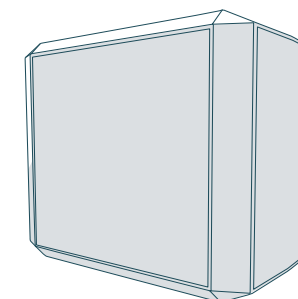

3. Position bLOck Plus™ so the area you do not want Bob to enter is blocked.

bLOck Plus™ will remain ON for 3 hours before turning itself OFF. To conserve battery, turn bLOck Plus™ off when it is not in use.



## Mop

Bob's mop attachment allows him to mop as he vacuums and sweeps.

### Quick Tip:

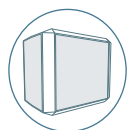

Do not let Bob climb onto carpet or rugs when he is mopping. You may use bLOck Plus™ to keep him away from carpet or rugs.

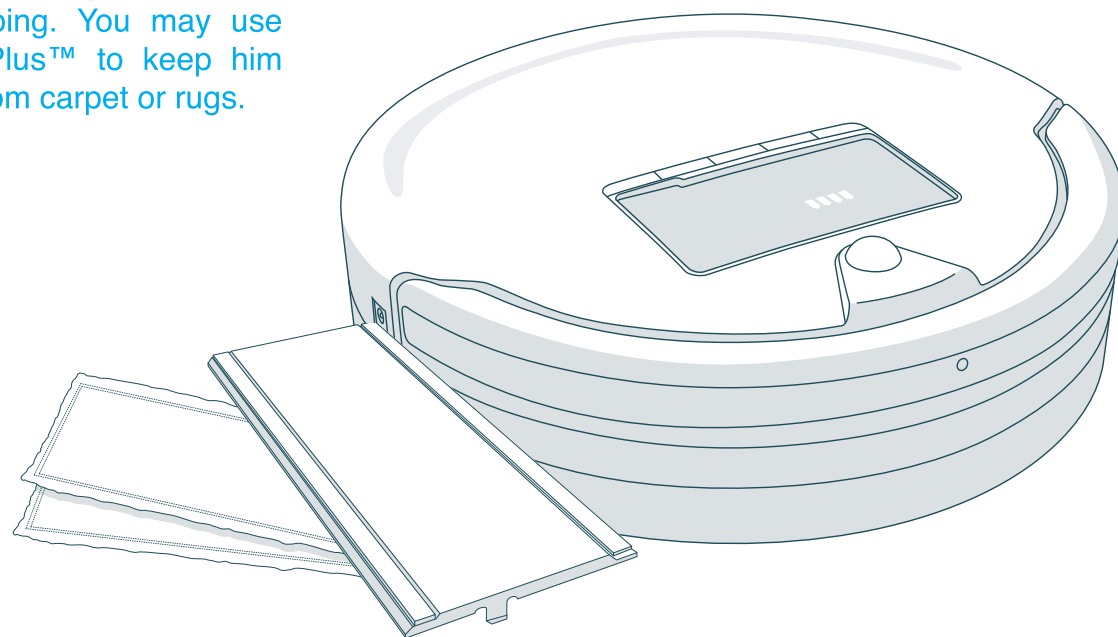

## Installing Bob's Mop Attachment

1. Dampen Bob's mopping cloth with water or cleaning solution before placing it on the mop attachment.
2. Align the prongs of the mop attachment between Bob's wheels and press down.

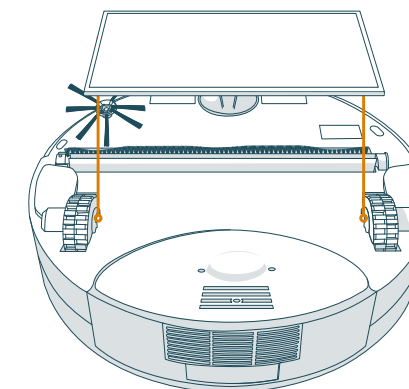

## Removing Bob's Mop Attachment

1. Detach the mop attachment by pulling up the edge that sits on top of Bob's dustbin.

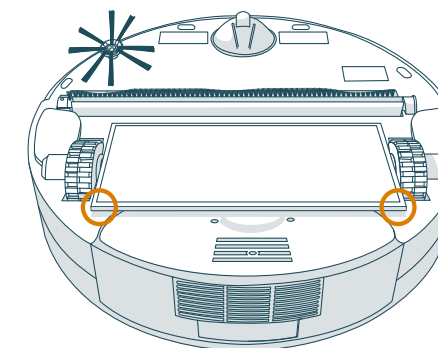

### Edge Sensors

If Bob repeatedly backs up or displays a trouble message while cleaning dark-colored carpet, then you'll need to deactivate the edge sensors. Make sure Bob is turned ON before proceeding.

#### Quick Tip:

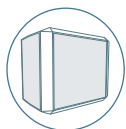

When the edge sensors are deactivated, Bob will be unable to detect stairs or sharp drops. You may use bLock Plus™ to keep him away from these obstacles.

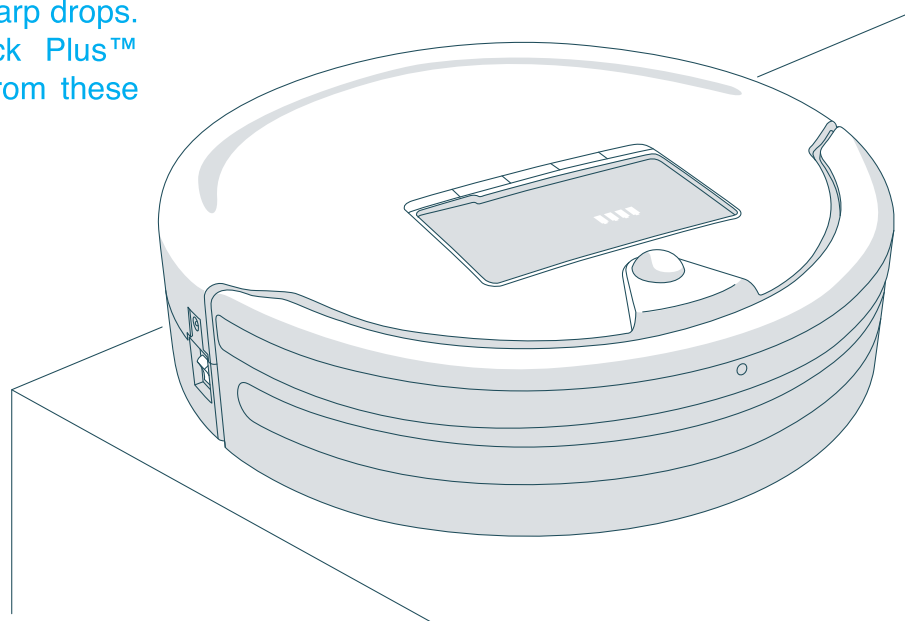

### Deactivating Bob's Edge Sensors

1. Hold down the CHECKUP button on Bob's cover. The 4 bars above the word "checkup" will start to flash on his screen.
2. Release the button when the bars stop flashing and remain lit.

The 4 bars above the word "checkup" remain lit on Bob's screen when his edge sensors are deactivated.

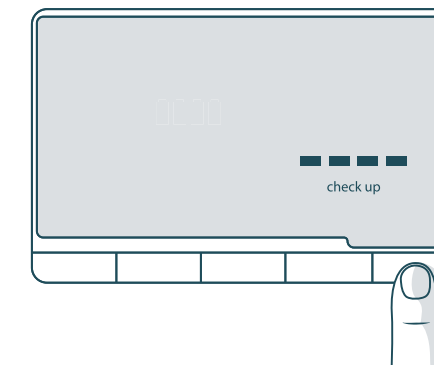

### Reactivating Bob's Edge Sensors

1. Hold down the CHECKUP button on Bob's cover. The 4 bars above the word "checkup" will start to flash on his screen.
2. Release the button when the bars stop flashing and are no longer lit.

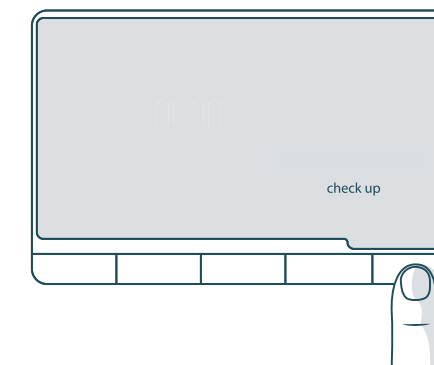

### Battery

On his default Deep Clean mode, Bob's battery lasts about 45 – 90 minutes per charge. Bob's battery has a 2-year warranty. Replacement batteries can be purchased at [www.bobsweep.com/shop](http://www.bobsweep.com/shop).

#### Parts You'll Need:



Phillips Head Screwdriver  
(not included)

#### Quick Tips:



To conserve Bob's battery, flip his power switch OFF and remove him from his charging station when he is not in use. Bob should not sit on his charging station for more than 5 days.



If you are not using Bob for an extended period of time, unplug his charging station, remove his battery, and store everything in a dry, room-temperature place away from direct sunlight.

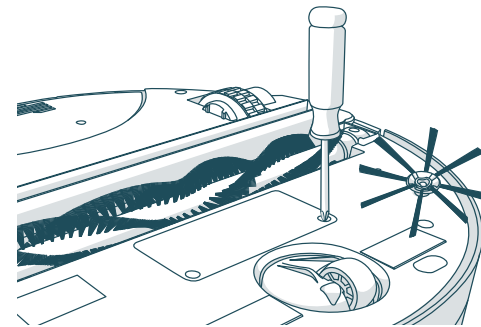
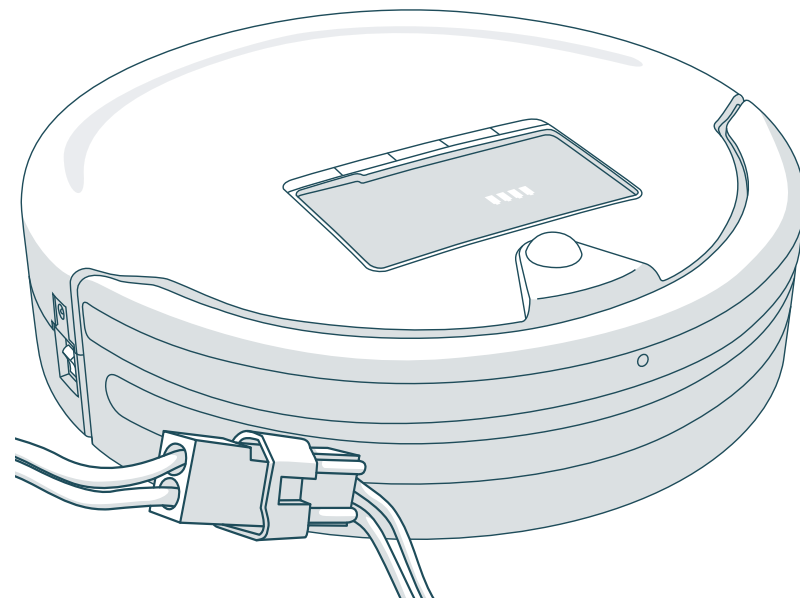

1. Remove the 2 screws on the battery cover using a Phillips head screwdriver.

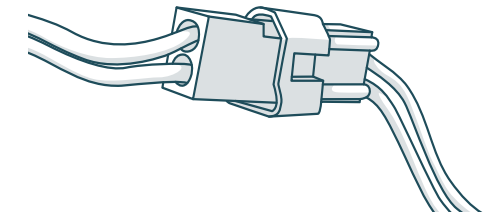

2. Disconnect the old battery by pulling the plug, not the wires. Plug in your new battery.

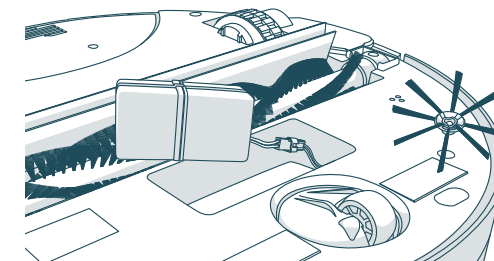

3. Slide the new battery into the compartment and replace the screws on the battery cover.

# Troubleshooting

If Bob is having a problem with one of his parts, a trouble message will light up on his screen saying, “Oops! I feel there’s something funny going on with my:”

- 80 Edge Sensors
- 82 Touch Sensors
- 84 Obstacle Sensors
- 86 Main Brush
- 88 Left Wheel
- 90 Right Wheel
- 92 Dustbin
- 94 Power System
- 96 (No Part Name) **Front Wheel**

If the problems persist, please contact our helpful support team at [support@bobsweep.com](mailto:support@bobsweep.com) or 1-888-549-8847. Our business hours are Monday – Friday, 9 a.m. – 5 p.m. Pacific Time.



Oops! I feel there's something funny going on with my: **Edge Sensors**

Parts You'll Need:

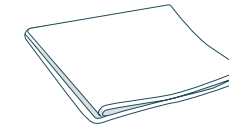

Cloth  
(not included)

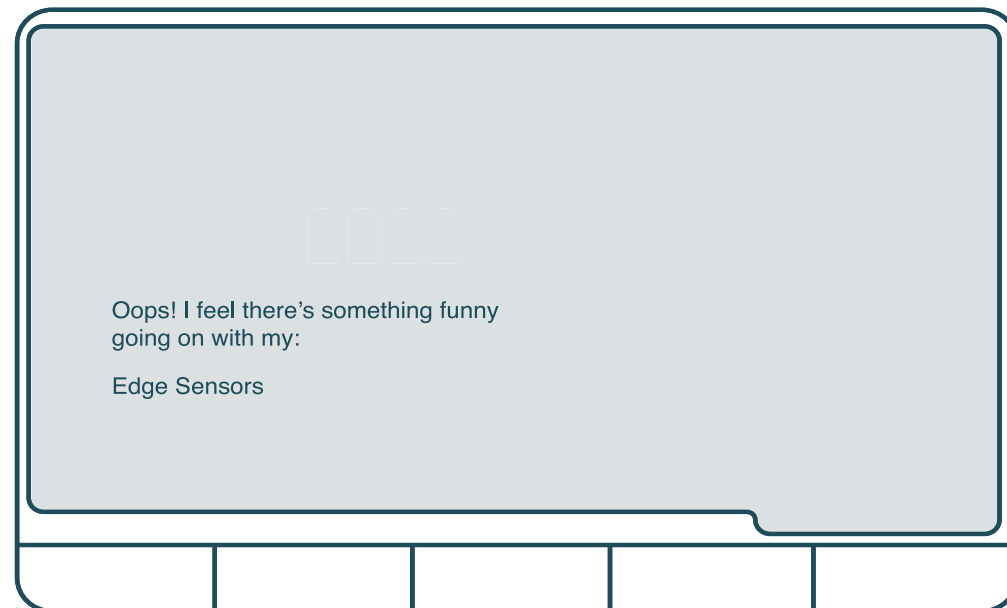

### What to do:

1. Wipe the edge sensors with a soft cloth slightly dampened with cold water or alcohol.
2. If problems persist, deactivate the edge sensors. Hold down the CHECKUP button on Bob's cover. The 4 bars above the word "checkup" will start to flash on his screen.

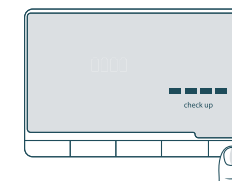
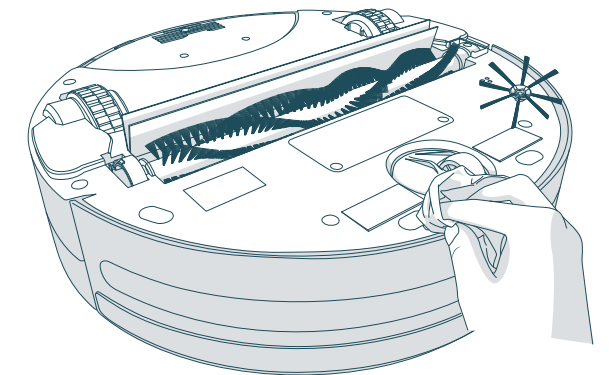

Release the button when the bars stop flashing and remain lit.

Oops! I feel there's something funny going on with my: **Touch Sensors**

Parts You'll Need:

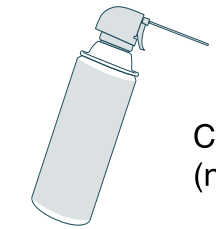

Compressed Air  
(not included)



### What to do:

1. Gently tap the bumper and use compressed air to clean underneath the bumper.
2. Press each end of the bumper until you hear a tiny "click." If the bumper is not clicking on its ends, the touch sensors may need to be replaced.

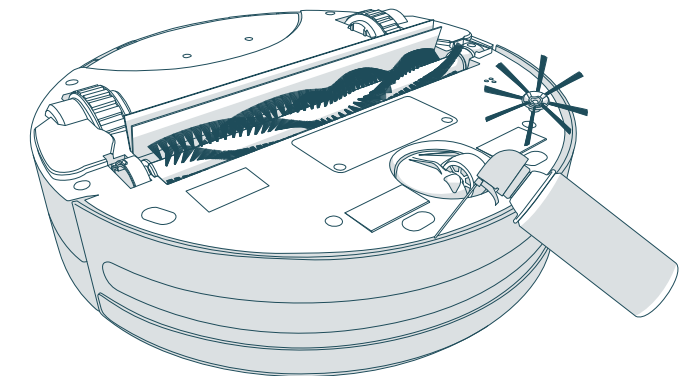

Oops! I feel there's something funny going on with my: **Obstacle Sensors**

Parts You'll Need:

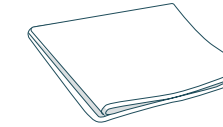

Cloth  
(not included)



Compressed Air  
(not included)

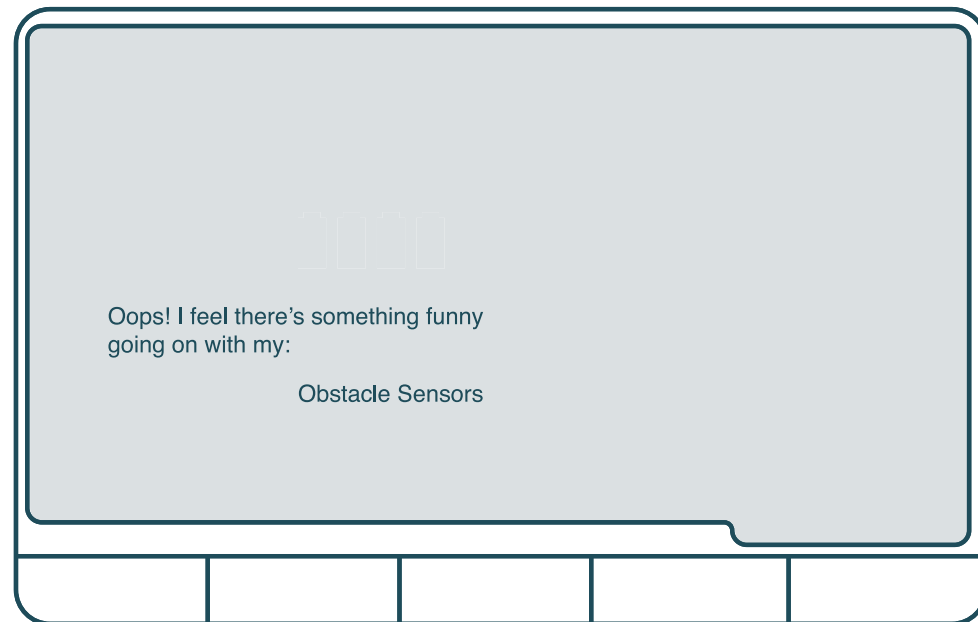

The obstacle sensors are also known as the wall sensors.

What to do:

1. Wipe the obstacle/wall sensors with a soft cloth slightly dampened with cold water or alcohol.
2. Gently tap the bumper and use compressed air to clean underneath the bumper.

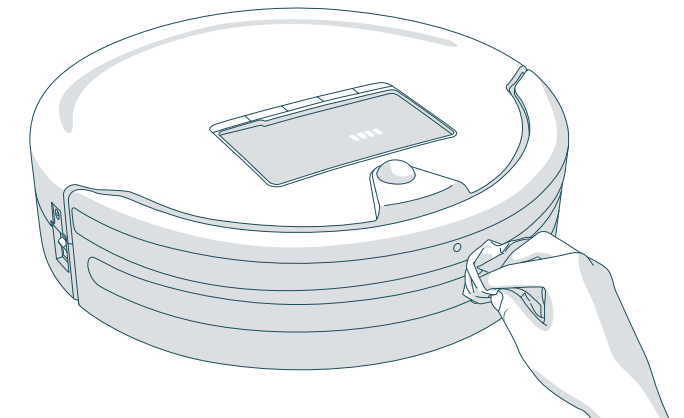

Oops! I feel there's something funny going on with my: **Main Brush**

### Parts You'll Need:



Flat Head  
Screwdriver



Cleaning Tool



### What to do:

1. Remove the screw on the main brush using a flat head screwdriver.
2. Clean the brush and the brush compartment from end to end using Bob's cleaning tool.
3. When done, replace the brush cap and insert the square end of the brush into the square notch inside Bob. Lastly, replace the screw.

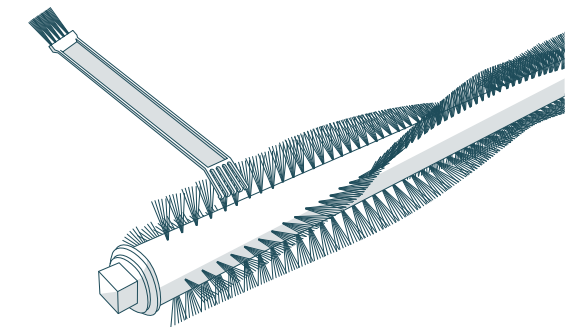

### Quick Tip:

 You may use scissors to cut away entanglements of hair, or tweezers to unclog the notches inside Bob.

Bob's main brush is not designed to clean shag carpet or rugs with long fibers. If you'd like Bob to clean shag carpet or long-fibered rugs, you may remove his main brush and allow him to vacuum without it.



Oops! I feel there's something funny going on with my: **Left Wheel**

### Parts You'll Need:



Cleaning Tool



Compressed Air  
(not included)



### What to do:

1. Use the cleaning tool or compressed air to remove debris jamming the left wheel.

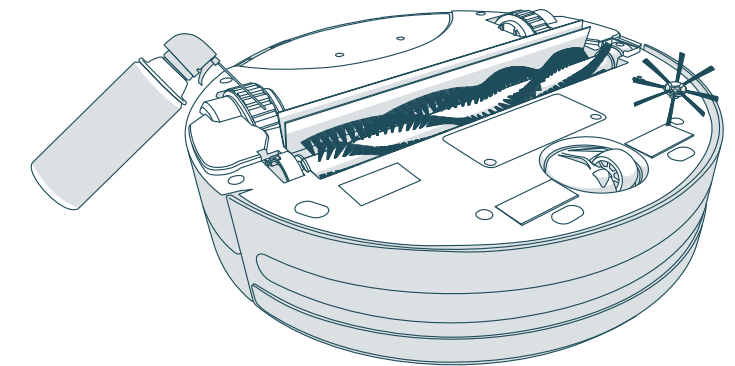

Oops! I feel there's something funny going on with my: **Right Wheel**

### Parts You'll Need:



Cleaning Tool

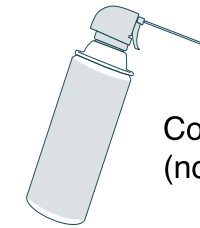

Compressed Air  
(not included)



### What to do:

1. Use the cleaning tool or compressed air to remove debris jamming the right wheel.

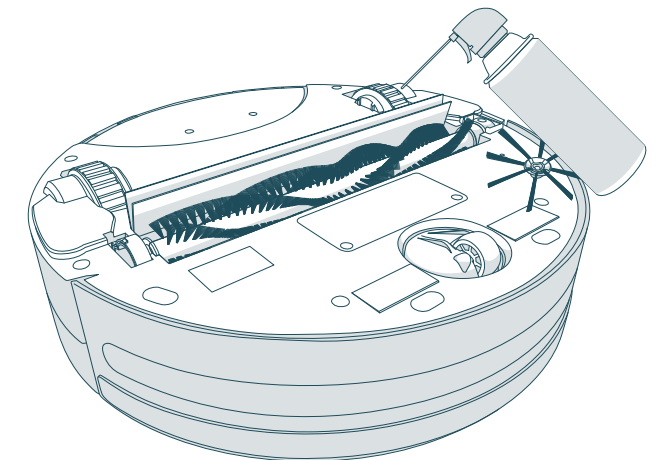

Oops! I feel there's something funny going on with my: **Dustbin**

Parts You'll Need:

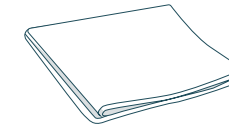

Cloth  
(not included)



### What to do:

1. Remove Bob's dustbin and empty it.
2. Gently wipe the two metal connectors on the bottom of the dustbin with a dry cloth. If the two metal connectors seem damaged, they may need to be replaced.
3. Lastly, clean the metal contact points inside Bob where the dustbin is inserted.

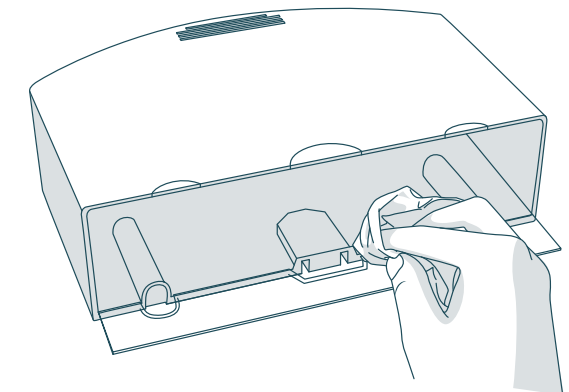

Oops! I feel there's something funny going on with my: **Power System**

### Parts You'll Need:

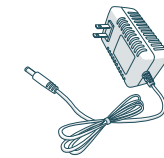

Charging Adapter

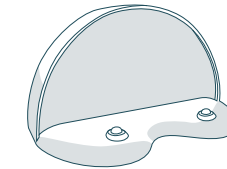

Charging Station



Phillips Head Screwdriver (not included)

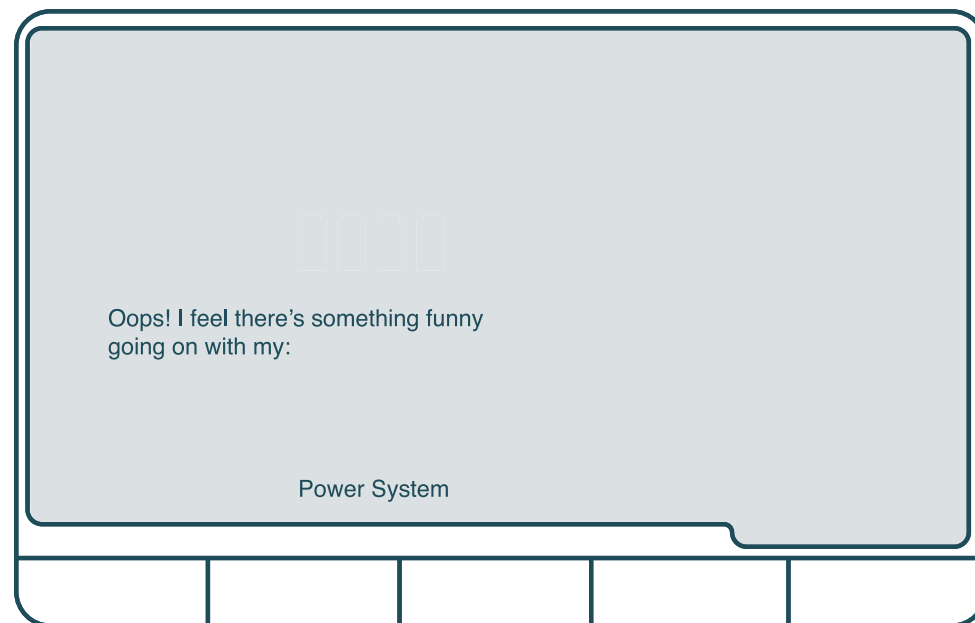

### What to do:

1. Place Bob on his charging station and allow him to fully charge.
2. If Bob is unable to charge on his station, charge him directly by plugging the charging adapter into the inlet above his power switch.
3. If Bob still has trouble charging, try reconnecting the battery. Flip Bob's power switch OFF.

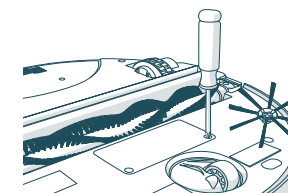
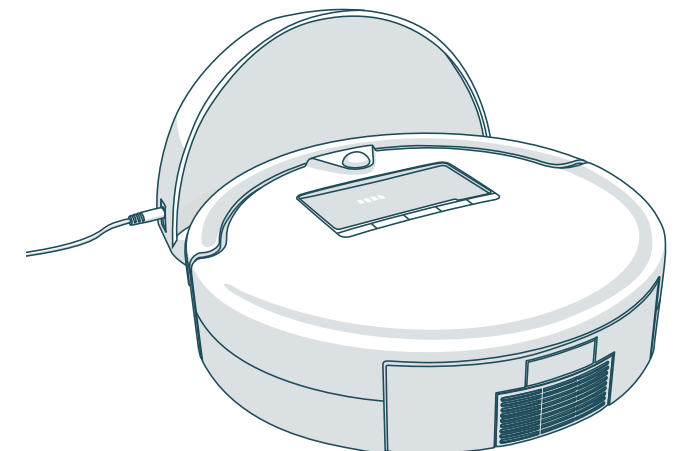

Open Bob's battery compartment using a Phillips head screwdriver.

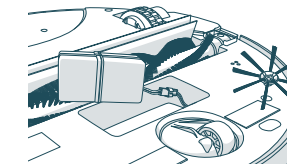

Unplug the battery, wait 30 seconds, and then reconnect the battery.

Oops! I feel there's something funny going on with my: **(No Part Name)**

Parts You'll Need:



Phillips Head Screwdriver  
(not included)



If Bob stops working and displays a trouble message with no part name, then his front wheel may be congested.

What to do:

1. Gently grip the wheel assembly and pull up. Use a screwdriver for leverage, if needed.
2. Open the front wheel assembly using a Phillips head screwdriver. Clean the assembly's inner parts.
3. Replace the wheel and make sure it spins freely inside the wheel assembly.

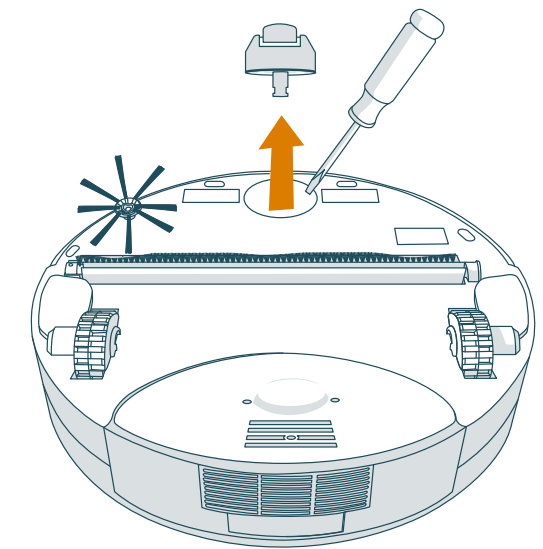

# Home Checkup Test

If Bob is not performing as well as he should, you can diagnose the problem with a simple home checkup test.

**100** Putting Bob in Checkup Mode

**102** Edge Sensors, Obstacle / Wall Sensors, Touch Sensors, and Charging Station

**104** bIOck Plus™, Display Screen, Brush / Suction Power, and UV Light / Wheels



### Putting Bob in Checkup Mode

While in checkup mode, the word “bObsweep” will flash on Bob’s screen.

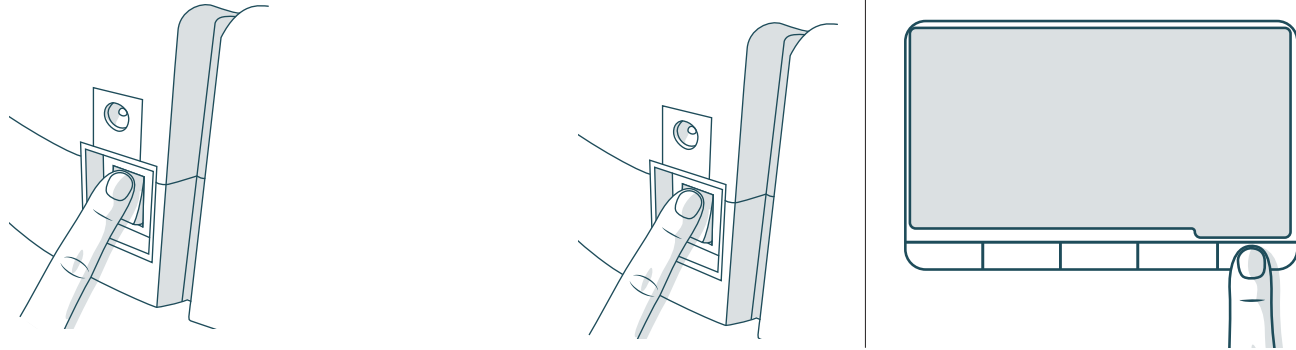

1. Flip Bob’s power switch OFF.

2. While holding down the CHECKUP button on Bob’s cover, flip Bob’s power switch ON.



Bob will chirp 3 times to let you know he is now in checkup mode. You may release the CHECKUP button. Do not press any additional buttons.

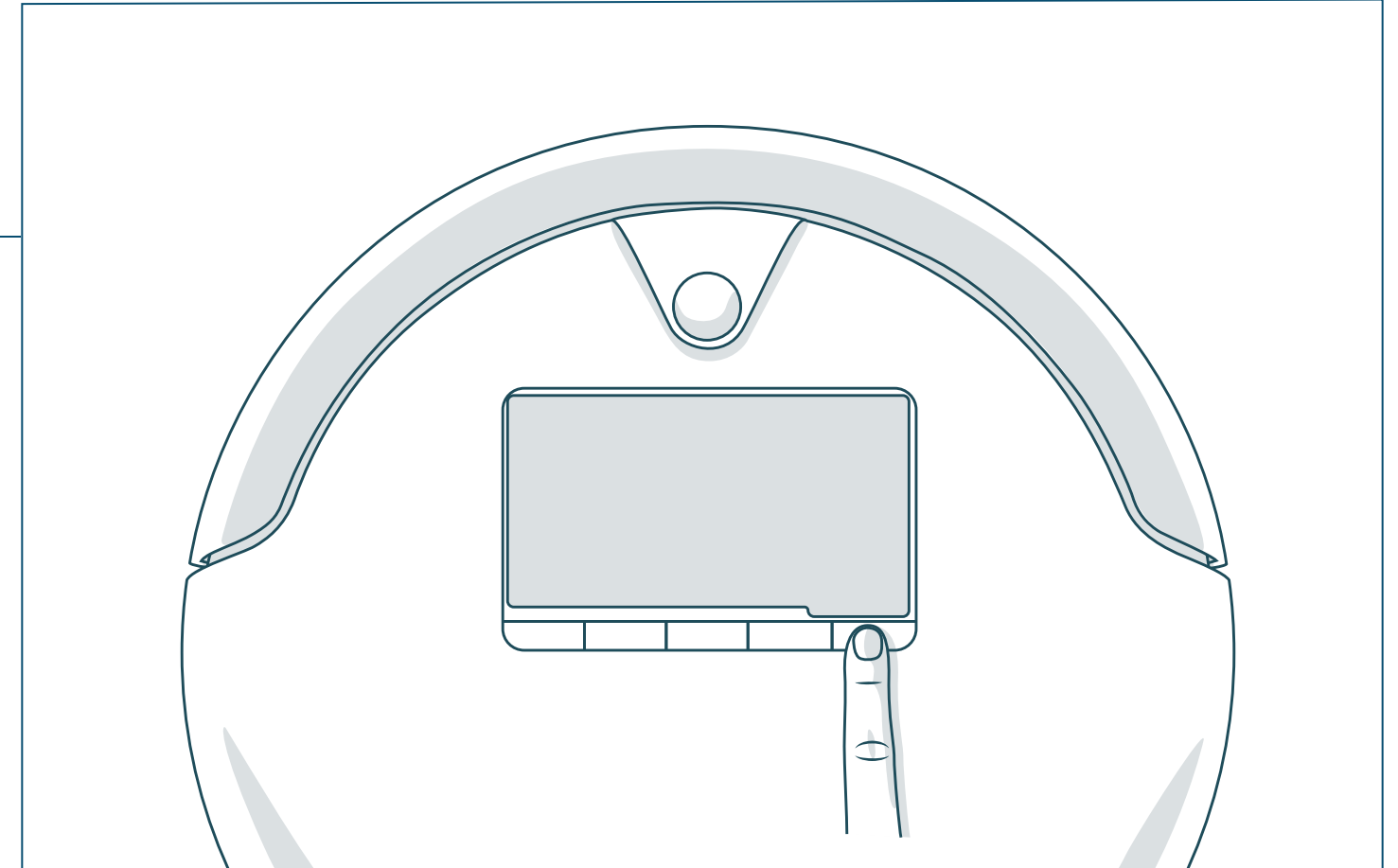

If Bob fails any part of the checkup test, he may need a replacement part. In this case, please contact our helpful support team at [support@bobsweep.com](mailto:support@bobsweep.com) or 1-888-549-8847. Our business hours are Monday – Friday, 9 a.m. – 5 p.m. Pacific Time.

### Step 1: Edge Sensors

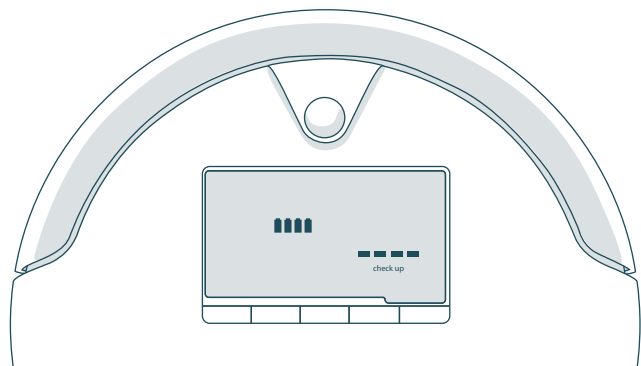

The 4 bars above the word “checkup” should be lit. Lift Bob about 6 inches (15 cm) off the ground and the 4 bars should turn off.

To skip ahead in the checkup test, follow the button sequence (bolded in blue).

To exit the checkup test, flip Bob’s power switch OFF and then ON.

### Step 2: Obstacle / Wall Sensors

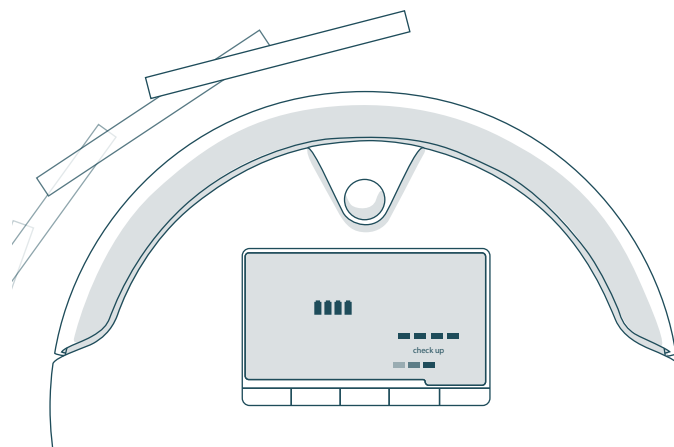

Drag a thick, flat, and light-colored surface around Bob’s bumper.

The 5 bars below the word “checkup” should light up one at a time as you move your surface from the left side of Bob’s bumper around to the right side.

The far right sensor is less sensitive than the others, so it may not respond the first few passes.

### Step 3: Touch Sensors

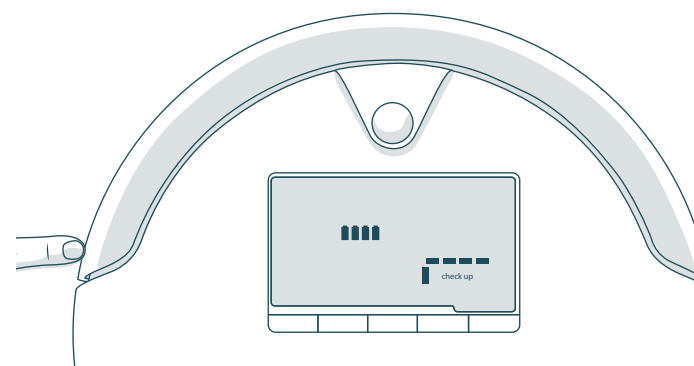

Press the left side of Bob’s bumper, and the bar to the left of the word “checkup” should light up; press the right side of the bumper, and the bar to the right of the word “checkup” should light up. Press the center of the bumper, and both bars on either side of the word “checkup” should light up at the same time.

When you release the bumper, the bars should turn off.

#### Quick Tip:

! The words “deep clean” and “touch up” represent the charging station’s sensors. If either one of them fails to light up on Bob’s screen, then there is likely something wrong with Bob’s station. The word “quick clean” represents the signal on Bob’s bumper. If it fails to light up, then Bob likely needs a new bumper transmitter.

### Step 4: Charging Station

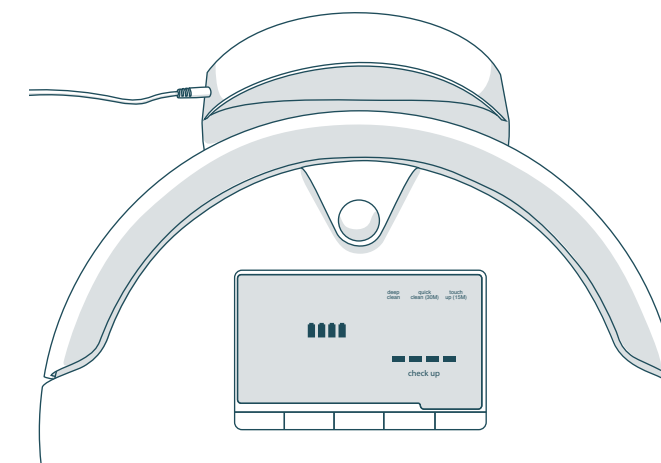

Press the **GO!** button on Bob’s cover.

The charging station must be synced and plugged in for this step.

Place Bob about 1 foot (30 cm) away from the charging station, with his front facing the red light on the station. Keep bOck Plus™ away from Bob so its signal does not interfere with the test. The words “deep clean,” “quick clean,” and “touch up” should be lit on Bob’s screen.



### Step 5: bIOck Plus™

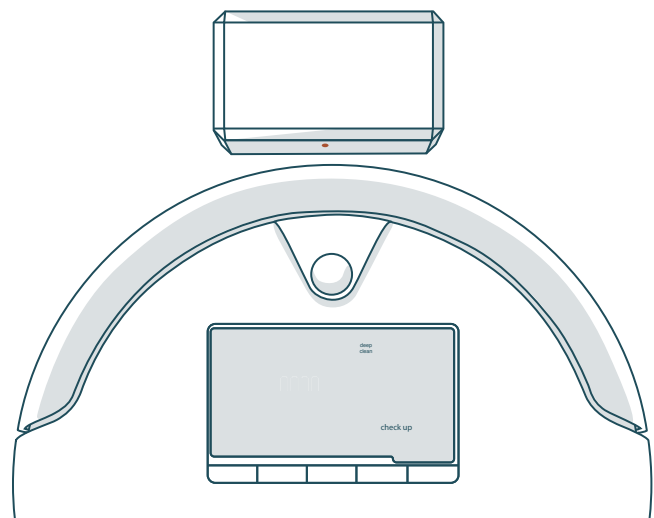

bIOck Plus™ must be synced for this step. Unplug the charging station so its signal does not interfere with this test.

Turn both barriers on. Place bIOck Plus™ so its front barrier directly faces Bob's front. The word "deep clean" should light up on Bob's screen. Now rotate bIOck Plus™ so its left barrier directly faces Bob's front. Again, "deep clean" should light up on his screen.

### Step 6: Display Screen

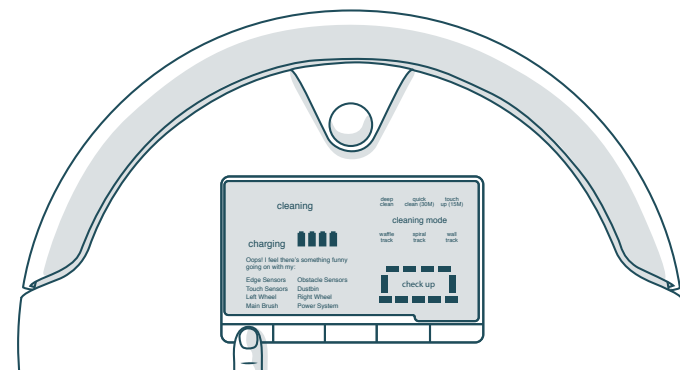

Press the **GO!** button on Bob's cover once more.

Each icon on Bob's screen should light up in a repeating rotation.

To exit the checkup test, flip Bob's power switch OFF and then ON.

### Step 7: Brush and Suction Power

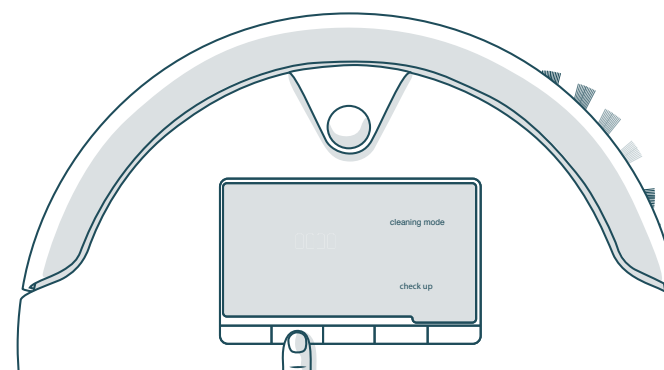

Press the **CLEANING MODE** button on Bob's cover. The main and side brushes should spin, and air should flow out of the dustbin.

If Bob's main brush is having difficulty moving, Bob will let you know by displaying that there is "something funny going on" with his main brush.

If Bob's vacuum motor is behaving oddly, or his dustbin has been removed, he will display that there is "something funny going on" with his dustbin.

### Step 8: UV Light and Wheels

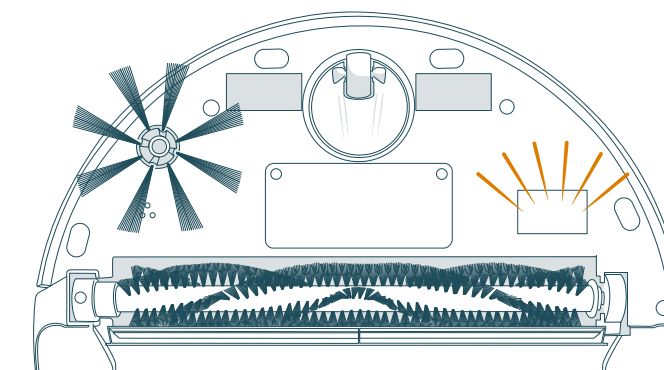

Lift Bob off the floor or place him on his side to keep him from running away!

Press the **CHARGE** button on Bob's cover.

Bob's wheels should drive forward and his UV lamp should light up. Do not look directly into the UV lamp. Press the **CHARGE** button once more. Bob's wheels should drive backwards and his UV lamp should turn off.

If Bob is having difficulty rotating his wheels, he will display that there is "something funny going on" with his wheels.

# FAQs

Still have questions that we haven't answered? Contact our helpful support team at [support@bobsweep.com](mailto:support@bobsweep.com) or 1-888-549-8847. Our business hours are Monday – Friday, 9 a.m. – 5 p.m. Pacific Time.



## My Bob won't turn on no matter what I do.

First, make sure Bob's power switch is turned ON. The power switch is located on Bob's left side. If Bob's power switch is turned ON and he is not responding to his cover buttons, then his battery has likely drained too low for him to operate. Place Bob on his charging station and allow him to fully charge.

## Why is Bob beeping?

Bob beeps periodically while in standby mode. You may mute his beeping by pressing the MUTE button on his cover or FullCommand™ remote. To conserve his battery, flip his power switch OFF when he is not in use.

Bob also beeps when he encounters a problem and needs assistance. In addition to beeping, he will display a trouble message. Consult the Troubleshooting section of this manual for solutions.

## How do I know that Bob is fully charged and ready to clean?

When Bob is charging, the battery bars on his display screen flash and the word "charging" is lit. When Bob is fully charged, the battery bars remain still and the word "charging" is no longer lit.

## Bob just stopped cleaning and his screen turned off. What do I do next?

Bob may be in standby mode. If this is the case, pressing any button on his cover or FullCommand™ remote should wake him. If this does not work, his battery is likely completely drained. Place Bob on his charging station and allow him to fully charge.

## How often should I empty the dustbin?

Depending on the size of the room and the amount of debris piled up, Bob may be able to perform up to 6 cleaning cycles before filling his dustbin. Simply remove the dustbin and check to see if emptying is necessary.

## Bob is having trouble finding his charging station.

First, sync the charging station. Start by flipping Bob's power switch OFF. Then, hold down the SYNC button on the back of the station and flip Bob's power switch ON. Bob will chirp twice to confirm the sync was successful. If after syncing the station Bob is still having trouble finding it, relocate the station to a more easily accessible location with more space around it. Make sure the station is against a wall on a flat, level surface.

## I am having problems removing Bob's brushes.

Unscrew the brushes and gently wiggle them while pulling up. Do not force the brushes out, as this can damage them. You may use scissors to cut away entanglements of hair, or tweezers to unclog the notches inside Bob. It is best to clean Bob's brushes about once a week to prevent buildup.

## How often should I clean Bob's brushes?

To maximize Bob's efficiency, it is best to clean his brushes about once a week. Remember to also clean the notches inside Bob that hold the brushes in place.

To watch Bob's how-to videos visit [www.bobsweep.com/pethair-plus-support](http://www.bobsweep.com/pethair-plus-support) or download the bObsweep App on your iOS or Android device.

## When should I use the different cleaning modes?

Deep Clean is Bob's default cleaning mode and gives him enough time to thoroughly cover a large area. On Deep Clean mode, Bob will clean for about 45 – 90 minutes before returning to his charging station when low on battery. If you would like Bob to clean a smaller area, you may use Quick Clean mode, which lasts 30 minutes, or Touch Up mode, which lasts 15 minutes. Waffle Track™ and Spiral Track™ are best used when cleaning small spills. On Waffle Track™, Bob travels in a grid pattern; on Spiral Track™, Bob travels in a gradually widening spiral. Select Wall Track™ to make Bob travel along the perimeter of your room.

## What is the best way to clean Bob's wheels?

Use compressed air to clear the wheels of debris, or wipe the wheels as they spin during the checkup test. For a more thorough clean, you may remove the wheels completely. See Bob's wheel repair guide on [www.bobsweep.com/pethair-plus-support](http://www.bobsweep.com/pethair-plus-support) for detailed instructions.

## Bob gets stuck under my furniture or travels over wires that tangle up his brush. How can I stop him from going into certain areas?

If Bob maneuvers under a piece of furniture and there is only one open entrance, he may need a few minutes to find his way out. If Bob does need help, he'll stop cleaning completely, beep, and display a trouble message.

If you would like Bob to avoid a certain area, such as an area with lots of wires, you may use bIOck Plus™ to create one or two digital barriers.

## Bob is telling me there's "something funny going on" with one of his parts. How can I fix this?

Bob's trouble messages identify the specific parts on Bob that need help. Consult the Troubleshooting section of this manual for solutions.

## Why does Bob start up when I did not tell him to clean?

Bob is either scheduled to clean or is on auto-resume mode.

First, make sure the current time and day is set correctly on Bob's FullCommand™ remote. Remember, Bob works on a 24-hour clock. If the current time and day is incorrect, then Bob's cleaning schedule will be out of sync.

Consult the Scheduling section of this manual for detailed instructions on how to reset Bob's cleaning schedule.

On auto-resume mode, Bob automatically begins cleaning after every recharge. When Bob is on auto-resume, he displays "bbgo" on his remote, below "Scheduled Cleanings." To disable auto-resume, press the SET CLEANING SCHEDULE button on Bob's remote. Then press STOP. The remote will reset to the last time saved.

Press SET CLEANING SCHEDULE again to save your settings.

## What is Bob's runtime? How long should Bob's battery last?

The exact runtime depends on the age of the battery and the type of surface Bob is cleaning; the younger the battery and the smoother the cleaning surface, the longer the runtime. The normal runtime range for Bob is 45 – 90 minutes.

Bob's battery comes with a 2-year warranty and should last for several years. To conserve Bob's battery, do not leave him on his charging station for more than 5 days. If you are not using Bob regularly, remove him from his station and flip his power switch OFF.

If problems persist, please contact our helpful support team at [support@bobsweep.com](mailto:support@bobsweep.com) or 1-888-549-8847.

Our business hours are Monday – Friday, 9 a.m. – 5 p.m. Pacific Time.

# End User Agreement



**IMPORTANT - READ BEFORE USING.** Do not use the robot (“Bobsweep”) accompanying this license agreement (“Agreement”) until you have carefully read and agreed to the following terms and conditions.

By using the Bobsweep, you agree to the terms of this End User License Agreement (“EULA”) and any amendment or addenda accompanying this Agreement. If you do not agree to the terms of this EULA, you may not use the Bobsweep. The Bobsweep contains an electronic and software interface that allows you to control or modify its behavior, and remotely monitor its sensors.

**THIS IS A LEGAL AGREEMENT. BY ACCESSING AND USING THE PRODUCT AND PRODUCT SOFTWARE, YOU ARE ACCEPTING AND AGREEING TO THIS EULA ON BEHALF OF YOURSELF OR THE ENTITY YOU REPRESENT IN CONNECTION WITH THE ACCESS. YOU REPRESENT AND WARRANT THAT YOU HAVE THE RIGHT, AUTHORITY, AND CAPACITY TO ACCEPT AND AGREE TO THIS EULA ON BEHALF OF YOURSELF OR THE ENTITY YOU REPRESENT. YOU REPRESENT THAT YOU ARE OF SUFFICIENT LEGAL AGE IN YOUR JURISDICTION OR RESIDENCE TO USE OR ACCESS THE PRODUCT SOFTWARE AND TO ENTER INTO THIS EULA. IF YOU DO NOT AGREE WITH ANY OF THE PROVISIONS OF THESE TERMS, YOU SHOULD CEASE USING THE PRODUCT AND PRODUCT SOFTWARE.**

#### Terms and Conditions

**LICENSE:** Subject to all of the terms of this Agreement, Bobsweep Inc. (“Bobsweep”) grants to you one (1) revocable, royalty-free, personal, non-exclusive, non-transferable, non-assignable, non-commercial intellectual property license to use the Bobsweep software contained on the Bobsweep (“Bobsweep Software”), including the protocol for communicating with the Bobsweep Software, and to use the Bobsweep.

**NONCOMMERCIAL LICENSE:** You may use the Bobsweep Software and the Bobsweep only for personal, non-commercial, educational, and research purposes. The Bobsweep Software and the Bobsweep may not be used for any other purpose, whether “for prot” or “not for prot.” Any work performed or produced using the Bobsweep, including any software that you create for your Bobsweep (“Your Software”), cannot be performed or produced for the benefit of other parties for a fee, compensation, or any other reimbursement or remuneration. A separate license is required for each additional use and/or individual user in all other cases. If you are an entity, Bobsweep grants you the right to designate one individual within your organization to have the sole right to use the Bobsweep Software and the Bobsweep in the manner provided above.

**RESTRICTIONS:** You agree not to: (i) use or copy the Bobsweep Software or the Bobsweep except as provided in this Agreement; (ii) rent or lease the Bobsweep Software or the Bobsweep to any third party; (iii) assign this Agreement or transfer the Bobsweep Software or the Bobsweep except as provided in this Agreement; (iv) modify, adapt, or translate the Bobsweep Software or the Bobsweep in whole or in part except as expressly provided in this Agreement; (v) reverse engineer, reverse compile, or disassemble the Bobsweep Software or the Bobsweep; or (vi) distribute, sublicense or transfer the source code form of Your Software and derivatives thereof to any third party except as provided in this Agreement.

**YOUR SOFTWARE :** Your Software is also subject to the following limitations: You (i) shall be solely responsible for any update or support obligation or other liability which may arise from your use or distribution, (ii) shall not make any statement that Your Software is “certified,” or that its performance is guaranteed, by Bobsweep, (iii) shall not use Bobsweep’s name or trademarks, (iv) shall prohibit disassembly and reverse engineering of the Bobsweep Software and the Bobsweep, (v) shall not publish reviews of Bobsweep products designated as beta without written permission from Bobsweep, and (vi) shall indemnify, hold harmless, and defend Bobsweep and its suppliers from and against any claims or lawsuits, including attorney’s fees, that arise or result from Your Software, including your use and your distribution.

**TITLE:** Title to the Bobsweep Software remains with Bobsweep or its suppliers. The Bobsweep Software is licensed, not sold. Except as expressly provided herein, Bobsweep does not grant any express or implied right to you under Bobsweep patents, copyrights, trademarks, or trade secret information. You will not remove any copyright or patent notice from the Bobsweep Software or the Bobsweep.

**ONE-TIME TRANSFER:** The initial user of the Bobsweep Software and the Bobsweep may make a one-time permanent transfer of this Agreement, the Bobsweep Software, and the Bobsweep to another end user, provided that the initial user retains no copies of the Bobsweep Software and the Bobsweep. This transfer must include the Bobsweep Software, the Bobsweep, and all of the materials accompanying the Bobsweep (including all component parts and printed materials, any upgrades, and this End User License Agreement document). The transfer may not be an indirect transfer, such as a consignment. Prior to the transfer, the end user receiving the Bobsweep Software and the Bobsweep must agree to all the terms of this Agreement.

**NO WARRANTY AND LIMITED REPLACEMENT: EXCEPT AS STATED IN THE LIMITED WARRANTY TO THE ORIGINAL PURCHASER, THE BOBSWEEP SOFTWARE AND THE BOBSWEEP ARE PROVIDED “AS IS” WITH NO WARRANTIES, EXPRESS OR IMPLIED, INCLUDING BUT NOT LIMITED TO ANY IMPLIED WARRANTY OF MERCHANTABILITY, FITNESS FOR A PARTICULAR PURPOSE, NON-INFRINGEMENT OF INTELLECTUAL PROPERTY RIGHTS, OR ANY WARRANTY OTHERWISE ARISING OUT OF ANY PROPOSAL, SPECIFICATION, OR SAMPLE. NO ORAL OR WRITTEN INFORMATION OR ADVICE GIVEN BY BOBSWEEP OR ITS AGENTS SHALL CREATE A WARRANTY.** If the Bobsweep Software or the Bobsweep is found to be defective in material or workmanship under normal use for a period of one (1) year from the date of receipt, Bobsweep’s entire liability and your exclusive remedy shall be the replacement of the Bobsweep Software or the Bobsweep. This offer is void if the defect results from accident, abuse, misapplication, or software that you developed for your Bobsweep. Any updates or supplements to the Bobsweep Software or the Bobsweep provided to you after the expiration of the one (1) year period are not covered by any warranty or condition, express, implied or statutory. **SOME JURISDICTIONS DO NOT ALLOW THE EXCLUSION OF IMPLIED WARRANTIES, SO THE ABOVE EXCLUSION MAY NOT APPLY TO YOU. LIMITATION OF LIABILITY: THE ABOVE REPLACEMENT PROVISION IS THE ONLY WARRANTY OF ANY KIND. BOBSWEEP OFFERS NO OTHER WARRANTY EITHER EXPRESS OR IMPLIED INCLUDING THOSE OF MERCHANTABILITY, NON INFRINGEMENT OF THIRD- PARTY INTELLECTUAL PROPERTY OR FITNESS FOR A PARTICULAR PURPOSE. NEITHER BOBSWEEP NOR ITS SUPPLIERS SHALL BE LIABLE FOR ANY DAMAGES WHATSOEVER (INCLUDING, WITHOUT LIMITATION, VICARIOUS LIABILITY, CONSEQUENTIAL DAMAGES, INCIDENTAL DAMAGES, DAMAGES FOR LOSS OF BUSINESS PROFITS, BUSINESS INTERRUPTION, LOSS OF BUSINESS INFORMATION, OR OTHER LOSS) ARISING OUT OF THE USE OF OR INABILITY TO USE THE BOBSWEEP SOFTWARE, THE BOBSWEEP, OR SOFTWARE THAT YOU DEVELOPED FOR YOUR BOBSWEEP, EVEN IF BOBSWEEP HAS BEEN ADVISED OF THE POSSIBILITY OF SUCH DAMAGES. BECAUSE SOME JURISDICTIONS PROHIBIT THE EXCLUSION OR LIMITATION OF LIABILITY FOR CONSEQUENTIAL OR INCIDENTAL DAMAGES, THE ABOVE LIMITATION MAY NOT APPLY TO YOU UNAUTHORIZED USE: THE BOBSWEEP SOFTWARE AND THE BOBSWEEP ARE NOT DESIGNED, INTENDED, OR AUTHORIZED FOR USE IN ANY AERONAUTICAL, NUCLEAR, MEDICAL, LIFE SAVING OR LIFE SUSTAINING SYSTEMS, OR FOR ANY OTHER APPLICATION IN WHICH THE USE OF THE BOBSWEEP SOFTWARE OR THE BOBSWEEP COULD CREATE A SITUATION WHERE PERSONAL INJURY OR DEATH MAY OCCUR.** Should you use the Bobsweep Software or Bobsweep for any such unintended or unauthorized use, you shall indemnify and hold harmless Bobsweep and its officers, subsidiaries and affiliates against all claims, costs, damages, and expenses, and reasonable attorney fees arising out of, directly or indirectly, any claim of product liability, personal injury or death associated with such unintended or unauthorized use, even if such claim alleges that Bobsweep was negligent regarding the design or manufacture of the Bobsweep Software, the Bobsweep, or any part or portion thereof.

**USER SUBMISSIONS:** You agree that any material, information or other communication, including all data, images, sounds, text, and other things embodied therein, that you transmit or post to a Bobsweep website or provide to Bobsweep (“Communications”) will be considered non-confidential. Bobsweep will have no confidentiality obligations with respect to the Communications. You agree that Bobsweep and its designees will be free to copy, modify, create derivative works, publicly display, disclose, distribute, license and sublicense through multiple tiers of distribution and licensees, incorporate and otherwise use the Communications, including derivative works thereof, for any and all commercial or non-commercial purposes without the payment of any royalty to you, and that such license will survive the termination of this Agreement.

**TERMINATION:** This Agreement becomes effective on the date you accept this Agreement and will continue until terminated as provided for in this Agreement. You may terminate this Agreement voluntarily at any time. Bobsweep may terminate this Agreement at any time if you are in breach of any of its terms and conditions, and may refuse to license the Bobsweep Software or the Bobsweep to you after termination. Upon termination by either party, you will immediately return to Bobsweep or destroy the Bobsweep Software and the Bobsweep and all your copies thereof. Articles 5 and 7 through 17 of this Agreement shall survive such termination. **U.S. GOVERNMENT RESTRICTED RIGHTS:** The Bobsweep Software and the Bobsweep are provided with “RESTRICTED RIGHTS.” Use, duplication or disclosure by the Government is subject to restrictions set forth in FAR52.227-14 and DFAR252.227-7013 et seq. or its successor. Use of the Bobsweep Software or the Bobsweep by the Government constitutes acknowledgment of Bobsweep’s rights in them.

**NO EXPORT:** You may not export the Bobsweep Software or the Bobsweep in violation of applicable export laws.

**INTERPRETATION PROVISION:** The provisions of this Agreement are severable. If any provision of this Agreement is held to be unenforceable, such provision shall be reformed only to the extent necessary to make it enforceable. Any law or regulation which provides that the language of a contract shall be construed against the drafter shall not apply to this Agreement.

**INTEGRATION:** This Agreement represents the complete agreement concerning the subject matter hereof, and any and all understandings, conversations and communications, proposals, and counterproposals, oral and written (including any draft of this Agreement) are merged into and superseded by this Agreement and shall be of no force or effect, except as expressly provided herein. No such understandings, conversations, communications, proposals, counterproposals or drafts shall be referred to in any proceeding concerning this Agreement. Further, no understanding contained in this Agreement shall be modified, altered or amended, except by a writing signed by the party against whom enforcement is sought.

**ARBITRATION:** All disputes relating to this Agreement (excepting any dispute relating to intellectual property rights) shall be subject to final and binding arbitration, with the losing party paying all costs of arbitration. Any arbitration relating to this Agreement shall be held in California, under the auspices of an arbiter selected by Bobsweep. Any litigation relating to this Agreement shall be subject to exclusive venue and jurisdiction in the federal and state courts of California, with the losing party responsible for costs, including without limitation, court costs and reasonable attorneys fees and expenses.

**APPLICABLE LAWS:** Any claim arising under or relating to this Agreement shall be governed by the internal substantive laws of the Commonwealth of California, without regard to its principles of conflict of laws. The application of the United Nations Convention on Contracts for the International Sale of Goods is expressly excluded.

bObsweep

® and © bObsweep Inc. All rights reserved.