

Mecabot User Manual

Authors: Zijie Li, Reilly Smithers, Tara Hercz & Wayne Liu

October 31, 2024

Version # 20241031

TABLE OF CONTENTS

1. Key Components
2. Product Specifications
3. Introduction to ROS Controllers
4. Sensing System: LiDAR & Depth Camera
5. STM32 Board (Motor Control, Power Management & IMU)
6. Steering & Driving System
7. Power Management
8. Tele-operation
9. ROS 2 Quick Start
10. Pre-installed ROS 2 Humble Packages

Summary

Mecabot is an educational and research robot based on ROS (Robot Operating System) for robotic researchers, educators, students and developers.

Mecabot is equipped with builtin ROS Controller, LiDAR, Depth Camera, STM32 Motor/Power/IMU Controller and metal chassis with omnidirectional mecanum wheels.

Mecabot is ideal for ROS beginners with affordable price, compact design and ready-to-go package. Mecabot is also a solid Autonomous Mobile Robot (AMR) platform for robotic education and research projects.

Mecabot comes with four models:

Mecabot 2 - Suitable for ROS beginners and low budget projects.

Mecabot Pro - An ideal Autonomous Mobile Robot (AMR) platform for robotic education, R&D projects and rapid prototyping.

Mecabot Plus - An ideal Autonomous Mobile Robot (AMR) platform for indoor service robot applications. This category is serious enough to be considered for industrial and commercial development.

Mecabot X - An ideal Autonomous Mobile Robot (AMR) platform for indoor service robot applications with full metallic enclosure.

Mecabot comes with popular ROS controllers such as:

Jetson - Orin Nano

Jetson - Orin NX

ROBOWORKS

1. Key Components

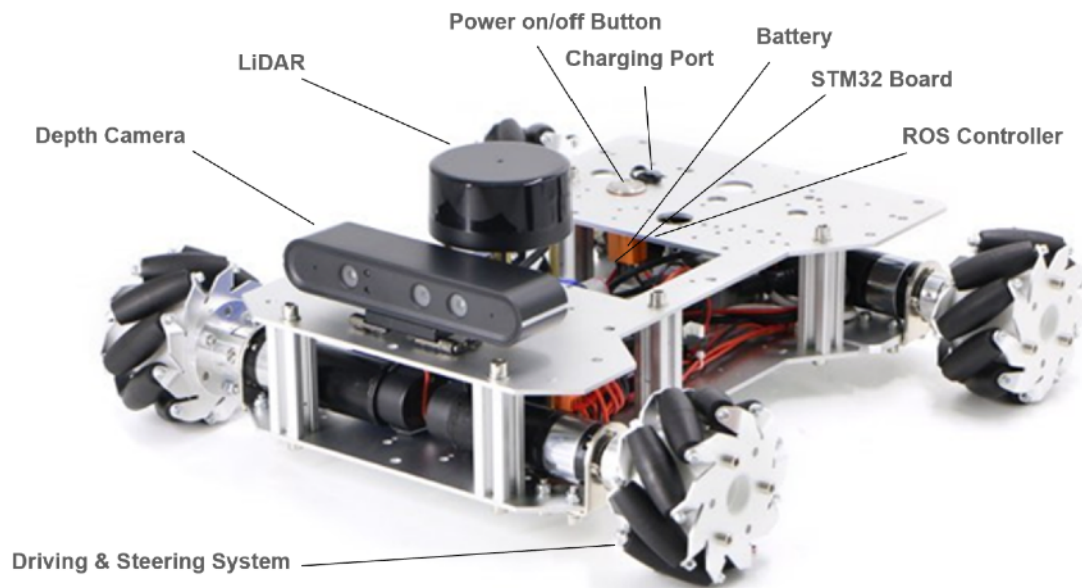

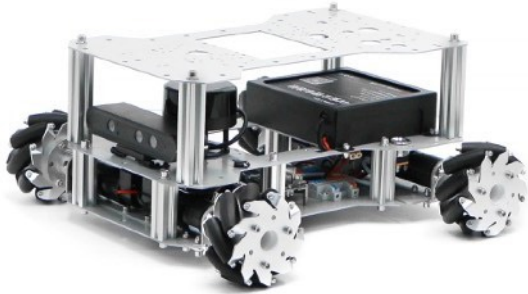
Variation	Image
Mecabot 2	

Mecabot Pro







Mecabot Plus



Mecabot X



2. Product Specifications

Product Matrix	Mecabot 2	Mecabot Pro	Mecabot Plus	Mecabot X
Photo				
Independent Suspension	No	Yes	Yes	Yes
Dimension	413x405x191 mm	541x581x225 mm	636x554x248 mm	630x581x203 mm
Weight	6.1kg	10.8kg	19kg	20.5kg
Payload	15kg	20kg	60kg	60kg
Wheel Size (Diameter)	100mm	152mm		
Max Speed	1.2m/s	1.83m/s	1.39m/s	
Power Supply	24v 6100 mAh LFP battery + 3A current smart charger			
Battery Life	8 hours without loading 6.5 hours with 3kg loading		4 hours without loading 3 hours with 3kg loading	
Motor and Reduction Ratio	MD36N 35W DC Brushed Motor 1:27 Reduction Ratio		MD60 100W DC Brushed Motor 1:18 Reduction Ratio	
Encoder	500-line giant magnetoresistance effect AB phase high-precision encoder			
I/O Interface	CAN, Serial Ports, USB, HDMI			
Remote Control	iOS/Android Apps (default) PS2, Model Aircraft Remote Control (optional and payable)			

3. Introduction of ROS Controllers

There are 2 types of ROS Controllers available for use with the Mecabot based on Nvidia Jetson platform. Jetson Orin Nano is ideal for education and research. Jetson Orin NX is used more often in prototyping and commercial applications.

The following table illustrates the main technical differences between the various controllers available from Roboworks. Both boards allow high level computation and are suited towards advanced robotic applications such as computer vision, deep learning and motion planning.

Jetson Orin NX series		Jetson Orin Nano series		
Jetson Orin NX 16GB	Jetson Orin NX 8GB	Jetson Orin Nano Developer Kit	Jetson Orin Nano 8GB	Jetson Orin Nano 4GB
100 TOPS	70 TOPS	40 TOPS		20 TOPS
1024-core NVIDIA Ampere architecture GPU with 32 Tensor Cores		1024-core NVIDIA Ampere architecture GPU with 32 Tensor Cores		512-core NVIDIA Ampere architecture GPU with 16 Tensor Cores
918MHz	765MHz	625MHz		

4. Sensing System: LiDAR & Depth Camera

A Leishen LSLiDAR is installed on all Mecabot variations with either the N10 or M10 model being used. These LiDAR's offer a 360 degree scanning range and surroundings perception and boast a compact and light design. They have a high Signal Noise Ratio and excellent detection performance on high/low reflectivity objects and perform well in strong light conditions. They have a detection range of 30 metres and a scan frequency of 12Hz. This LiDAR integrates seamlessly into the Mecabots, ensuring all mapping and navigational uses can be easily achieved in your project.

The below table summarizes the technical specifications of the LSLIDARs:

LS LIDAR	N10	M10	C16 (3D)
Detection Range	25m	30m	70/120/150 m
Scan Frequency	10Hz	12Hz	5/10/20Hz
Samples Frequency	4,500Hz	20,000Hz	240,000Hz
Output Contents	Angular, Distant and Light Intensity Data	Angular and Distant Data	Angular, Distant, Time Stamp and Light Intensity Data
Angular Resolution	0,8	0,22	1~2
Interface Type	Serial Port	Ethernet Port	Ethernet Port

Additionally, all Mecabots are equipped with an Orbbec Astra Depth Camera, which is an RGBD camera. This camera is optimized for a range of uses including gesture control, skeleton tracking, 3D scanning and point cloud development. The following table summarizes the technical features of the depth camera.

Orbbec Astra Depth Camera	Specs
Depth Resolution	640x480
RGB Resolution	640x480
RGB Sensing Angle	63.1x49.4 degree
Depth Sensing Angle	58.4x45.5 degree
Monocular/Binocular Structural Light	Monocular Structural Light + Monocular RGB
Depth Frame per Second	640x480@30fps
RGB Frame per Second	640x480@30fps
Depth Range	0.6~4m
Data Transfer Interface	USB2.0 or above

5. STM32 Board (Motor Control, Power Management & IMU)

The STM32F103RC Board is the micro-controller used in all Mecabots. It has a high performance ARM Cortex -M3 32-bit RISC core operating at a 72MHz frequency along with high-speed embedded memories. It operates in -40°C to +105°C temperature range, suiting all robotic applications in worldwide climates. There are power-saving modes which allow the design of low-power applications. Some of the applications of this micro-controller include: motor drives, application control, robotic application, medical and handheld equipment, PC and gaming peripherals, GPS platforms, industrial applications, alarm system video intercom and scanners.

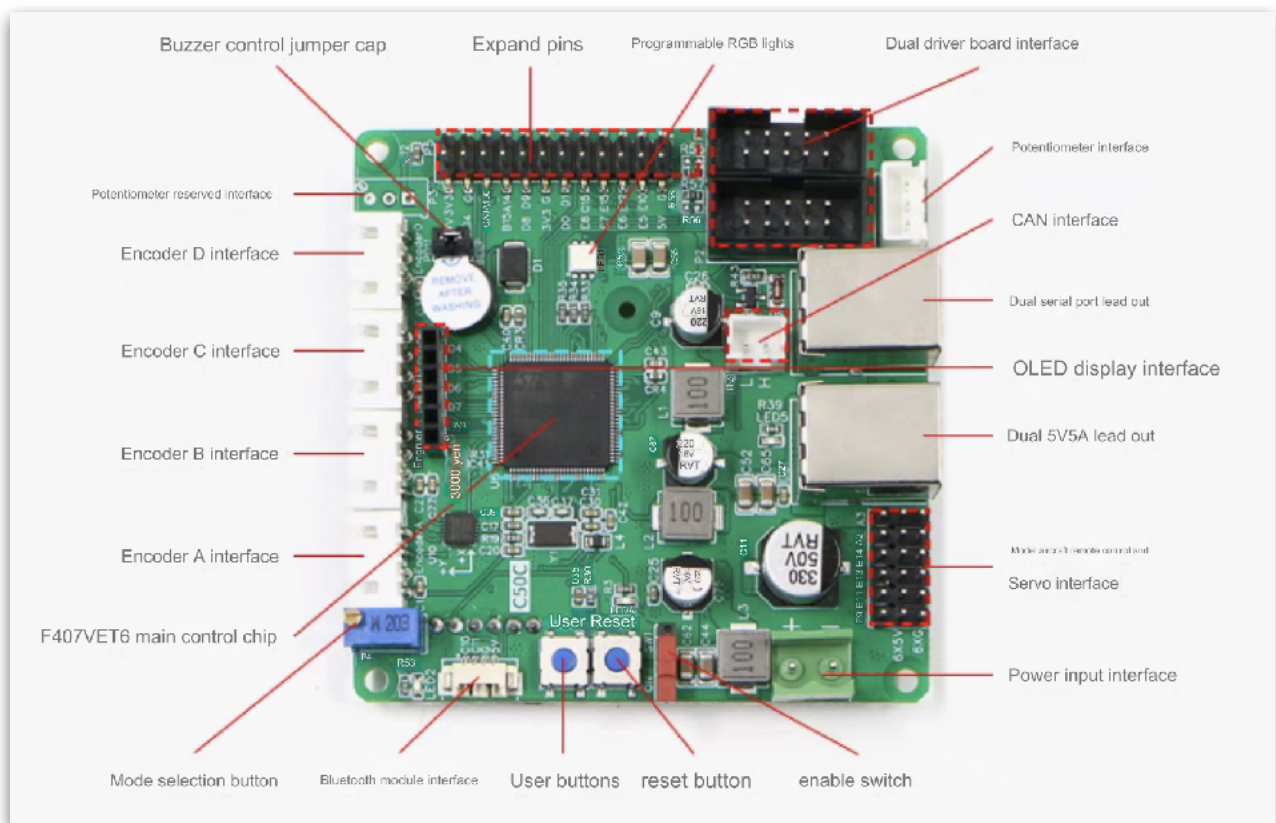

STM32F103RC	Features
Core	ARM32-bit Cortex –M3 CPU Max speed of 72 MHz
Memories	512 KB of Flash memory 64kB of SRAM
Clock, Reset and Supply Management	2.0 to 3.6 V application supply and I/Os
Power	Sleep, Stop and Standby modes V_{BAT} supply for RTC and backup registers
DMA	12-channel DMA controller
Debug Mode	SWD and JTAG interfaces Cortex-M3 Embedded Trace Macrocell
I/O ports	51 I/O ports (mappable on 16 external interrupt vectors and 5V tolerant)
Timers	4x16-bit timers 2 x 16-bit motor control PWM timers (with emergency stop) 2 x watchdog timers (independent and Window) SysTick timer (24-bit downcounter) 2 x 16-bit basic timers to drive the DAC
Communication Interface	USB 2.0 full speed interface SDIO interface CAN interface (2.0B Active)

6. Steering & Driving System

The Steering and Driving system is integrated with the design and build of the Mecabot. Depending on the model purchased it will be either a 2 wheel or 4 wheel drive, with both options being suitable to a variety of research and development purposes. The wheels on all Mecabots are omnidirectional mecanum wheels with all varieties besides the standard Mecabot inclusive of an independent suspension system. The Mecabot family of robots are ideal for a wide variety of research and commercial applications making it the perfect robot for your next project.

Mecabot 2 Design Diagram:

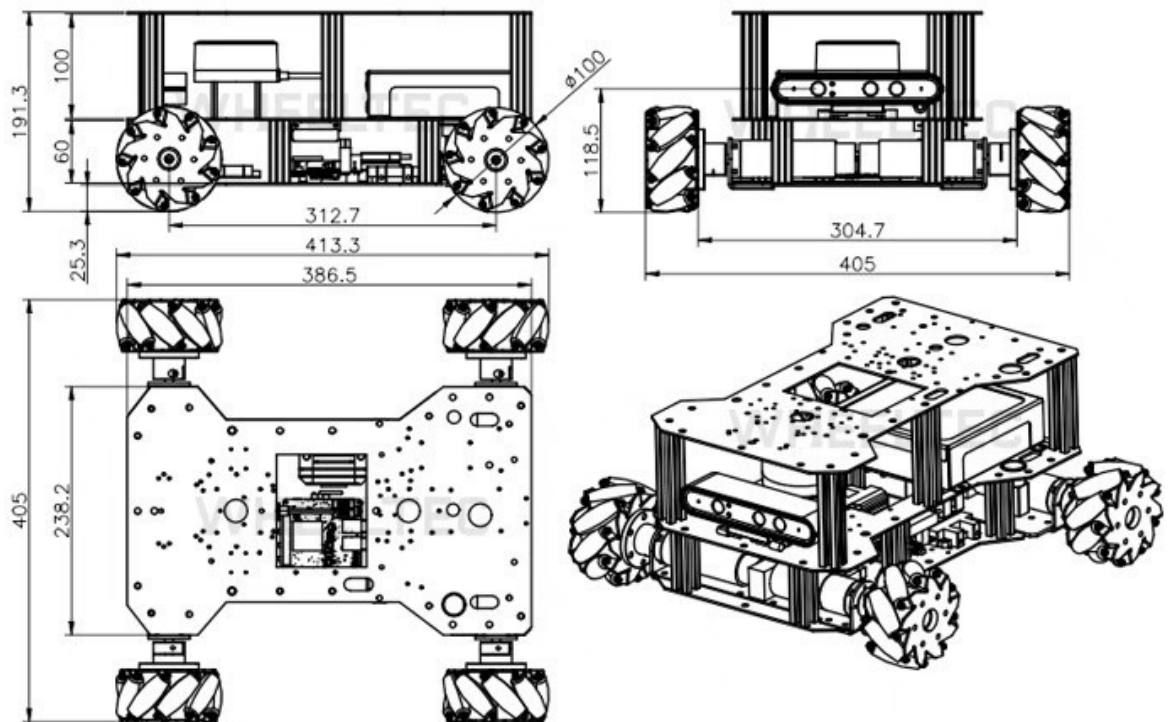

Mecabot Pro Design Diagram:

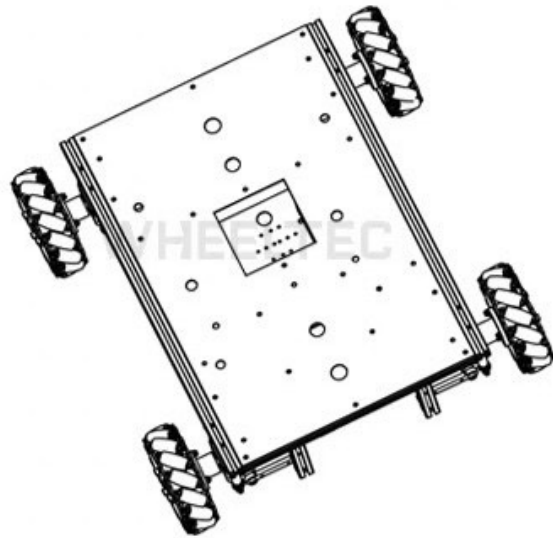
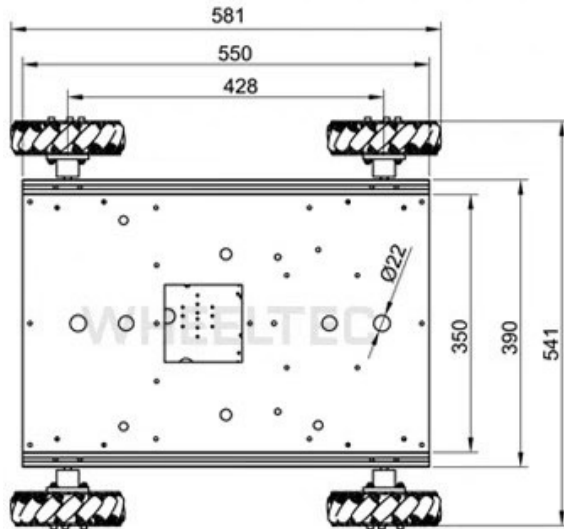
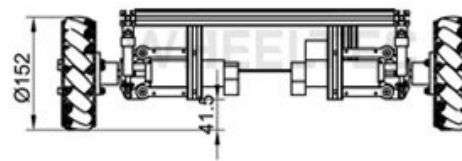
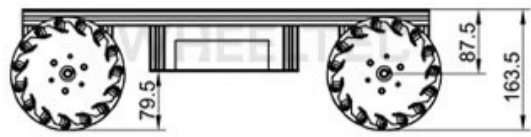

Mecabot Plus Design Diagram:

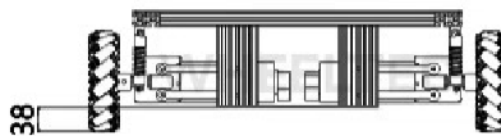
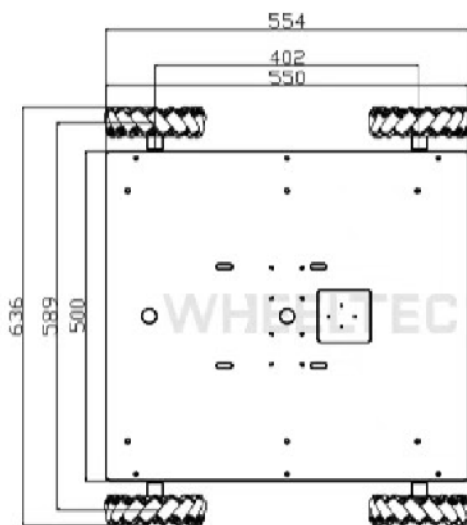

Mecabot X Design Diagram:

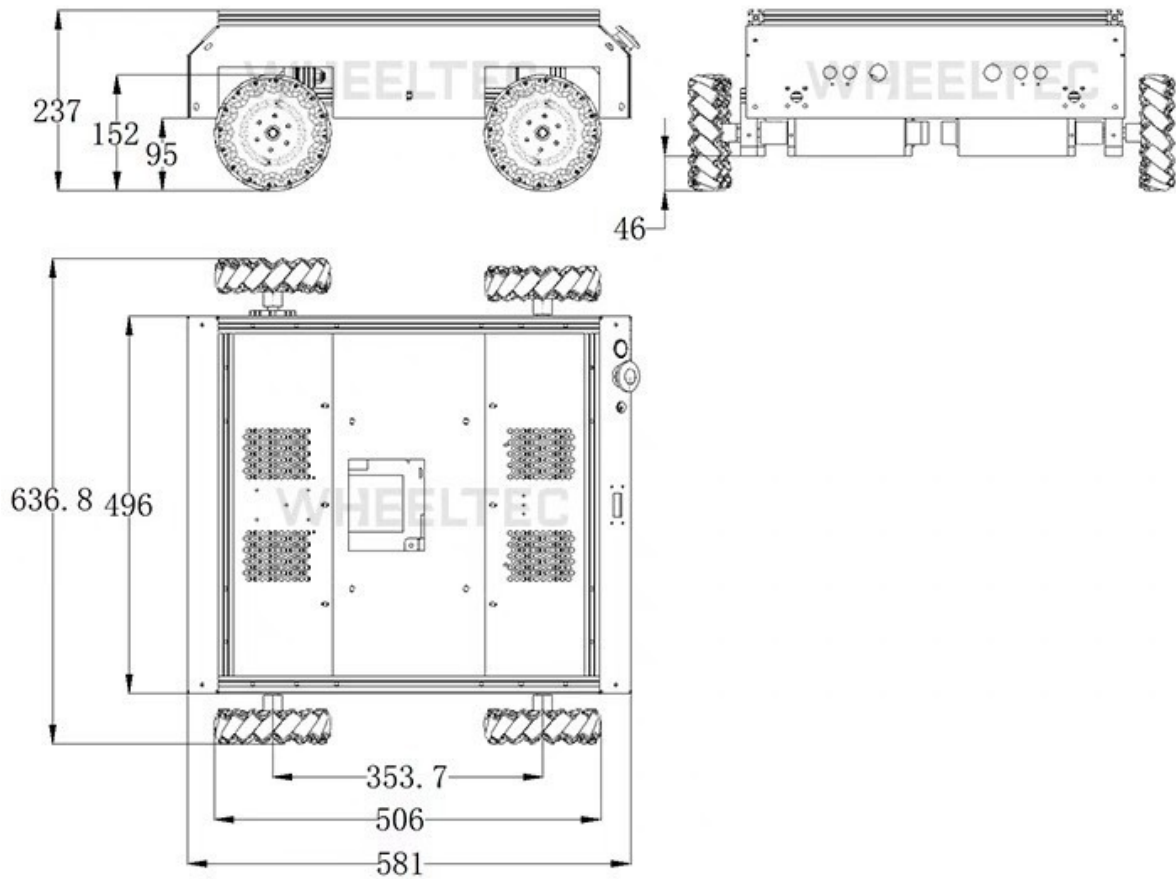

7. Power Management

Power Mag - Magnetic LFP Battery:

All Mecabots come with a 6000 mAh Power Mag, a magnetic LFP (Lithium Iron Phosphate) battery and a Power Charger. Customers can upgrade the battery to 20000 mAh with additional cost. LFP batteries are a type of lithium-ion battery known for their stability, safety, and long cycle life. Unlike traditional lithium-ion batteries, which use cobalt or nickel, LFP batteries rely on iron phosphate, offering a more sustainable and less toxic alternative. They are highly resistant to thermal runaway, reducing the risk of overheating and fire. While they have a lower energy density compared

to other lithium-ion batteries, LFP batteries excel in durability, with longer lifespan, faster charging, and better performance in extreme temperatures, making them ideal for electric vehicles (EVs) and energy storage systems. Power Mag can be attached to any metal surfaces of a robot due to its magnetic base design. It makes swapping batteries quick and easy.

Technical Specifications:

Model	6000 mAh	20000 mAh
Battery Pack	22.4V 6000mAh	22.4V 20000mAh
Core Material	Lithium Iron Phosphate	Lithium Iron Phosphate
Cutoff Voltage	16.5 V	16.5 V
Full Voltage	25.55 V	25.55 V
Charging Current	3A	3A
Shell Material	Metal	Metal
Discharge Performance	15A Continuous Discharge	20A Continuous Discharge
Plug	DC4017MM female connector (charging) XT60U-F female connector (discharging)	DC4017MM female connector (charging) XT60U-F female connector (discharging)
Size	177*146*42mm	208*154*97mm
Weight	1.72kg	4.1kg

Battery Protection:

Short circuit, overcurrent, overcharge, over-discharge protection, support charging while using, built-in safety valve, flame retardant board.

Super Charge:

Super Charge is an Auto Charging Station bundled with Rosbot 2S, Rosbot Pro S, Rosbot Plus S models and can be purchased separately to work with Rosbot 2, Rosbot Pro and Rosbot Plus.

8. Tele-operation

There are 4 ways to tele-operate the robot:

8.1 Controlled by PS2 controller:

8.1.1. Connect the PS2 controller to the PCB board

8.1.2. Wait until the indicator turns red on the controller and then press the Start button.

8.1.3. On the pcb board screen, push the left joystick forward and change it from ros to ps2 control mode.

The following photo shows the two different control modes: ROS or PS2:



8.2 Controlled by ros2 node and keyboard

8.2.1. Change the control mode to ros

8.2.2. Make sure robot bring up is running (see section 9)

8.2.3. Run this command:

```
python3 ros2/src/wheeltec_robot_keyboard/wheeltec_robot_keyboard/wheeltec_keyboard.py
```

4. Alternatively, you can run this command:

ros2 run wheeltec_robot_keyboard wheeltec_keyboard

8.3 Controlled by ros2 node and a USB A controller

8.3.1. Connect a USB A controller

8.3.2. Change the control mode to ros

8.3.3. Make sure robot bring up is running (see section 9)

8.3.4. Run this command:

ros2 launch wheeltec_joy wheeltec_joy.launch.py

8.4 Controlled by Mobile App via Wifi or Bluetooth connection

Visit Roboworks' App Station website and navigate to the Remote Control Mobile Apps section to download the Mobile App for your mobile phone:

9. ROS 2 Quick Start

When the robot is first powered on, it is controlled by ROS by default. Meaning, the STM32 chassis controller board accepts commands from the ROS 2 Controller such as Jetson Orin.

Initial setup is quick and easy, from your host PC (Ubuntu Linux recommended) connect to the robot's Wi-Fi hotspot. Password by default is "**dongguan**".

Next, connect to robot using SSH via the Linux terminal, IP address is 192.168.0.100, default password is **dongguan**.

```
~$ ssh wheeltec@192.168.0.100
```

With terminal access to the robot, you can navigate to the ROS 2 workspace folder, under "wheeltec_ROS 2"

Prior to running test programs, navigate to wheeltec_ROS 2/turn_on_wheeltec_robot/ and locate wheeltec_udev.sh - This script must be run, typically only once to ensure proper configuration of peripherals.

You are now able to test the robot's functionality, to launch the ROS 2 controller functionality, run:

```
"roslaunch turn_on_wheeltec_robot turn_on_wheeltec_robot.launch"
```

```
~$ ros2 launch turn_on_wheeltec_robot turn_on_wheeltec_robot.launch
```

In a second terminal, you can use the keyboard_teleop node to validate chassis control, this is a modified version of the popular ROS 2 Turtlebot example. Type (more tele-op control is available in section 8):

```
"ros2 run wheeltec_robot_keyboard wheeltec_keyboard"
```

```
Control Your Turtlebot!
-----
Moving around:
  u   i   o
  j   k   l
  m   ,   .

q/z : increase/decrease max speeds by 10%
w/x : increase/decrease only linear speed by 10%
e/c : increase/decrease only angular speed by 10%
space key, k : force stop
anything else : stop smoothly

CTRL-C to quit

currently:      speed 0.2      turn 1
```

10. Pre-installed ROS 2 Humble Packages

Below are the following user-oriented packages, whilst other packages may be present, these are dependencies only.

turn_on_wheeltec_robot

This package is crucial for enabling robot functionality and communication with the chassis controller. The primary script “turn_on_wheeltec_robot.launch” must be used upon each boot to configure ROS 2 and controller.

wheeltec_rviz2

Contains launch files to launch rviz with custom configuration for Pickerbot Pro.

wheeltec_robot_slam

SLAM Mapping and localisation package with custom configuration for Pickerbot Pro.

wheeltec_robot_rrt2

Rapidly exploring random tree algorithm - This package enables Pickerbot Pro to plan a path to it’s desired location, by launching exploration nodes.

wheeltec_robot_keyboard

Convenient package for validating robot functionality and controlling using the keyboard, including from remote host PC.

wheeltec_robot_nav2

ROS 2 Navigation 2 node package.

wheeltec_lidar_ros2

ROS 2 Lidar package for configuring Leishen M10/N10.

wheeltec_joy

Joystick control package, contains launch files for Joystick nodes.

simple_follower_ros2

Basic object and line following algorithms using either laser scan or depth camera.

ros2_astra_camera

Astra depth camera package with drivers and launch files.