



Rosbot User Manual

Prepared by: Wheeltec Inc.

Translated by: Roboworks Pty. Ltd.

6 July 2022

Version: #1

ROBOWORKS

SUMMARY

Rosbot is both ideal for ROS beginner or experienced developer. The key components of Rosbot can be tailored towards your needs and budgets. The entire package is flexible and practical. Customers can switch between ROS 1 or ROS 2 easily. The main control unit can be based on Jetson Nano, Raspberry Pi or x86 Industrial PC. Onboard sensors include depth camera and LiDAR. Available accessories can range from light-weight robotic arms, LCD displays to larger battery packs. Each Rosbot comes with free tutorials backed by ROS communities around the globe. Rosbot is your welcome ticket to the world of ROS developers.

KEY FEATURES

- Ideal for Autonomous Mobile Robot (AMR) and Autonomous Driving Prototype projects.
- ROS Controllers - Raspberry Pi/Jetson Nano/Jetson TX/Xavier/x86
- Builtin Slamtec/LD/RoboSense LiDAR, Orbbec Depth Camera
- Remote controlled by mobile apps (iOS and Android)

PRODUCT FAMILY

1. Rosbot Mini

- Entry level package
- Ideal for ROS beginner, educator and students

2. Rosbot Pro



- Professional level package
- Ideal for AMR R&D projects

3. Rosbot Pro 4WIS

- Ideal for product prototyping
 - Strong outdoor performance
 - Suitable for autonomous driving R&D projects
-

ROBOWORKS

SPECIFICATIONS

Product Matrix			
Product Name	Rosbot Mini	Rosbot Pro	Rosbot Pro 4WIS
Motor Reduction Ratio	1:27	1:18	1:18
Max Speed	1.3m/s	1.65m/s	2.33m/s
Weight	5.92kg	19.54kg	35.16kg
Max Payload	10kg	35kg	22kg
Size	445*358*125mm	774*570*227mm	766*671*319mm
Minimal Turning Radius	0.77m	1.02m	1.29m
Battery Life	About 8 hours (no load), About 7 hours (fully load)	About 4 hours (no load), About 2.5 hours (fully load)	
Power Supply	22.2v 5000mah battery + 2A current smart charger		
Steering Gear	HWZ020 20kg torque digital servo	WH060 60kg torque digital servo	
Wheels	125mm diameters solid rubber wheels	150mm diameters solid rubber wheels	254 mm inflatable rubber wheels
Encoder	500 line AB phase high precision encoder		
Suspension System	Coaxial Pendulum Suspension System		4W Independent Suspension System
Control Interface	iOS & Android App via Bluetooth or Wifi, PS2, CAN, Serial Port, USB		

ROS CONTROLLERS COMPARISON

ROS Master	Raspberry Pi 4B	Jetson Nano	Jetson TX1
CPU	ARM Cortex-A72 64-bit@1.5GHz (quad core)	ARM Cortex-A57 64-bit@1.43GHz (quad core)	ARM Cortex-A57 MPCore 64-bit@1.73GHz (quad core)
GPU	Broadcom VideoCore VI(32-bit)	128-core Maxwell @921MHz	256-core NVIDIA Maxwell GPU
RAM	4GB	4GB 64-bit LPDDR4@1600MHz 25.6 GB/s	4GB 64-bit LPDDR4 Memory
USB Interface	2*USB3.0+2*USB2.0	4*USB3.0	2*USB3.0,1*Micro USB
Video Input	MIPI CSI		
Video Output	2 Micro-HDMI Resolution up to 4Kp60	2 HDMI 2.0/DP1.2/eDP 1.2 2*MIPI DSI	1 HDMI2.0
Video Encoding	H.264(1080p30)	H.264/H.265(4Kp30)	
Video Decoding	H.264(1080p60) H.265(4Kp60)	H.264/H.265(4Kp60, 2*4Kp30)	H.264/H.265(4Kp60)
Onboard Storage	32G Micro SD Card		16 GB eMMC 5.1+64G SSD
Network Interface	Gigabit Ethernet Wifi 802.11	Gigabit Ethernet /M.2 Key E	10/100/1000 BASE-T Ethernet
GPIO Pin Number	40		
Rated Power	15W(5V/3A)	5W/10W two modes	15W
Power Input	5V		DC12~24V+/-10%
Size	85.60*53.98mm	100*80mm	128*98*70mm

ROBOWORKS

CHASSIS DESIGN DIAGRAM

Unit:mm

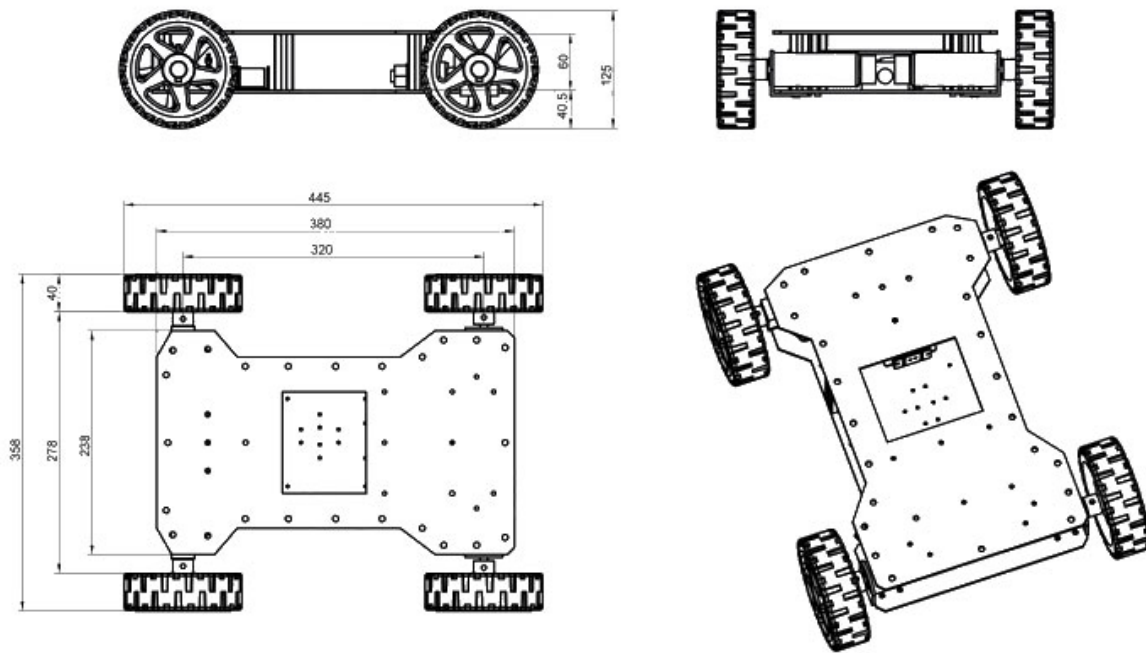

High Grade Version MD36 Motor Parameters							
Motor model	Motor voltage	Speed after deceleration	Rated speed	Rated torque	No-load current	Rated current	Locked-rotor current
MD36NP27	24V DC	325±30rpm	230±20rpm	13.5kg.cm	0.3A	2.3A	7A
MD36NP51	24V DC	172±15rpm	122±10rpm	25.5kg.cm	0.3A	2.3A	7A

Note:
 * MD36NP27 is used for high grade version normal type car
 * MD36NP51 is used for high grade version heavy-duty type car

OPTIONAL VOICE MODULE

Ring six microphone array voice module, suitable for Linux / Ubuntu operating system

The Engineer shall provide the whole process technical support

The module includes the following functions:

Solidarity positioning, Voice navigation, Voice call



Optional high aluminum alloy plate

The optional heightening aluminum alloy plate has only the first and second layers by default. If more space is required, the optional heightening aluminum alloy plate can be selected

Gold plate. The mounting holes of the second, third and higher layers can be customized if necessary

To customize, you can negotiate specific matters and expenses with customer service. The customized delivery date is generally the same

Ship the next day or the next day.

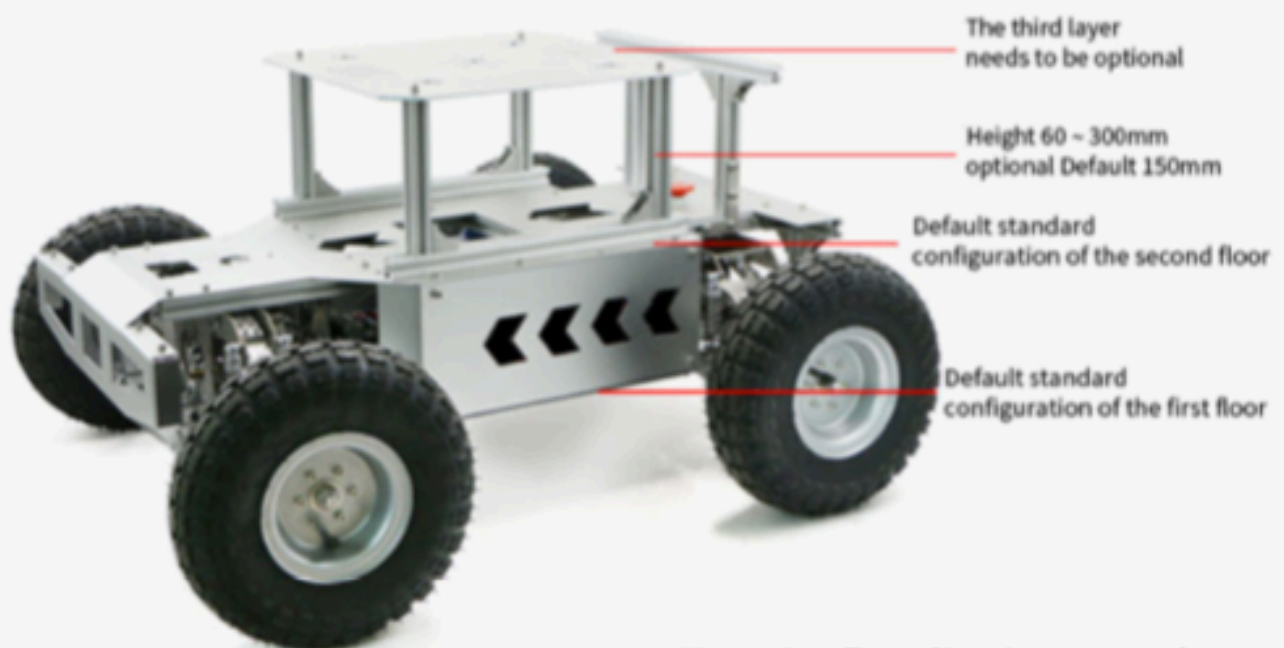
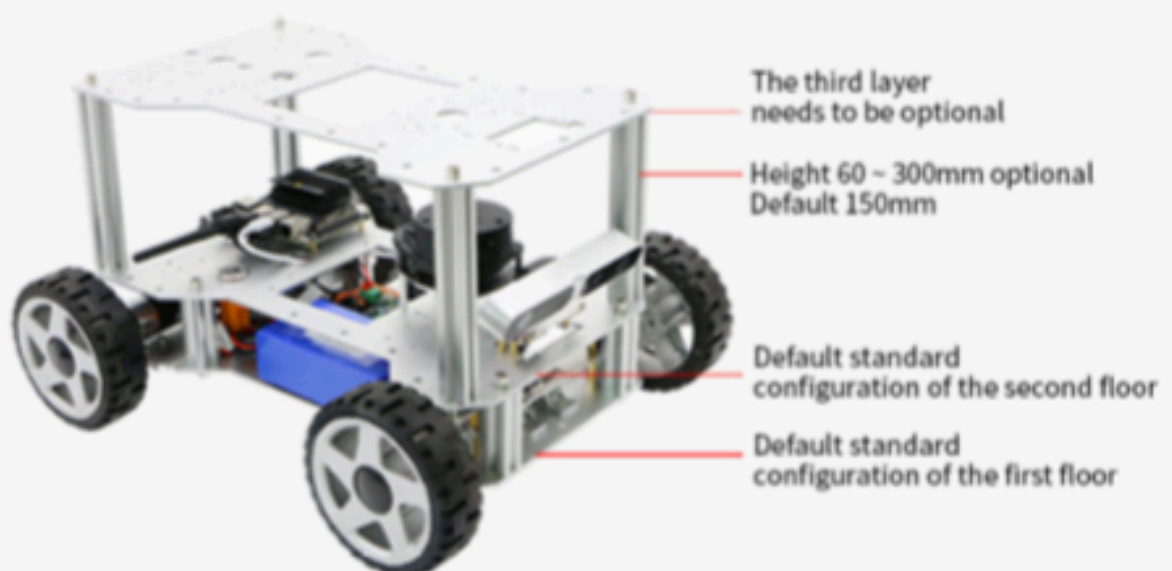

This is the effect of heightening one layer.
The heightening plate is detachable.

✓ Rtabmap vision and lidar mapping navigation

Supports visual SLAM, gmapping, hector, karto, Google Cartographer and other algorithms to build maps, supports fixed-point navigation, multi-point navigation

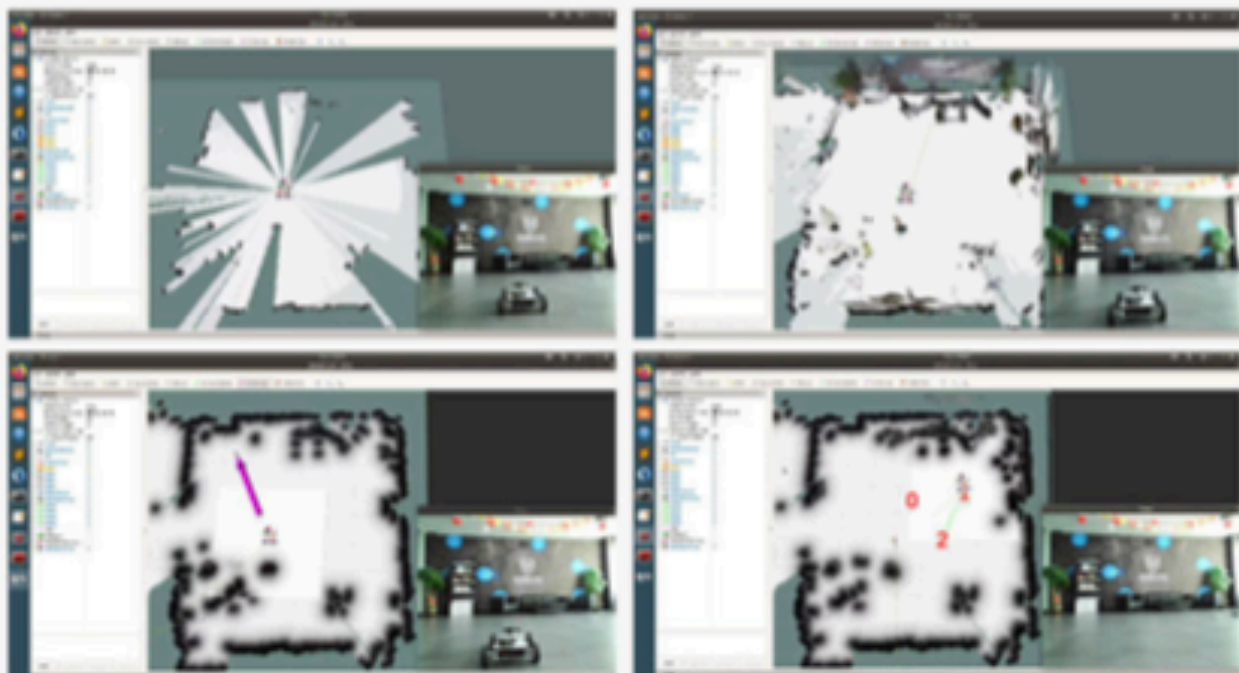

✓ Lidar follow

Lidar can follow any object including people in all directions



✓ Depth camera follow

Through the RGBD depth camera, you can measure the distance to the front object and follow



✓ Visual patrol

The camera can be navigated by sticking lines, ordinary electrical glue can be used, the color of the line patrol is blue and black, red, green, yellow, etc. adjustable

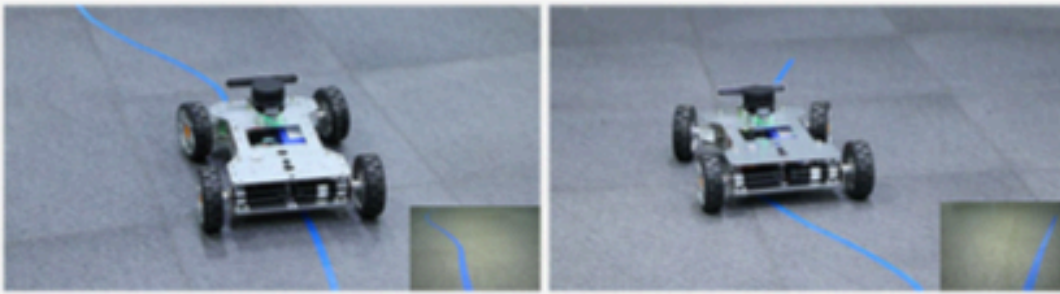

✓ Support APP control, view images, map creation, navigation

Realize car mapping and 2D navigation functions through Android ROSAPP



✓ RRT autonomous exploration and mapping

No need to manually control the car, use the RRT algorithm to autonomously complete the exploration map, save the map, and return to the starting point

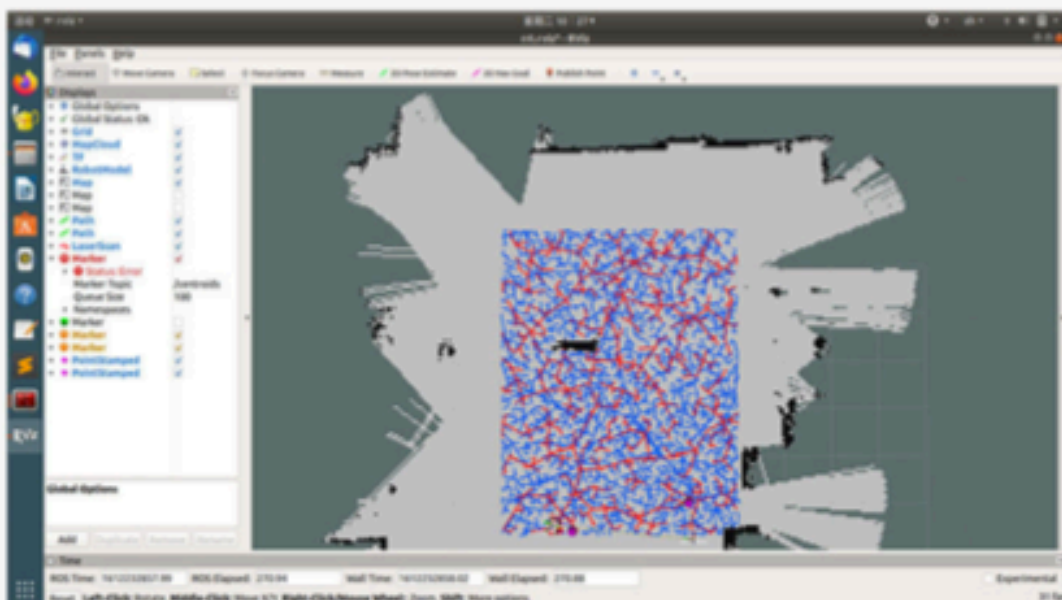

ROBOWORKS

HWZ020 SERVO FOR HIGH GRADE VERSION

- Maximum angle: 180°
- Voltage: 4.8-7.4V
- Torque: 20kg.cm
- Reaction speed: 0.14sec/60°
- Servo type: digital servo
- Gear: metal gear
- Net weight: 59.6g
- Working dead zone: 3us

INTERFACE DESCRIPTION

- CAN: The mobile platform can receive commands from the CAN port, or send its own data (odometer and IMU) through the CAN port
- Serial port: The mobile platform can receive commands from the serial port and send its own data (odometer and IMU) through the serial port
- USB interface: used to connect to the computer, download the program with one key, and receive the command control sent by the computer and send its own data (odometer and IMU) to the serial port
- Bluetooth (or wifi): can send its own information to APP, can receive APP remote control commands, can adjust PID parameters
- For PS2 interface: Provide socket for PS2 controller, provide code plug and play
- SWD interface: Provide SWD interface for online debugging

OPEN SOURCE AND ALGORITHM DESCRIPTION

- Provide the complete source code of the mobile platform and the schematic diagram of the controller. Provide detailed communication protocol and development manual of the interface. Provide PID development notes and video tutorials.
- The mobile platform is mainly to solve the problem of "making wheels" in everyone's projects. Built-in PID closed-loop control and kinematic analysis, can receive commands from serial ports, CAN and even laptops.

ROS KIT WITH ROS MASTER, LIDAR AND DEPTH CAMERA

- ROS master: For Raspberry Pi 4B (2G+32G), Jetson Nano B01, Jetson TX2, industrial computer, etc. (optional)
 - Bottom master: STM32F103RCT6 (based on operating system for FreeRTOS)
 - Operating system: For Ubuntu 18.04+ROS melodic
 - Lidar: SLAMTEC RPLIDAR A2 (If you need A1, A3, S1 and other radars, please contact customer service)
 - Camera: For Astra Pro depth camera
-

ROBOWORKS

- Functions: remote control, lidar mapping and navigation, visual mapping and navigation, multi-point cruise, lidar follow, depth vision follow, visual line patrol, APP image transmission, etc.
- Attention: It has been assembled and debugged for the above functions, and you can use them when you get them.
- Open source: open source the full set of underlying code for the above functions, ROS source code, development manual, video tutorial
- Camera angle: manually adjustable

FUNCTION LIST

- Low-level ROS serial communication
 - Reserved CAN communication interface
 - IMU and odometer data feedback
 - Voltage detection and voltage alarm
 - MPU9250 nine-axis attitude sensor
 - Support serial port one-click download
 - Stepless adjustment of radar frequency
 - Gyro zero drift clearing
 - Keyboard node control
 - APP gravity sensor control
 - APP adjusts PID parameters
 - For opencv applications and tutorials
 - Robot dynamic obstacle avoidance
 - Robot fixed-point navigation and multi-point navigation
 - TEB and DWA path planning
 - ROS APP image transmission and control
 - WEB browser displays camera image
 - Lidar mapping navigation
 - rtab pure visual mapping navigation
 - rtab vision + radar mapping navigation
 - Gmapping
 - Hector mapping
 - Karto build map
 - Cartographer
 - Tensorflow object recognition
 - Lidar tracking
 - Deep visual tracking
 - KCF tracking
 - AR label recognition
 - RGB visual line tracking (integrated radar obstacle avoidance)
 - ROS APP mapping (NEW)
-

ROBOWORKS

- ROS APP navigation (NEW)
- RRT Independent Mapping (NEW)
- Multi-agent collaborations (NEW)

MORE DETAILS

- Rtabmap vision and lidar mapping navigation: support for vision SLAM, gmapping, hector, karto, Google Cartographer and other algorithms for mapping. Support fixed-point navigation, multi-point navigation
- Lidar follow: Lidar can follow any object including people in all directions
- Depth camera follow: Through the RGBD depth camera, you can measure the distance to the front object and follow
- Visual line inspection: The camera can navigate by sticking lines, and the general electrical glue can be used. The color of the patrol line is blue, black, red, green, yellow, etc. adjustable
- Support APP control, view images, build maps, and navigate. It can display the camera image on the mobile phone at the same time when it can be controlled by APP, and control from the first perspective
- Autonomous exploration and mapping: no need to manually control the car, use the RRT algorithm to autonomously complete the exploration and mapping, save the map, and return to the starting point
- Multi-aircraft formation: multi-aircraft cooperative operation, distributed formation control, support single-point and multi-point navigation functions
- Support airplane model remote control: Built-in remote control interface of airplane model, plug in the remote control of airplane model, and it can be controlled normally
- Support for PS2 wired controller: Built-in interface and program, connect it and use it
- Snow protection grade tires: Snow skid-proof standard/metal wheels. High grade version uses solid rubber wheels with a diameter of 125mm. Single wheel weighs 0.48kg
- Humanized design and multiple protections: This system board is suitable for motion control projects, such as robots, balancing cars, and inverted pendulums. Reverse connection protection, overcurrent protection, short circuit protection, electrostatic protection, CAN controller, integrated MPU6050
- MircoUSB data cable, one-click download: Are you tired of the tedious steps of plugging and unplugging the Dupont cable, modifying the BOOT0 setting, and pressing the reset button every time you adjust the program? We provide a one-click download function, using a MircoUSB data cable to download the program and communicate with the serial port
- Industrial-grade dual-channel DC motor drive module: built-in over-voltage protection, under-voltage protection, over-heat protection, control signal optocoupler isolation

SLAMTEC RPLIDAR A2

- 5-year lifespan
 - OPTMAG optical and magnetic fusion
 - 18 meters measuring radius
 - 4CM ultra-thin appearance
 - Measurement frequency 8000 times/sec
-

Provide a rich ROS development manual

1. ROS development tutorial

The Preface

1. Fix Raspberry PI peripheral serial port number
2. SLAM car ROS source code analysis
 - 2.1 File system preview
 - 2.2 Code composition
 - 2.3 Serial communication with the lower computer
 - 2.4 ROS topics and sensor data release
 - 2.5 Robot node analysis
 - 2.6 Parameter analysis of robot
 - 2.7 Analysis of robot TF coordinate transformation
 - 2.8 Start the robot through the launch file
3. Laser radar mapping
 - 3.1 Start the mapping node
 - 3.2 Map preservation
4. Robot navigation
 - 4.1 Start the navigation node
 - 4.2 rviz navigation goal setting
 - 4.3 Multi-point navigation
 - 4.4 Navigation parameter setting
 - 4.5 Navigation status monitoring and custom goals
 - 4.6 Common navigation fault troubleshooting

3. STM32 Moving Chassis Development Manual

The Preface

1. Robot control mode
 - 1.1 Robot movement speed unit
 - 1.2 ROS (serial port 3) control
 - 1.3 APP control
 - 1.4 PS2 control
 - 1.5 Hot-RC remote control
 - 1.6 CAN control
 - 1.7 Serial port 1 control
2. OLED display content
 - 2.1 OLED specific content
 - 2.2 OLED universal display content
 - 2.3 car self-inspection
3. Elimination of gyroscope zero drift
4. Robot kinematics analysis
 - 4.1 Two-wheel differential (tracked vehicle) car
 - 4.2 Ackerman car
 - 4.3 Mecanum wheel car
 - 4.4 Omni wheel car
 - 4.5 Four-wheel drive car
 - 4.6 PI control program source code
5. Wiring instructions
6. Control flow chart
 - 6.1 Control flowchart of robot motor
 - 6.2 Robot STM32 program structure diagram
 - 6.3 Robot controller connection diagram

2. Ubuntu configuration tutorial

The Preface

1. Install Ubuntu and ROS on the virtual machine
 - 1.1 Ubuntu installation on the Virtual Machine and Utility Plug-in Installation
 - 1.2 ROS installation with Ubuntu
 - 1.3 Establish the ROS workspace
 - 1.4 Configure static IP address with Ubuntu on the Virtual Machine
 2. Configure Ubuntu and ROS on Raspberry PI
 - 2.1 Configure Ubuntu on Raspberry PI
 - 2.2 Install ROS on Ubuntu of Raspberry PI
 3. Environmental configuration of Jetson Nano
 - 3.1 Configure Ubuntu in Jetson Nano
 - 3.2 Install ROS in Jetson Nano
 4. Configure Ubuntu and ROS in Jetson TX2
 - 4.1 Flash the Jetson TX2
 - 4.2 Install ROS on Jetson TX2
 5. Configure Ubuntu and ROS on the IPC
 - 5.1 Install Ubuntu on the IPC
 - 5.2 Install ROS in IPC
 - 5.3 Configure wireless WIFI and static IP with Ubuntu on IPC
 6. Configure Ubuntu and ROS in Jetson Xavier NX
 - 6.1 Install Ubuntu in Jetson Xavier NX
 - 6.2 Install ROS in Jetson Xavier NX
 7. Configure wireless WIFI and static IP with Ubuntu
 - 7.1 Configure wireless WIFI with Ubuntu
 - 7.2 Ubuntu configures static IP
 8. The NFS mount
 9. Execute the script at boot time
 10. SSH remote login
 11. ROS multi-machine communication setup
 12. Raspberry PI image backup and recovery
 - 12.1 Raspberry PI image backup
 - 12.2 Raspberry PI image recovery
 13. Jetson Nano image backup and recovery
 - 13.1 Jetson Nano image backup
 - 13.2 Jetson Nano image recovery
 14. Jetson TX2 image backup and recovery
 15. IPC image backup and recovery
 16. Jetson Xavier NX image backup and recovery
 17. The basics of Ubuntu
-
7. Matters needing attention
 - 7.1 About the code
 - 7.2 About the power interface on the adapter board
 - 7.3 About the motor
 - 7.4 About the battery
 8. How to download program to STM32 controller
 - 8.1 Serial download
 - 8.2 SWD download

✓ Newly launched code-level ROS development manual

The Preface

1. Basic operations
 - 1.1 SSH login
 - 1.2 NFS
2. Multi-machine communication
 - 2.1 Introduction to multi-machine communication
 - 2.2 WIFI sent by ROS host (car)
 - 2.3 ROS master and slave are connected to one WIFI
3. The realization principle of keyboard control and trolley motion control
 - 3.1 The realization of the movement of the trolley
 - 3.2 The keyboard controls the movement of the car
4. Line patrol function
 - 4.1 Realization of line-following function
 - 4.2 Analysis of the line-following function program
5. Radar follow function
 - 5.1 Radar follow function to achieve operation
 - 5.2 Description and adjustment of radar following parameters
 - 5.3 Analysis of Radar Follow Function Program
6. Visual follow function
 - 6.1 Realization of visual follow function
 - 6.2 Visual follow function program analysis
7. 2D mapping navigation function
 - 7.1 2D mapping function
 - 7.2 2D navigation function
8. 3D mapping navigation function
 - 8.1 3D mapping function
 - 8.2 3D navigation function
9. Pure visual mapping navigation function
 - 9.1 Pure visual mapping function
 - 9.2 Pure visual navigation function
10. Voice control and interactive functions
 - 10.1 Introduction to Microphone Array Hardware
 - 10.2 Configuration before use
 - 10.3 Introduction to Voice Function
11. KCF follow function
 - 11.1 KCF follow function to achieve operation
 - 11.2 KCF follow-up function program analysis
12. Autonomous mapping function
 - 12.1 Implementation of autonomous mapping function
 - 12.2 Analysis of Autonomous Map Function Program
13. WHEELTEC APP image transmission, mapping and navigation functions
 - 13.1 APP function realization operation
 - 13.2 APP function realization principle
14. Multi-machine formation function
 - 14.1 Introduction to Multi-Aircraft Formation Algorithm
 - 14.2 ROS multi-machine communication settings
 - 14.3 Multi-machine time synchronization setting
 - 14.4 Use of Multi-Aircraft Formation Function Package
15. Web page video real-time monitoring function
 - 15.1 Real-time monitoring function of web video
 - 15.2 Brief explanation of the function package
16. Object recognition function
 - 16.1 Object recognition function realization operation
 - 16.2 Analysis of Object Recognition Function Program
17. AR tag recognition and follow
 - 17.1 AR tag recognition function
 - 17.2 AR tag follow function
18. Use wireless controller in Linux environment
 - 18.1 Installation and Configuration
 - 18.2 Wireless joystick driver installation and configuration
 - 18.3 Controlling the turtle's movement through a wireless handle
 - 18.4 Control the movement of the ROS car through a wireless handle

✓ Introducing the Gazebo Getting Started Manual

(70 pages, updated on October 29, 2021)

The Preface

1. Introduction to gazebo tool
 - 1.1 Introduction to gazebo interface toolbar
 - 1.2 How to build a map model with gazebo tool
 - ① Use Gazebo's Building Editor
Create an architectural model
 - ② Import the building model from the outside
 - 1.3 How to build machine model with gazebo tool
 - ① Use gazebo's Model Editor to create
Building an architectural model
 - ② Import machine model from outside
2. Model writing and loading
 - 2.1 Machine model writing and loading
 - ① Main usage of xacro
 - ② Use xacro to write link
 - ③ Use xacro to write sensor model
 - ④ Use xacro to write the transmission system
 - ⑤ Use custom control plug-in
 - ⑥ Load the machine model written by xacro
 - 2.2 Loading the map model
 - ① Loading of gazebo map model
 - ② Loading of rviz map
3. Realization of mapping/navigation function
 - 3.1 gazebo mapping function
 - ① Choose car model and mapping algorithm
 - ② Load model motion control
 - ③ Run mapping function
 - ④ Errors that may occur when running the mapping function
 - 3.2 Gazebo navigation function
 - ① Select vehicle type and local path planning algorithm
 - ② Model positioning and path planning
 - ③ Run navigation function
 - ④ Errors that may occur when running the navigation function

Standard coaxial pendulum suspension system

Because the three-point surface is formed, if the floor is rigid, the four-wheeled car will have an unavoidable problem. The wheels are prone to hang in the air and cannot be debugged normally, not to mention indoor navigation and automatic driving. Our car is equipped with a coaxial pendulum suspension system on the premise of being equipped with an aluminum alloy floor, which can adapt to uneven ground.

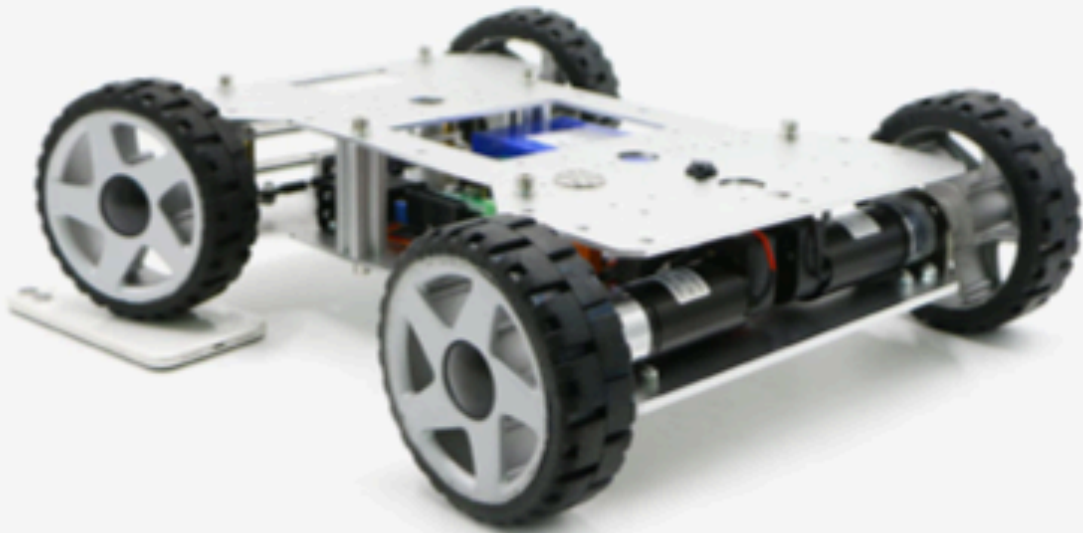

Support remote control of airplane model

Built-in model airplane remote control interface, plug in the model airplane remote control and it can be controlled normally



Equipped with snow protection grade tires

Snow skid standard / metal wheels

Top version, independent suspension use
Inflatable rubber wheels with a diameter of 254mm
Single wheel weight: 1.98kg

Top version use
180mm diameter solid rubber wheel
Single wheel weight: 0.84kg

High version use
125mm diameter solid rubber wheel
Single wheel weight: 0.48kg



Humanized design and multiple protection

This system board is useful for motion control projects
Such as robots, balance carts, inverted pendulums, etc. are also better choices at present



- ✓ Reverse connection protection
- ✓ Overcurrent protection
- ✓ Short circuit protection
- ✓ Electrostatic protection
- ✓ CAN controller
- ✓ Integrated MPU6050

MicroUSB data cable One-click download

Are you tired of the tedious steps of plugging and unplugging the Dupont cable, modifying the BOOT0 setting, and pressing the reset button every time you adjust the program? We provide a one-click download function, using a MicroUSB data cable, you can download programs and communicate with the serial port



With industrial-grade dual-channel DC motor drive module

Built-in overvoltage, undervoltage, overheat protection, control signal optocoupler isolation



Hardware inventory

The dashed box is the accessories included in the ROS package

Lidar (single choice)



A1

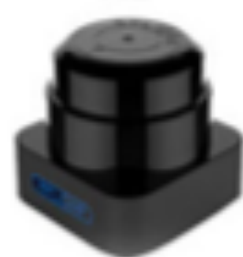

S1

Lidar (single choice)



raspberry pie



Jetson Nano
(Optional for Jetson TX1)

ORBEC Astra series depth camera



microphone

Infrared projector

Proximity sensor

Multi-function base

IR camera

RGB camera

microphone

Power adapter board



32F103RC core board
(Integrated IMU)



12A MOS driver

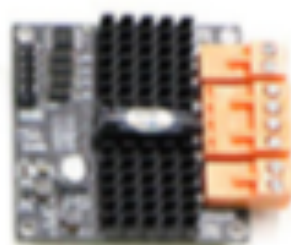

Bluetooth module

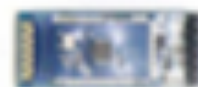

OLED display



✓ Battery parameters

We cooperate with first-line battery suppliers

Upgrade the capacity to 5000mah (default standard configuration)

Equipped with a special charger with multiple protections such as overdischarge, overshoot, short circuit, overvoltage, etc.

Battery	22.2V 5000mAh
size	124*71*42mm
plug	DC5.5 charging plug, T-shaped discharge plug
performance	15A continuous discharge
weight	0.66kg

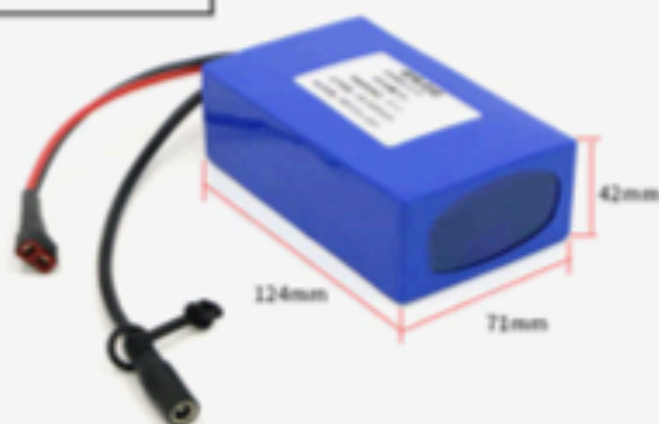

10000mah Battery parameter description

Battery	22.2V 10000mAh
size	124*71*71mm
plug	DC5.5 charging plug, T-shaped discharge plug
performance	30A continuous discharge
weight	1.25kg

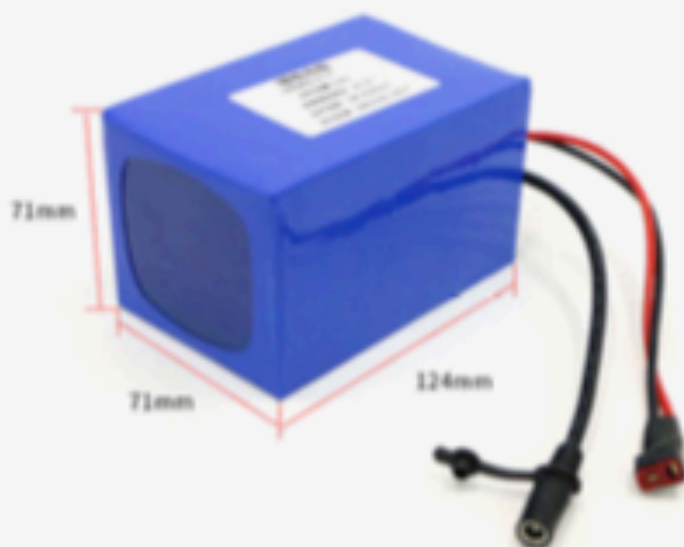

20000mah Battery parameter description

Battery	22.2V 20000mAh
size	155*122*71mm
plug	DC5.5 charging plug, T-shaped discharge plug
performance	60A continuous discharge
weight	2.4kg

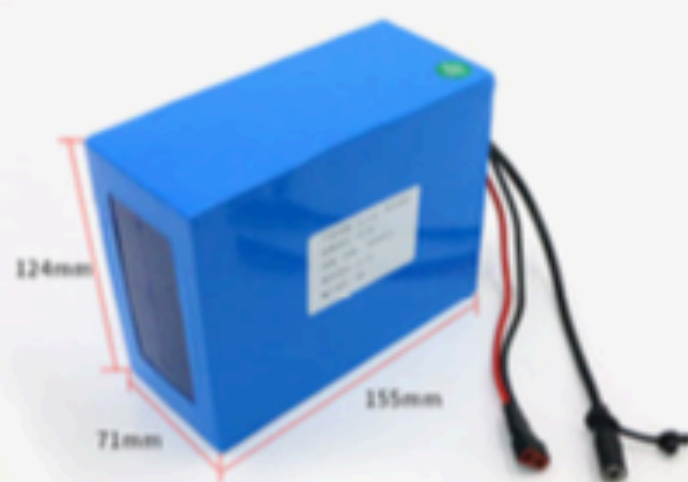

ROBOWORKS

NEW BLUETOOTH & WIFI VERSION APP

- Support gravity sensor remote control and two-hand button remote control mode.
- Support 5-channel waveform display interface, you can view the waveform at any time without the data line.
- Support 9-channel parameter adjustment interface, support PID parameter online adjustment and power-off save.
- Optimize electric quantity alarm mechanism, the APP accurately pushes low-voltage alarm notifications to avoid over-discharge.
- Support for BLE Bluetooth 4.0 module.
- Support the latest version of the system for Android.

PACKING LIST

Chassis Parts:

- 4 x 125mm Diameter Solid Rubber Wheels
- 1 x HWZ020 20kg Torque Digital Servo
- 2 x MD36N 35W DC Brush Motors
- 2 x Simple L-shaped Motor Brackets
- 1 x Set of Aluminum Alloy Plate (as chassis frame)
- 3 x Small Tie Rods
- 2 x Small Steering Cups
- 2 x 500 Line AB phase Photoelectric Encoders
- 1 x Mini Linear Guide
- 1 x Coaxial Pendulum Suspension System
- Several Screws, Nuts, Pillars, Wires

Electric Control Parts:

- 1 x STM32F103RC Controller (integrated IMU CAN, etc.)
- 1 x Dual MOS Large Current DC Motor Drive Module
- 1 x Adapter Board
- 1 x Bluetooth Module
- 1 x OLED Display
- 1 x Charger
- 1 x Data Download Cable
- 1 x Flat Cable
- 1 x Wired Controller Joystick

ROS Parts:

- ROS Master For Jetson Nano B01
 - 1 x SLAMTEC RPLIDAR A2
 - 1 x Depth Camera & Angle Adjustment Mechanism
 - 1 x 32G Memory Card
 - 1 x Large-Volume Metal Heat Sink (For Jetson Nano B01)
 - Several Cables
-