



User Manual HR-RTLS1

Haorutech co. Ltd

CATALOG

1	Introduction.....	1
2	System features.....	2
3	System Parameters.....	3
4	System Application Scenes	4
5	System setup	5
5.1	Preparation.....	5
5.2	System power supply.....	6
5.3	Multi-anchor Positioning System Deployment	7
5.3.1	Deployment Structure	7
5.3.2	Deployment Mode.....	10
5.3.3	Anchor installation	11
5.4	Driver installation.....	13
5.4.1	CH340 Driver.....	13
5.4.2	CP2102 Driver	13
5.4.3	串口数据接收.....	14
5.5	PC software connection.....	15
5.6	PC Software Positioning Parameter Configuration	18
5.7	PC software base map configuration	19
6	Mobile phone application settings(开发中)	22
7	Communication protocol.....	24
7.1	Uplink data protocol.....	24
8	Secondary Development	26
8.1	Embedded Software Development	26
8.2	PC Software Development	28

8.2.1	PC Software main functions.....	29
8.2.2	Historical Trace 2D/3D Analysis.....	29
8.3	Hardware Design.....	30
9	Gateway Module	31
10	FAQ	31

1 Introduction

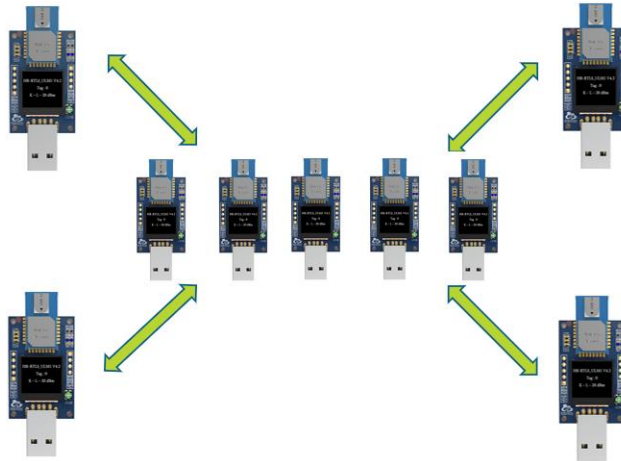

Figure 1-1 RTLS1 UWB Positioning System

HR-RTLS1 is a high-precision real-time UWB positioning system developed by Haorutech based on DW1000 and DW3000 series chips manufactured by Decawave. The system can be used for precise ranging, indoor positioning and high-speed data communication applications.

HR-RTLS1 contains a variety of short-distance, medium-distance and long-distance ranging modules. It also contains wearable devices like wristband and badge tag. The system supports two positioning mode: TOF with trilateration algorithm mode, and PDOA with angle measurement & single anchor ranging mode. Most of location application scenarios can be satisfied by the different combinations between modules of HR-RTLS1.

HR-RTLS1 is all open source, and supports applicational development. Also, we provide all video tutorials for users to easily learn, research and achieve productization & application.



2 System features

➤ Popular MCU-STM32, friendly to beginners:

The ULM1/ULM3/LD150 module of HR-RTLS1 takes STM32F103CBT6 series (or fully compatible alternative chip made in China) as the main control MCU.

The wearable devices take STM32L151CUB6 low-power microcontroller, which is controlled by CUBEmx tool, developed by HAL library and KEIL-MDK integrated development environment.

➤ 简单的开发形式:

ULA1 采用 ESP32 为主控 MCU，采用 Arduino 的开发形式，使非硬件和嵌入式专业的开发者能够降低开发门槛，迅速应用。

➤ Large amounts of open-sourced materials:

All the module embedded code, PC software code, hardware schematics are open-sourced. It's convenient for users to make applicational development;

➤ Large amounts of development and application materials:

We provide <Module User Manual>, < RTLS User Manual > and so on, which covering most of the development requirements;

➤ Video courses(目前正在翻译中):

We provide video courses to explain UWB system in all aspects, so all users can quickly learn and get started;

➤ Easy extended interface:

Modules provide external expansion data interfaces, which can be easily connected to **PC, mobile phone, other microcontroller, Raspberry PI, Arduino, PLC and other devices** for expansion and development.

➤ **High positioning accuracy:**

The system takes Decawave high-precision positioning IC as the core positioning module. It works with self-developed positioning algorithm and filtering algorithm, which makes the positioning tag adapting to various complicated field conditions. The positioning accuracy is 10cm (CEP95);

➤ **Support multi-tags and multi-anchors:**

The system can easily expand the number of anchors and tags by configuration, which is convenient for users to expand the system;

➤ **Built-in Kalman filter algorithm in module**

The built-in Kalman filter algorithm can be turned on/off to make the output data stable and smooth.

3 System Parameters

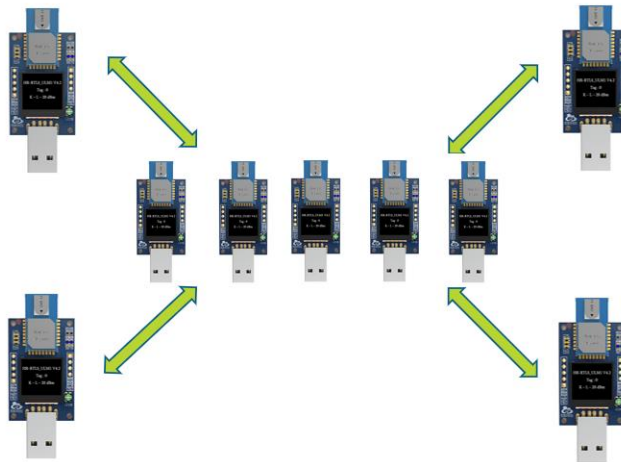

Figure 3-1 RTLS1 Positioning System



Table 3-1 RTLS1 Parameters

Category	Parameters
Number of anchors for two-dimensional positioning system	At least 3 anchors
Number of anchors for three-dimensional positioning system	At least 4 anchors
Ranging Accuracy	X/Y=10cm(CEP95) Z=30cm(CEP95)
Development environment	CUBE+KEILMDK
Maximum number of tags	100 tags ULM1/ULM3/LD150 1tag ULA1
Maximum number of anchors	8 anchors ULM1/ULM3/LD150 4anchors ULA1
Ranging mode	TOF/DS-TWR
Positioning range	40m*40m(ULM1) @110Kbps 25m*25m(ULM3) @6.8Mbps 100m*100m(LD150) @110Kbps

4 System Application Scenes

- 1) **Workshop:** Staff, cars, overhead travelling crane positioning, material management.etc;
- 2) **Jail:** Criminals management and monitoring;
- 3) **Logistics center:** Goods & material management and monitoring, AGV navigation;
- 4) **Shopping mall, supermarket:** Staff & shopping cart navigating
- 5) **Retirement home:** Elder vital signs monitoring
- 6) **Hospital:** Baby/elder monitoring
- 7) **Tunnel, underground pipe gallery, mine:** Workers & vehicle monitoring
- 8) **Rail traffic:** Vehicle & personnel monitoring and collision prevention

- 9) **Construction site:** Position management of machinery, personnel and materials;
- 10) **Stadium:** Athletes intelligent training;
- 11) **Live action game:** Player position service, trace analysis;
- 12) **University Research:** UWB related research

5 System setup

5.1 Preparation

According to the usage scenario conditions, users should use corresponding modules for system setup. The roles and ID of modules have been set after manufacturing. The label begins with “A” is anchor; The label begins with “T” is tag module. The ID starts from 0. For example, a 4 anchors & 2 tags system will be conTabled with: A0, A1, A2, A3, T0, T1.

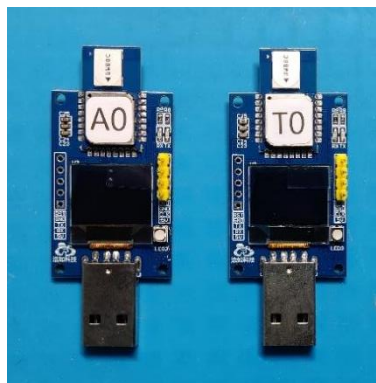

Figure 5-1 Module Role & ID label

In a multi-anchor positioning system, anchors are normally defined as fixed modules, installed in 4 corners to form a rectangle positioning space; tags are generally installed on the objects to be located.

In a PDOA single-anchor following system, the anchor is generally installed on the vehicle, and the tag module is generally installed on the person (object) being followed.



The power of ULM1 and ULM3 need to be supplied by external power bank, LD150(-I),LD600(-I), wristband and badge tag have built-in batteries, which can work independently. The power bank and built-in battery are about 30% power after manufacturing. So please charge them before testing.

Please prepare USB extension cable or MicroUSB data cable for connecting UWB module and computer to transmit data.

According to the different types of modules, the modules and accessories need to be prepared before build your own scenes, which is shown in the following table:

Table 5-1 Equipment preparation list

Type	Modules and accessories used for deployment	Accessories used for maintaining:
ULM3	Anchor (Ax) Tag (Tx) power bank or li-ion battery (Optional):Number of ULM3 - 1 1 USB extension cable	For Power bank charging: MicroUSB white charging cable = number of power bank For firmware updating: STLINK = 1 For mobile connecting: TypeC converter = 1
ULA3	Anchor (Ax) Tag (Tx) power bank or li-ion battery (Optional):Number of ULA1 - 1 1 USB extension cable	For Power bank charging: MicroUSB white charging cable = number of power bank

5.2 System power supply

The ULM3 module does **not** have a built-in battery, so you need to connect it to a

power bank or a computer USB port to power it and transmit data. Please also charge the power bank when it's out of power. The power bank can be charged by a 5V power supply device with the white MicroUSB charging cable. The charging works when the power bank's indicator light is flashing, the charging is complete when the power bank indicator light is always on.



Figure 5-2 ULM1/3 Module Connects to a power Bank

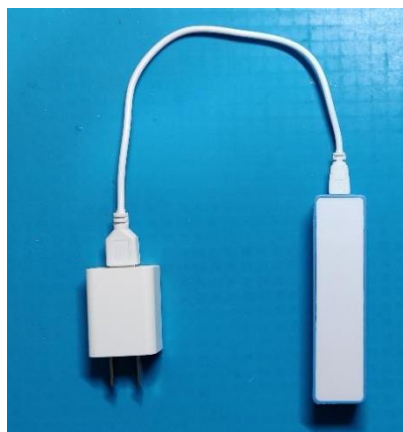

Figure 5-3 Power Bank Connects to USB Cable.

5.3 Multi-anchor Positioning System Deployment

5.3.1 Deployment Structure

Multi-anchor positioning system contains 3 or more anchors. It also contains tag modules as many as you want.

When we use 3 anchors, please try to deploy the 3 anchors to a regular or isosceles right triangle shape, and tags can be positioned in the triangular area surrounded by anchors.

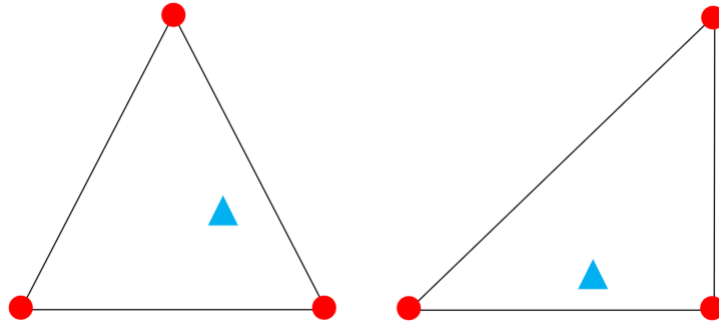

Figure 5-4 3 Anchors System Deployment

When we use 4 anchors, please try to deploy the 4 anchors to a rectangle shape with the aspect ratio less than 2:1, and tags will be positioned in the rectangular area surrounded by anchors.



Figure 5-5 4 Anchors System Deployment

When we use more than 4 anchors, all the 4 anchors small positioning system among the big system should follow the principle that the aspect ratio of rectangular should be less than 2:1, and try to put the anchor A0 in the central position of the positioning area.

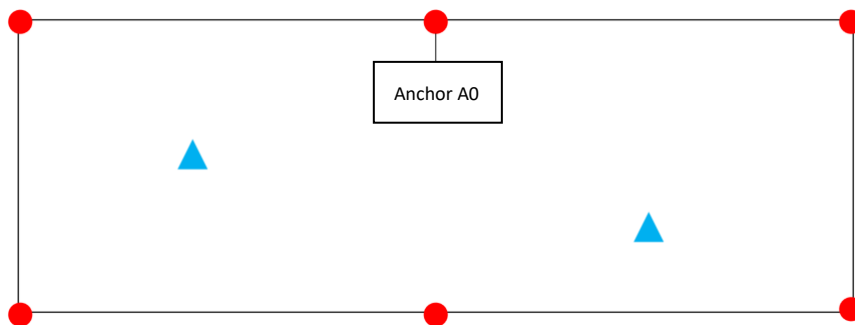

Figure 5-6 6 Anchors System Deployment

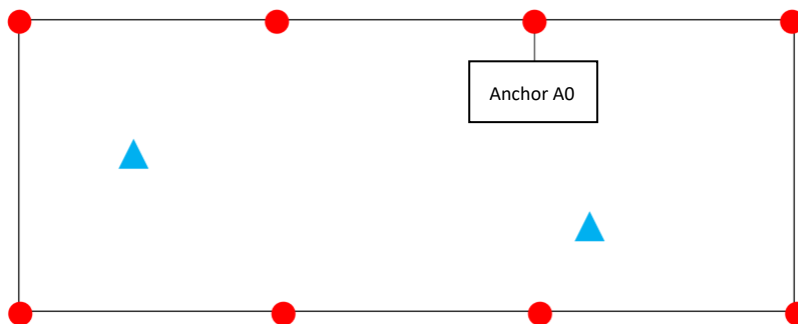

Figure 5-7 8 Anchors System Deployment

In three-dimensional positioning, at least 4 anchors are needed. If the Z-axis needs to be positioned accurately, please try to make the shape of the positioning space to a positive cube with an aspect ratio of 1:1:1, and the 4 anchors should be deployed at the top 4 corners of the cube.

A cost-effective method to positioning the Z-axis precisely is to add a geodetic ranging sensor on the positioning object. It is also possible to deploy four more anchors at the bottom four corners of the cube to increase the z-axis accuracy through the algorithm, but this method costs more.

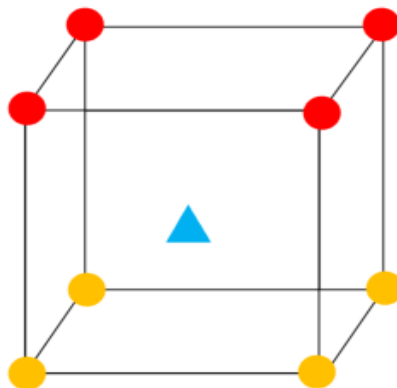

Figure 5-8 Anchors deployment in Three-dimensional Positioning System

5.3.2 Deployment Mode

There are two system deployment modes: navigation mode and monitoring mode. During the navigation mode, the tag needs to be connected to the PC while other anchors only need to power on. The position data and real-time trace of the currently connected tag can be displayed on the PC software.

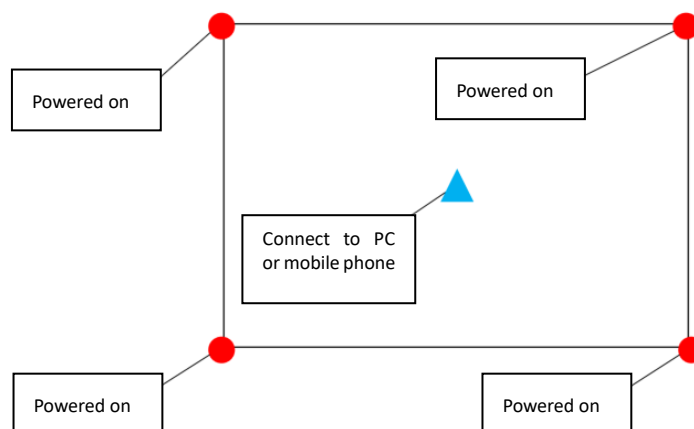

Figure 5-9 Navigation Mode Connection Diagram

In the monitoring mode, one of the anchors is connected to the PC, while the other anchors and labels are powered on. The position data and real-time trace of all labels in the coverage area of the current anchor can be displayed in the PC software.

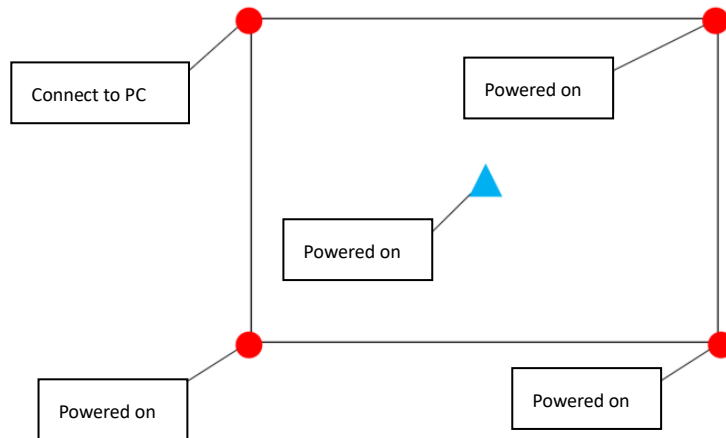

Figure 5-10 Monitoring Mode Connection Diagram

ULM1/3 integrates with USB-A connector, which needs to connect to PC by another USB extension cable.

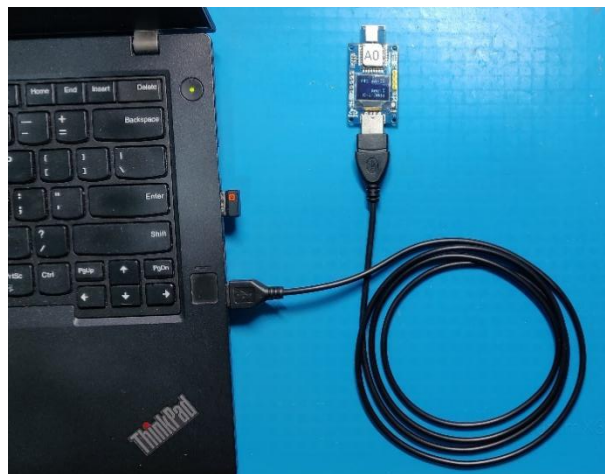

Figure 5-11 How ULM1/3 Module Connects to PC

5.3.3 Anchor installation

The anchor needs to be installed in a fixed position, for example, installed on a wall/roof or fixed by a tripod.

If the anchors is deployed in an office or somewhere with people/furniture, it is

recommended that the anchor is installed higher than 1.8 meters above the ground and higher than the movement plane of the tag module. Higher the anchors installed, the anti-occlusion ability is stronger and the positioning accuracy and stability are higher. the recommended installation height is 2.5 meters.

If the anchor is deployed in a two-dimensional scene without any occlusion (such as the positioning of UAV and UGV), the anchors don't need to be higher than tag modules. The anchors should be deployed on the same height and the height is better bigger than 0.5 meters to avoid ground reflection interference.

The tag module should be installed in a rectangular area s of 4 anchors (or a triangular area of 3 anchors). The antenna of tag module should be perpendicular to the ground. In case of hand-held test, the tag module should be raised as high as possible to avoid blocking interference.

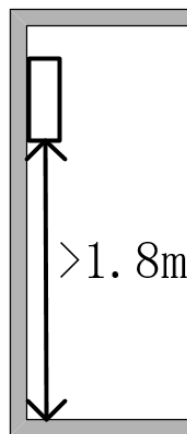

Figure 5-12 Installation Height of Anchors

Installation notice:

- 1) In two-dimensional positioning system, the aspect ration of the rectangle formed by 4 anchors shouldnot exceed 2:1;
- 2) The distance between two nearby anchors should be at least 2 meters;
- 3) All anchors should be installed on the same height to make each 4 anchors locating



in a plane;

- 4) The antenna of anchors should point to the ranging rectangle.
- 5) The anchor can not be installed on the ground, because the reflection of the ground will increase the ranging error.
- 6) Anchors should be installed as high as possible to avoid blocking interference.
- 7) There should be no metal around the antenna of anchors, please try to keep the space as empty as possible.

5.4 Driver installation

5.4.1 CH340 Driver

CH340 Driver 适用于 ULM1、ULM3、LD150(-I)模块，不适用 ULA1 模块

下载地址：<http://rtls1.haorutech.com/download/software/CH341SER.EXE>，双击 CH341SER.EXE 进行驱动安装，保持默认设置，点击安装按钮，按提示安装即可。

Run CH341SER.EXE to install and leave the settings as default. Then please click “INSTALL”, and follow the instruction to complete the installation.

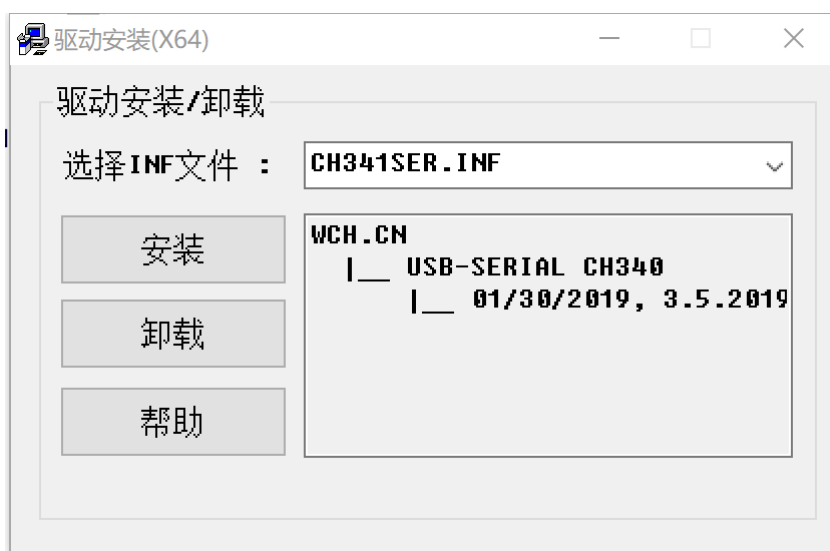

Figure 5-13 Serial Port Driver Installation

5.4.2 CP2102 Driver

CP2102 Driver 只适用于 ULA1，不适用于 ULM1、ULM3、LD150(-I)模块，



下载地址:

http://rtls1.haorutech.com/download/software/CP210x_Universal_Windows_Driver.zip

解压后，根据操作系统，Run CP210xVCPInstaller_x64.exe or CP210xVCPInstaller_x86.exe to install and leave the settings as default. Then please click “next”, and follow the instruction to complete the installation.

5.4.3 串口数据接收

After the driver is installed, connect the anchors or tags to the computer, and open the device manager of computer to check if the serial port driver is installed properly and serial port device is identified. Rememeber the serial port number of the CH340. For example, as shown in the following figure, the driver is installed properly and the serial port device is identified and the serial port number is COM5.

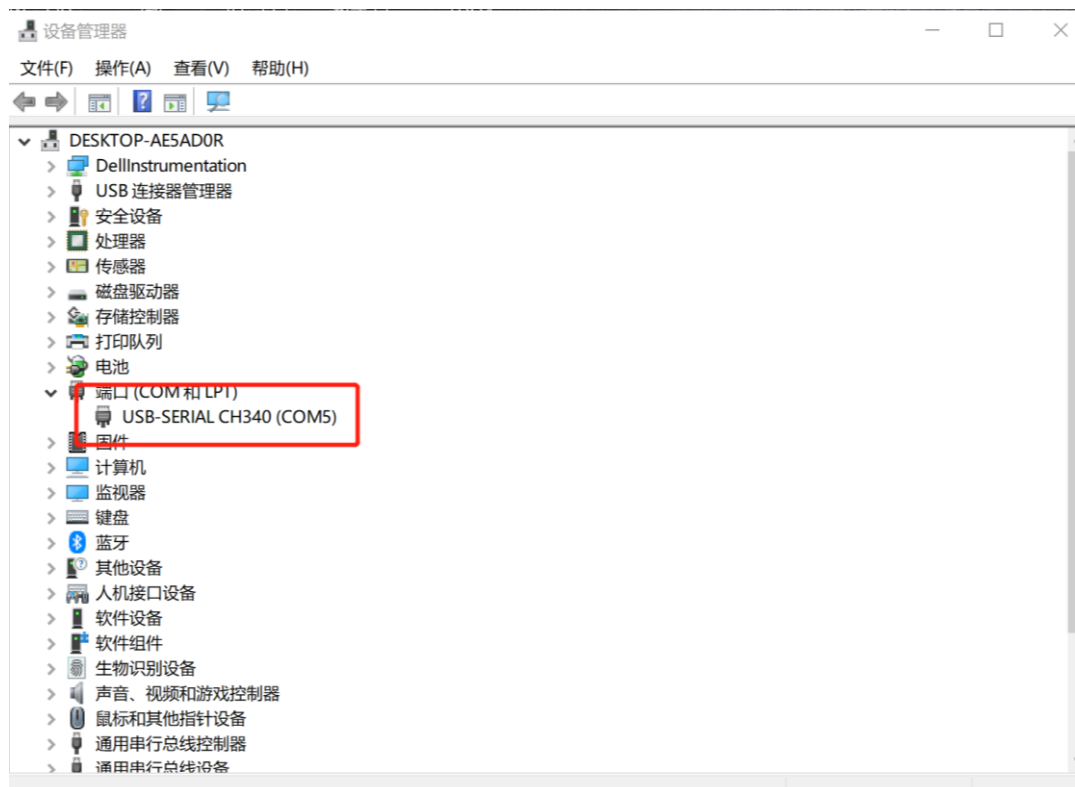

Figure 5-14 Serial Port is Identified in Device Manager

Run sscm32E.exe (serial port debugging assistant), 串口助手下载链接:

<http://rtls1.haorutech.com/download/software/sscom32E.exe> select the identified



serial port number and set baud rate to 115200, then click to open the serial port.

If the anchor is connected to PC, turn on another tag module. If the tag module is connected to PC, turn on another anchor. Make sure that there are at least one pair of anchor and tag completing communicating successfully. If there are strings begin from “mc” shown in the message box, the serial port data communication is successful and the module is connected to PC successfully.

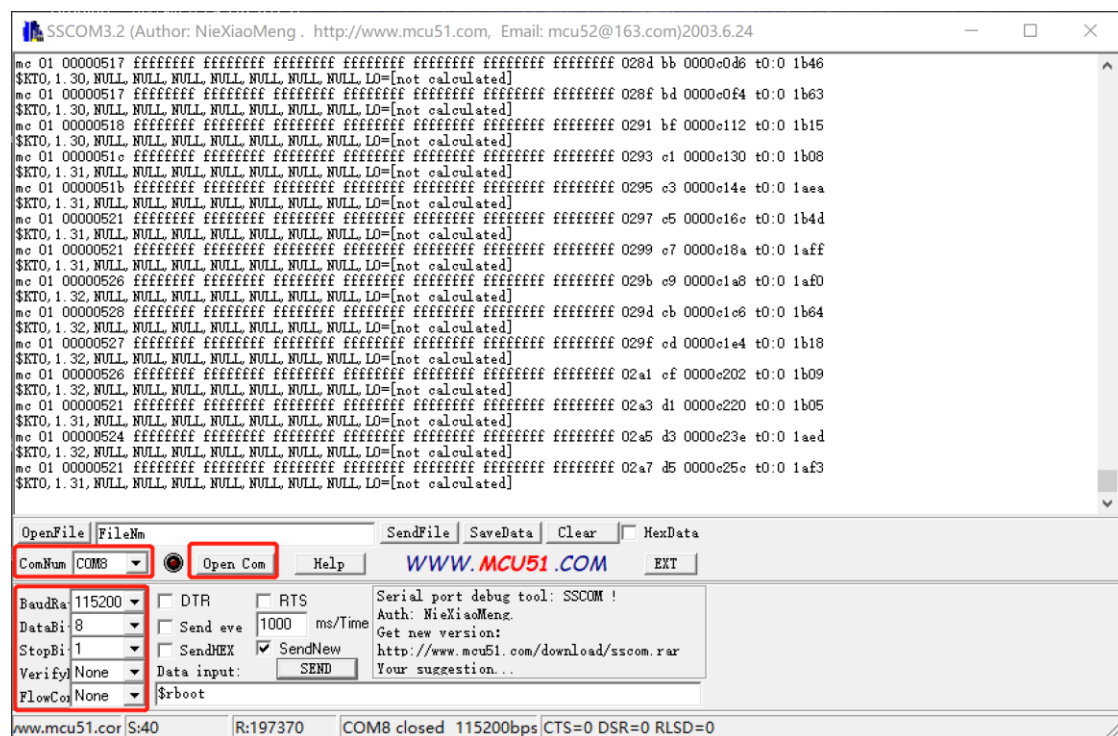

Figure 5-15 Serial Port Data Displayed on Serial Port Assistant

5.5 PC software connection

PC software 下载地址：http://rtls1.haorutech.com/download/software/HR-RTLS1_PC.zip

Unzip file “HR-RTLS1_PC.zip” and run “HR-RTLS_EN.exe”.

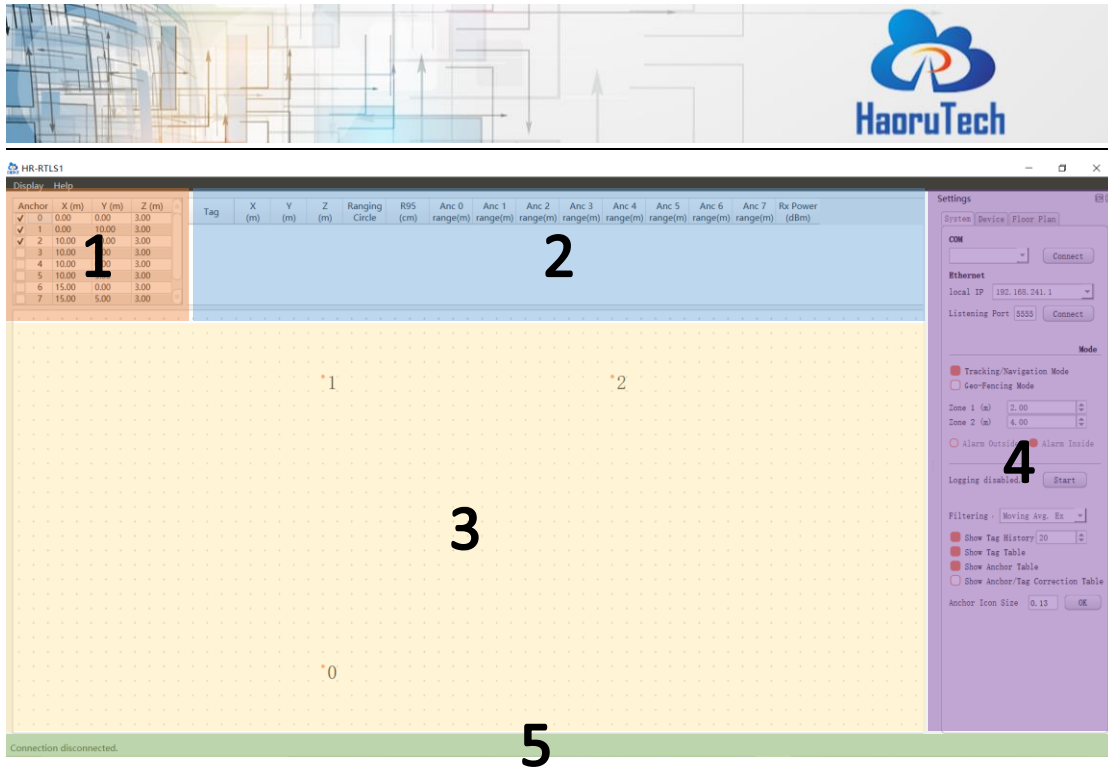

Figure 5-16 PC Software Operation Interface

As shown in Figure 5-15, the PC software interface is mainly divided into five areas: Anchor list, tag list, real-time path drawing, parameter setting and connection status.

Table 5-2 Functions of Different Zones

Zone	Name	Main Function
	Anchor list	Set the anchor coordinates and display the anchor graphic points
2	Tag list	Display tag ID , ranging distance to different anchors, and tag coordinates
3	Real-time tracking mapping	Display real-time tag module movement, also the base map can be loaded
4	Parameter settings	Settings of serial port connection, base map and grid
5	Connection status	Display data connection status and connecting module role & ID.



After the driver program is correctly installed and the UWB is connected to the computer, the corresponding serial port number will be shown in the drop-down list of “COM” in the “System” column. Select the serial port number and click the “Connect” button to connect the serial port.

If “Open error” is displayed in “Connection status” column after you click “Connect” button, please check if the serial port is occupied by other softwares (such as the Serial Port Assistant). If there is another software using that serial port, shut it down, and click “Connect” button again.

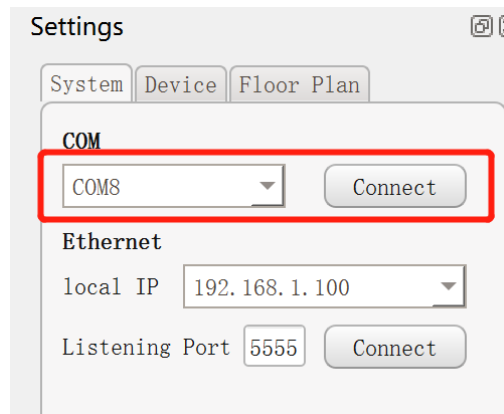

Figure 5-16 PC Software Connects to Serial Port

Make sure there are at least one anchor and one tag module are powered on, then the tag ranging result will be displayed in “Tag list”. Data in Anc 0-7 column shows the distance between the current tag and each anchor (Anc 0-7). It varies according to the number of Anchors powered on.

Tag	X (m)	Y (m)	Z (m)	Ranging Circle	R95 (cm)	Anc 0 range(m)	Anc 1 range(m)	Anc 2 range(m)	Anc 3 range(m)	Anc 4 range(m)	Anc 5 range(m)	Anc 6 range(m)
1 <input type="checkbox"/> Tag 0				<input type="checkbox"/>	<input type="checkbox"/>	0.08	13.14	2.60	0.80	-	-	-

Figure 5-17 PC Software Tag List



5.6 PC Software Positioning Parameter Configuration

After anchors is deployed according to Section 5.3, the anchor coordinates should be accurately calculated and the PC software should be correctly configured to complete accurate tag positioning.

Generally, anchor A0 is established to be point (0,0) of the coordinate system. Then measure the relative distance between A1, A2, A3 and A0 to calculate the plane (x,y) coordinates of other anchors. The height of the four anchors is the same, so the Z-axis value is the height of anchors above the ground. After calculating the coordinates of all anchors, fill them in the "Anchor List" column in PC software.

In example Figure 6-21, the distance between A0 and A1 is 3.3 meters, and the distance between A0 and A3 is 3 meters. 4 anchors make a standard rectangle which is 2 meters above the ground. Then we get the coordinates of the 4 anchors: A0(0,0,2), A1(0,3.3,2) A2(3,3.3,2), A3(3,0,2).

After accurate positioning and correctly inputting the anchor coordinates, the coordinates of the tag (x,y,z) can be shown in the "tag list" area, and the tag positioning graphic point and trace can be shown in the "real-time trace drawing" area.

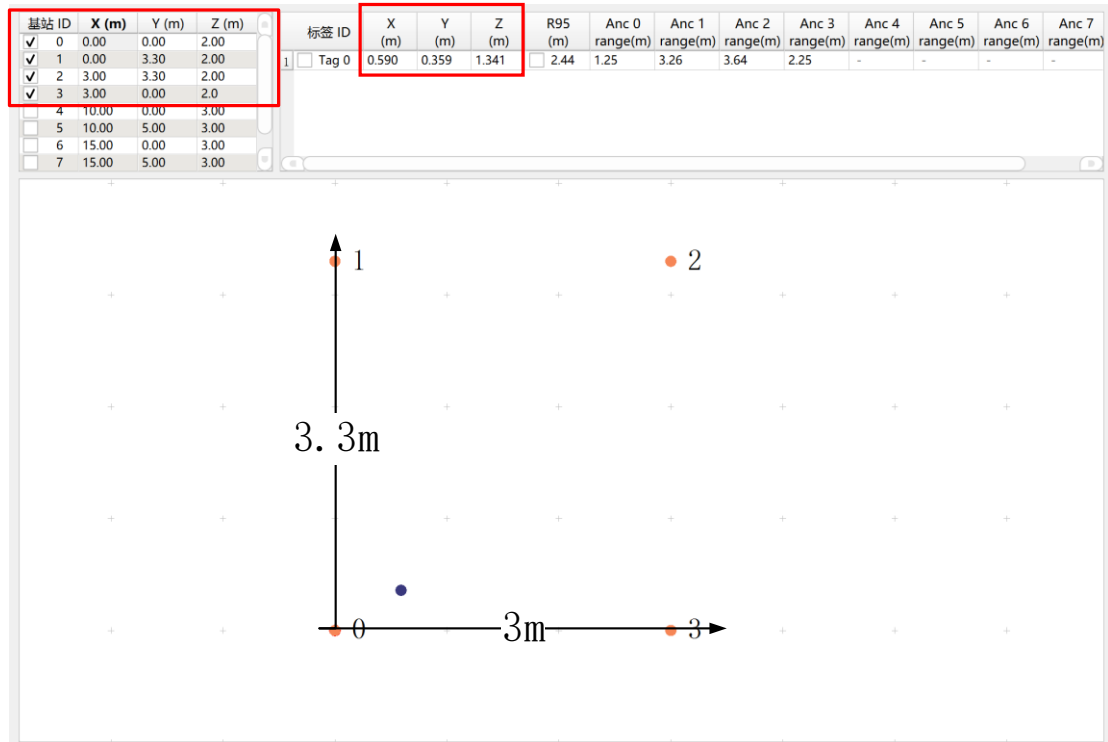

Figure 5-18 Anchor Coordinates Configuration in PC Software

Notice:

- 1) During the anchor deployment, there is no fixed standard for the installation sequence of anchors. The only important thing is to calculate the anchor coordinates accurately.
- 2) Anchor coordinates can be set in the first quadrant or other quadrants, there is no fixed rules.
- 3) The origin of the coordinate system (0,0) doesn't have to be A0. It can be set with any anchors, as long as the relative distance between other anchors is accurately calculated. The accuracy of tag positioning coordinates is based on the accuracy of the origin(0,0) coordinates.

5.7 PC software base map configuration

The PC software can load background image in 'png' format as a "base map" of positioning trace (not necessary for positioning, commonly used for analysing).

The principle of setting the base map:

The base map can be adjusted to match well-setting anchor icon, rather than adjusting the anchor icon position to match the base map. We can use Visio or other architectural drawing software to create a base map. Before loading the base map, try to set the anchor coordinates and display the anchor icon on the white background image according to the actual scale. Click the “Parameter Settings - Floor Plan”, click “Open” button to select the png image to be uploaded.

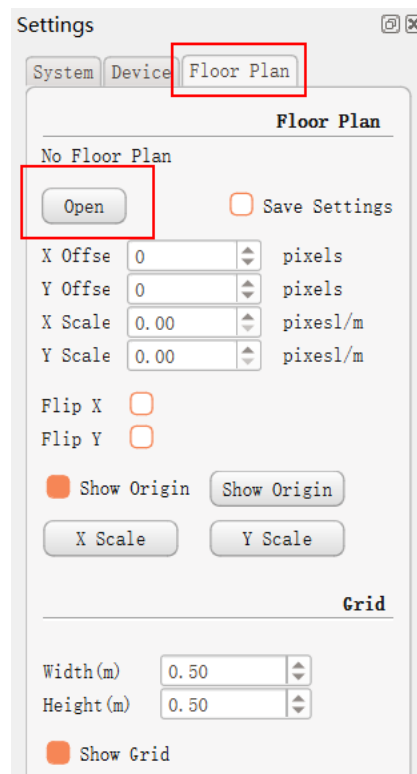

Figure 5-18 Base Map Configuration

After loading the image, it will appear relatively large on the whole interface. Firstly, adjust the ratio of "X scale" and "Y scale" to reduce the ratio of the image to adjust it to the real scale of the actual anchor icon .

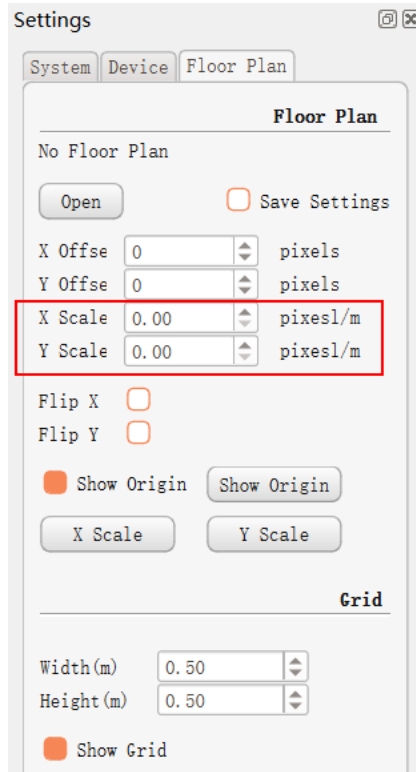

Figure 5-20 X/Y Scale Configuration

Adjust the “Flip X” or “Flip Y” to make the image match the actual orientation.

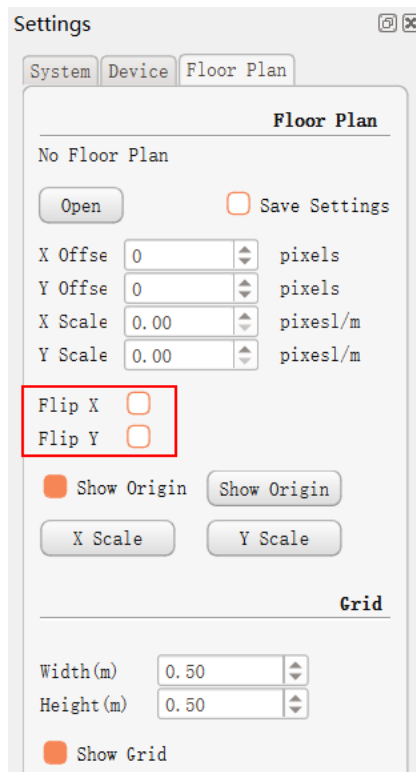

Figure 5-19 Flip X/Y Configuration



Click "Show Origin" button, and click the origin point of the base map. After the setting is complete, fine-tune "X scale" and "Y scale" to make the base map completely match the anchor icon. Then base map setting is done.

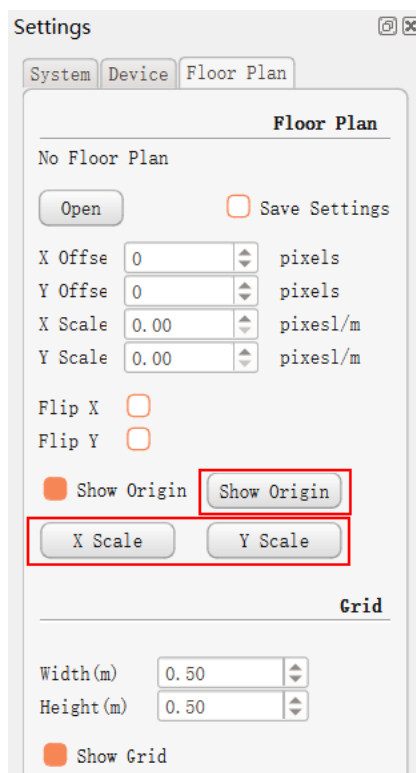

Figure 5-2 Set Origin Point

6 Mobile phone application settings(developing)

RTLS1 modules support connecting to Android phone for data display and tag module trace display. Users can debug without connecting to a computer when establishing and testing the system. Currently, we only support tag modules to connect to APP.

Tag module can be connected to the mobile phone by OTG connector, Type-C port and data transmission cable. Open the directory "HR-RTLS1 Testing\Mobile phone positioning APP" and transfer the .APK installation file to the Android mobile phone and install the APP.



Figure 6-1 RTLS1 Module Connects to Android Phone

After the UWB module is connected to the mobile phone, it can be powered by the mobile phone. For some mobile phone models, you need to search for "OTG" option in the system settings and enable the OTG output function. After the module is powered on, open the APP and click the "connect" button in the upper right corner to connect the UWB module. Then the ranging information of the tag can be displayed. Click the LOGO drop-down options in the upper left corner to set the coordinates of the anchors. After setting coordinates of the anchors correctly, the tag position can be calculated and displayed. The configuration of the anchor module coordinates on mobile phone is the same as it on PC.



Figure 6-2 Android Phone Positioning Application



7 Communication protocol

7.1 Uplink data protocol

The uplink data protocol is the data uploaded actively by the UWB module through the serial port.

Serial communication baud rate: 115200bps-8-n-1

Serial communication data example:

```
mc Of 00000663 000005a3 00000512 000004cb ffffffff ffffffff ffffffff ffffffff 095f c1  
00146fb7 a0:0 22be
```



Table 7-1 Serial Communication Protocol Description

Content	Example	Description
HEAD	mc	Head of the data packet, fixed: "mc"
MASK	0f	If ranging results are valid. For example: mask=0x07(0000 0111) means RANGE 0,1,2 are valid.
RANGE0	00000663	Distance from tag to anchor A0, hexadecimal notation, unit: mm, result of the example is 1.635m.
RANGE1	000005a3	Distance from tag to anchor A1
RANGE2	00000512	Distance from tag to anchor A2
RANGE3	000004cb	Distance from tag to anchor A3
RANGE4*	ffffff	Distance from tag to anchor A4 (Invalid ranging or no anchor)
RANGE5*	ffffff	Distance from tag to anchor A5 (Invalid ranging or no anchor)
RANGE6*	ffffff	Distance from tag to anchor A6 (Invalid ranging or no anchor)
RANGE7*	ffffff	Distance from tag to anchor A7 (Invalid ranging or no anchor)
NRANGES	095f	message flow, accumulated, 0x0-0xffff
RSEQ	c1	Range number, accumulated, 0x0-0xff
RANGTIME	00146fb7	Ranging timestamp, timestamp of MCU, unit: ms
rIDt:IDa	a0:0	r means the role: a-anchor, t-tag; IDt-tag address, IDa-anchor address
DIAGNOSIS	22be	Only existing when the role is anchor, and default is RX_POWER(current anchor and last communicated tag)=-88.94dBm
END	\r\n	End of the data packet



***tips:** Users can only get data from RANGE4/ RANGE5/ RANGE6/ RANGE7 when the firmware program works as 8 anchors, and nothing will output when it is a 4 anchors firmware program.

If the current device is a tag, the ranging and positioning information will closely follow “mc...”;

Example: \$KT0, 1.69, 2.93, 4.98, NULL, LO = [-2.45, 5.44, 1.43]

Description:

Current role-T0;

K- Kalman filtering is enabled;

NK- Kalman filtering is not enabled;

Distance to anchor A0 is 1.69m;

Distance to anchor A1 is 2.93m;

Distance to anchor A2 is 4.98m;

Distance to anchor A3 fails to range, or A3 does not exist or A3 is not turned on.

The real-time positioning coordinates of the tag locates in the brackets after LO, and the coordinates is calculated within the tag. Users should note that the calculation can be completed only after the anchor coordinates are configured to the tag successfully.

8 Secondary Development

8.1 Embedded Software Development

HR-RTLS1 takes STM32F103CBT6 series (or fully compatible alternative chip made in China) as the main control MCU. The wearable devices take STM32L151CUB6 low-power microcontroller, which is controlled by CUBEmx tool, developed by HAL library and KEIL-MDK integrated development environment.

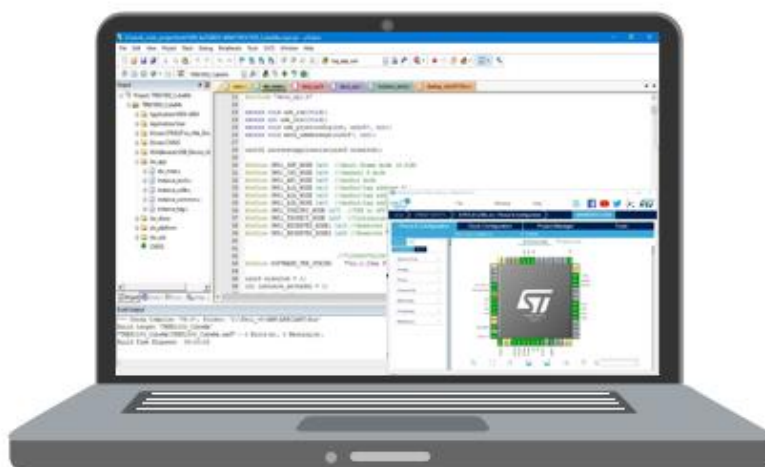

Figure 8-1 Embedded Software Development environment diagram

Figure 8-1 shows the embedded software architecture: It is mainly divided into driver layer, DW API layer and application layer.

The driver layer is mainly used for the SPI communication between STM32 and DWIC. Generally, we use CUBEmx for initial configuration and HAL library for development. After the initialization, the initialization code is automatically generated. It uses SPI data to send and receive function to connect to DW_API layer for completing the establishment of driver layer. In addition, the configuration of break, IIC, serial port, watchdog is initialized in CUBEmx configuration. Users only need to learn the CUBEmx configuration, rather than coding in the driver layer.

DW API layer uses DecaWave official API for migration and establishment. API will encapsulate common functions. The main functions of DWIC are basically implemented by reading and writing the corresponding registers. You can learn the common API features through the official API examples and “DW1000_Software_API_Guide.pdf”. There is less coding work in DW_API layer, and it’s enough for you to call it when developing the corresponding application layer



function. The main program directory is “Src\decadriver, Src\platform”.

The application layer implements the main function of TWR ranging. Functions like system status reading, parameter configuration, sending/receiving of TWR data, TOF calculation, Kalman filter, serial port data transmission, OLED display, etc are all accomplished by it. The application layer is totally developed by HaoruTech. It is the core code of the system, so try to get familiar with it.

The secondary development is based on the application layer. The main program directory is “Src\application, Src\kalmanfilter, Src\OLED”.

Name	Main files	Main functions
Application layer	dw_main.c instance_anchor.c instance_tag.c	TWR communication with multi-anchors and multi-tags TOF calculation/OLED display/ Kalman filtering/serial port data output/trilateral positioning algorithm, etc
DW_API layer	deca_device.c port.c deca_spi.c	Official API library Configuring parameters and receiving&sending data by reading and writing the corresponding registers Encapsulate common functions for easy using
Driver layer	STM32F1xx_HAL_Driver spi.c i2c.c	Configuration of SPI, GPIO, CLOCK, break, IIC, serial port, watchdog Generate initialization code by CUBEmx

Table 8-1 Overall Architecture of Embedded Software

8.2 PC Software Development

PC software takes C++ QT as the software architecture. Source code, <PC QT Development Quick Start Manual>, development environment installation packages are provided to reduce the difficulty of secondary development.



The PC software can be full screen displayed, and adapted to 1080P/2K/4K and other resolutions screen.

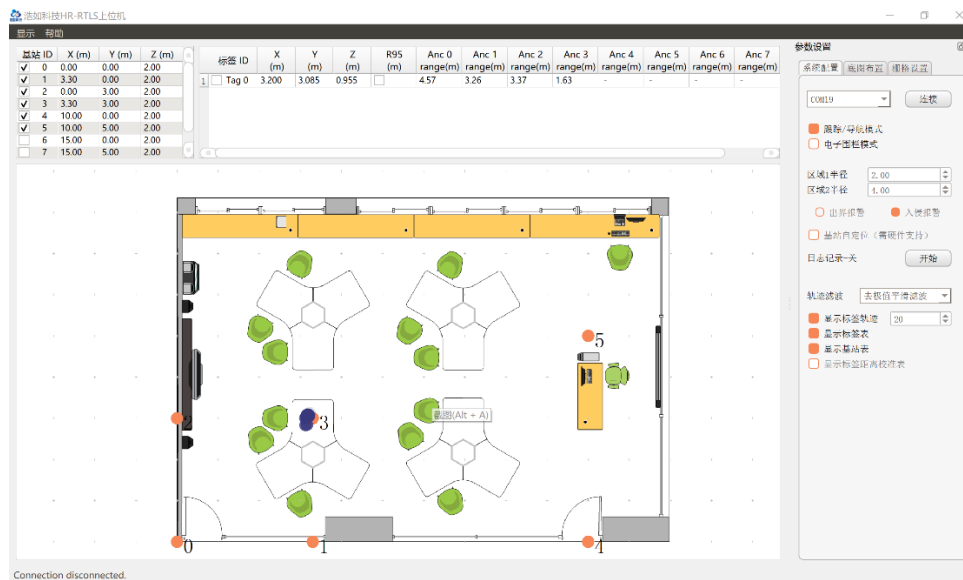

Figure 8-2 PC Software

8.2.1 PC Software main functions

- 1) Different modes: navigation mode, tracking/following mode, single anchor fence mode
- 2) Saving & recording logs.
- 3) Map import/match/ranging
- 4) Real-Time trace display, history trace recording, and playback analysis.
- 5) Analysis of positioning accuracy and positioning timestamp
- 6) Optional average smoothing filter and de-extremum average smoothing filter
- 7) Grid adjustment, zoom ratio adjustment, etc
- 8) Control unit enable/disable, full screen display, high-resolution adaption configuration.

8.2.2 Historical Trace 2D/3D Analysis

A historical trace analysis is provided to generate 2D/3D views of historical trace, which is convenient for users to observe and analyze historical trace visually.

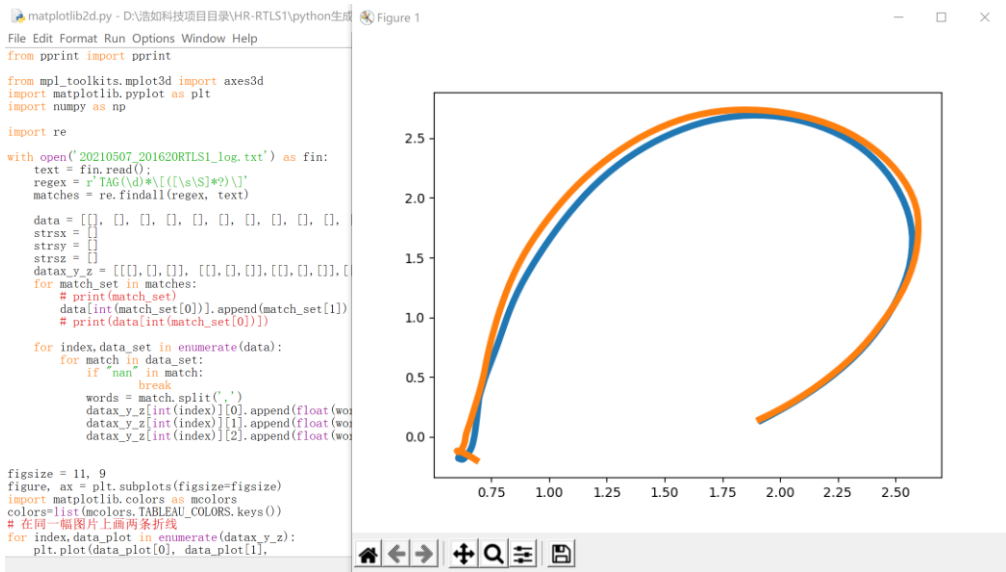

Figure 8-3 Historical Trace of 2D Analysis

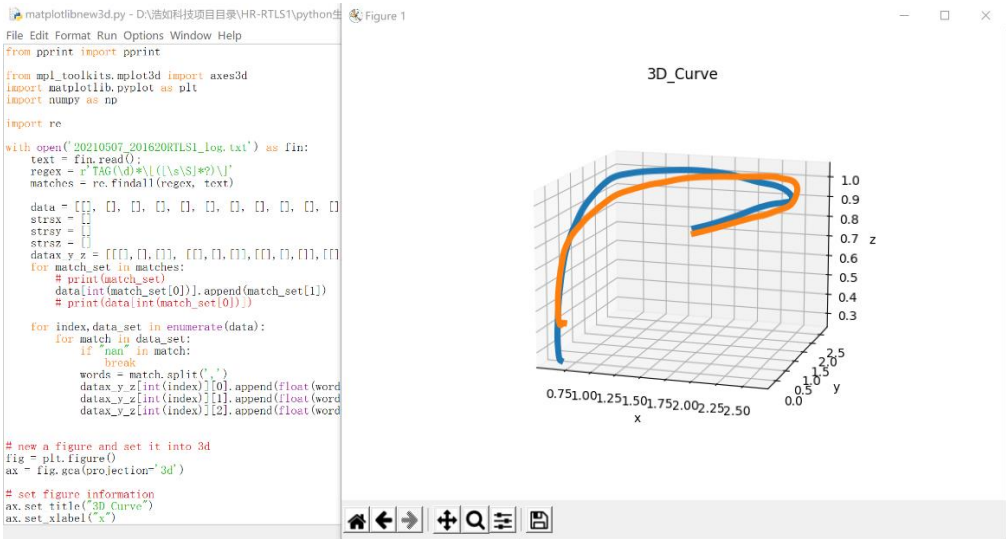

Figure 8-4 Historical Trace of 3D Analysis

How to build PC development environment: <https://b23.tv/ZOGzdFF>

Data recording with historical trace playback video: <https://b23.tv/S9T5lpg>

8.3 Hardware Design

We provide the hardware schematic diagram of modules. Its convenient for users to study the hardware principle and secondary development.

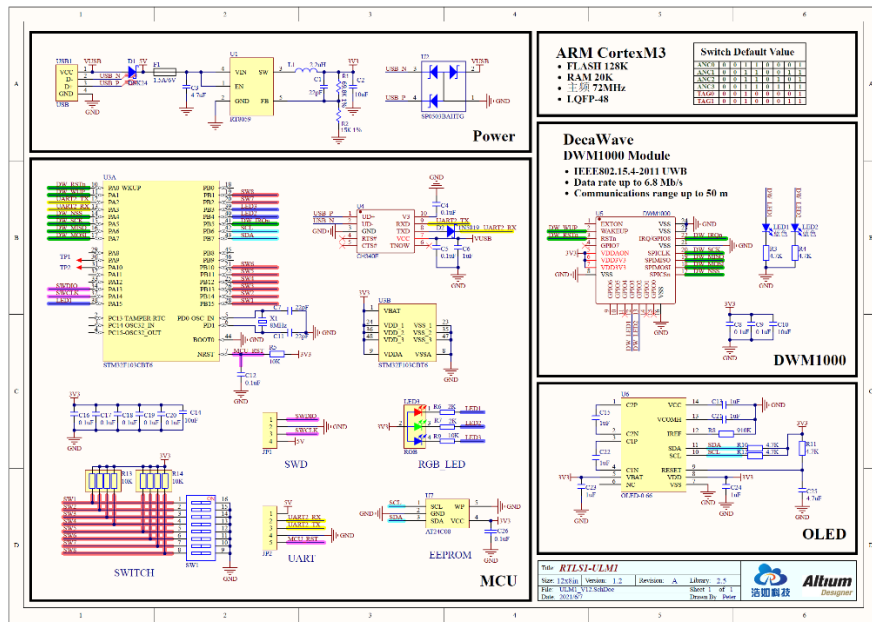

Figure 8-5 Hardware Schematic Diagram

9 Gateway Module

All the RTLS1 series modules can cooperate with the gateway module to achieve Ethernet data communication. After connecting RTLS1 modules to the gateway module with USB cable, users need to configure the host IP and port information, then the Ethernet data communication can be completed.

Table 9-1 Gateway Module Type

Type	Function	Protocol
RTLS1-GW1	wifi eth(RJ45)	TCP_Client(by default) TCP_Server UDP
RTLS1-GW2	wifi eth(RJ45) POE	

How to use Gateway Module: <https://b23.tv/D8YBsho>

10 FAQ

1. Is the system open source?

The system is completely open sourced, including embedded code, upper



computer code, algorithm and etc. Besides, it provides related development manuals and video tutorials, which helps the user to begin secondary development easily.

2. Is the system mature? Does it need redeveloping before use?

The system is already mature, it provides complete positioning function, which means the user can get positioning data through ports directly. Also, users can redevelop the system to meet their own needs through editing source code.

3. How many modules do I need?

It depends. Here are some examples:

- 1) If you need to range from one to one, it needs two.
- 2) If you need to set up 2D position, it needs 4, which includes 3 anchors and 1 tag.
- 3) If you need to set up 3D position, it needs 5 at least, which includes 4 anchors and 1 tag.
- 4) If you already had modules in hand and want to increase the number of anchors or tags, you need to buy related numbers of the missing modules.
- 5) If you need to position 10 tags, then you need to get 4 anchors and 10 tags, which results in 14 modules.

We recommend buying 5 modules at least, for the following reasons:

- 1) 4 anchors positioning can cover two times the area than 3 anchors positioning.
- 2) There always some communication failure during the testing; for 4 anchors positioning method, it will finish the positioning by 3 anchors data out of 4, but for 3 anchors positioning method, it needs to finish the positioning by all 3 anchors data, which leads to reduce the success rate.
- 3) Also, 4 anchors & 1 tag can be reset to 3 anchors & 2 tags as well.



4. What is the positioning accuracy? Is the accuracy related to the area?
For XY positioning, the accuracy is 10cm (CEP95); for Z direction, the accuracy is 30cm (CEP95). There is no direct relationship between usage area and accuracy. There is no reducing accuracy when increase the usage area. But it should be noted that for the large power needed for ULM1-LD600, it will have an obvious multipath effect when use in 5*5cm area, so we recommend using it in a larger area.
5. Does the module have shell? Is it waterproof?
ULM1 does not have shell, LD150/LD600 have shell and external antenna. But the shell is not either sealed or waterproof.
6. How long is the battery standby time?
It depends on the external power supply capacity and emission frequency. For ULM1 equipped with matching power supply, the anchor standby time is approx. 10 hours, and the tag standby time is approx. 12 hours.
7. What the difference between RTLS1, RTLS2, RTLS3?
RTLS1, RTLS2, RTLS3 are the third generation UWB positioning product that developed by our company.
 - 1) RTLS1 is based on the STM32 platform development kit, open source and available by two types:50m and 600m. It is suit for study assessment, study UWB underlying drive method, product source code migration, system integration and etc.
 - 2) RTLS2 is productized equipment, closed source, communicate by ethernet, WEB interface. It is suit for application directly in the project.
 - 3) RTLS3 is based on Arduino platform development kit, open source, the underlying drive is encapsulated and easy to redevelop. It is suit for study assessment, development research, project study in college, system integration and etc.
8. What is the update frequency for the tag?



The default frequency is 112ms, it can set to 10ms(6.8MHz) for minimum duration through modify the firmware parameter.

9. How does the module connect with PC?

The module uses USB port to connect with PC. It only requires one out of 4 anchors to connect with PC.

10. How does the module connect with the other embedded devices?

The module uses UART-TTL port onboard to connect with the other embedded devices.

11. Do I need to buy other accessories after purchasing the system?

The system provides matched portable power source and data cable. If the user needs to use it in the open air and need better stability and accuracy, we recommend buying tripods to hold the anchors. The height of the tripods had better not exceed 3m.

12. Is the modular suit for the drone or AGV?

There is no problem to use it for drone or AGV. Until now many customers use it in this way and get good feedback.

13. Is it easy to use?

It is easy to build up the system with the help of video tutorial. It is also easy for redeveloping the system using development manual if the user has background knowledge of embedded development.

14. When can I get the full set of technical data?

After purchasing, the user will need to build up the system and finish testing according to the information in the package first to make sure the function will meet his need. If the product suit for the user, after confirming the payment, our customer service will send all the technical data to the user. If the product does not meet the user's need, he can return the product and get refund without damage the appearance of the product. The product will not be returned after the user receives the technical data.



15. How will the obstructions affect the positioning?
- 1) Wall: LD600 can pass through 1 solid wall, but error will increase about 30cm, depends on the material and thickness of the wall. ULM1, ULM3 cannot pass-through walls.
 - 2) Wire pole, trees, and other long and narrow objects: Depends on the distance between tags and anchors. For example, if the distance between the tag and anchor is 60m, the obstruction will play little role on the result accuracy. But if the distance between the tag and anchor is only 1 m, It will affect the result in a large part.
 - 3) Glass: Glass will affect the accuracy of UWB positioning in a large part.
 - 4) Steel, iron and other metal: Metal will absorb electromagnetic wave from the UWB, especially when it is closed to the modular. It will block signal and lead to no result.
 - 5) Paperboard and wood board: it will not affect the result much if the thickness is about 10cm, but the signal will get reduction.
16. What is the probable reason for the low accuracy of the result.
- 1) Check whether the anchor coordinate on the upper computer software is correct.
 - 2) Check whether the anchor height is above 1.8m.
 - 3) Check if any signal of the anchors is too weak, then try to move the anchor to get better signal.
 - 4) Check if there are any obstructions between the modular.
 - 5) Check all the anchors are in the same plane (if the project requires).
 - 6) Check if any tag is too far from all the anchors.
17. Why it says too close between the anchor and the tag?
- 1) In the situation of long-distance communication, we recommend to use tripods to hold the anchors and tags, and also keep the height above



1.8m during the testing.

- 2) Check if there is obstructions or strong electromagnetic interference around.
- 3) Check if antenna is installed in the right way.