

GPIO0	1	GPIO0	40	VBUS
GPIO1	2	GPIO1	39	VSYS
GND	3	GND	38	GND
LoRa_BUSY	4	GPIO2	37	3V3_EN
LoRa_CS	5	GPIO3	36	Pico_3V3
GPIO4	6	GPIO4	35	P35
GPIO5	7	GPIO5	34	GPIO28
GND	8	GND	33	GND
GPIO6	9	GPIO6	32	GPIO27
GPIO7	10	GPIO7	31	BATTERY_AD
GPIO8	11	GPIO8	30	RUN
GPIO9	12	GPIO8	29	LoRa_ANT
GND	13	GND	28	GND
CLK	14	GPIO10	27	GPIO21
MOSI	15	GPIO11	26	DIO1
MISO	16	GPIO12	25	GPIO19
GPIO13	17	GPIO13	24	GPIO18
GND	18	GND	23	GND
GPIO14	19	GPIO14	22	GPIO17
LoRa_RESET	20	GPIO15	21	GPIO16

Pi pico (40P)

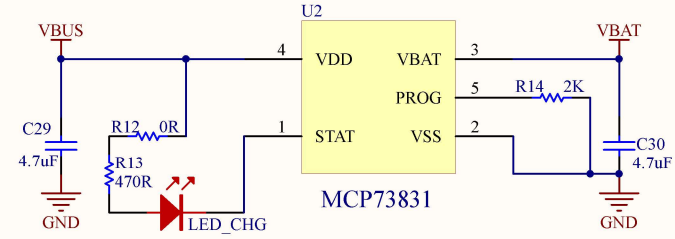

Pico-LoRa-SX126X

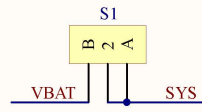
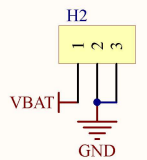
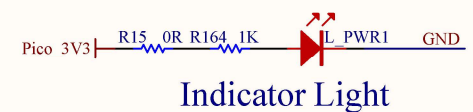

Indicator Light

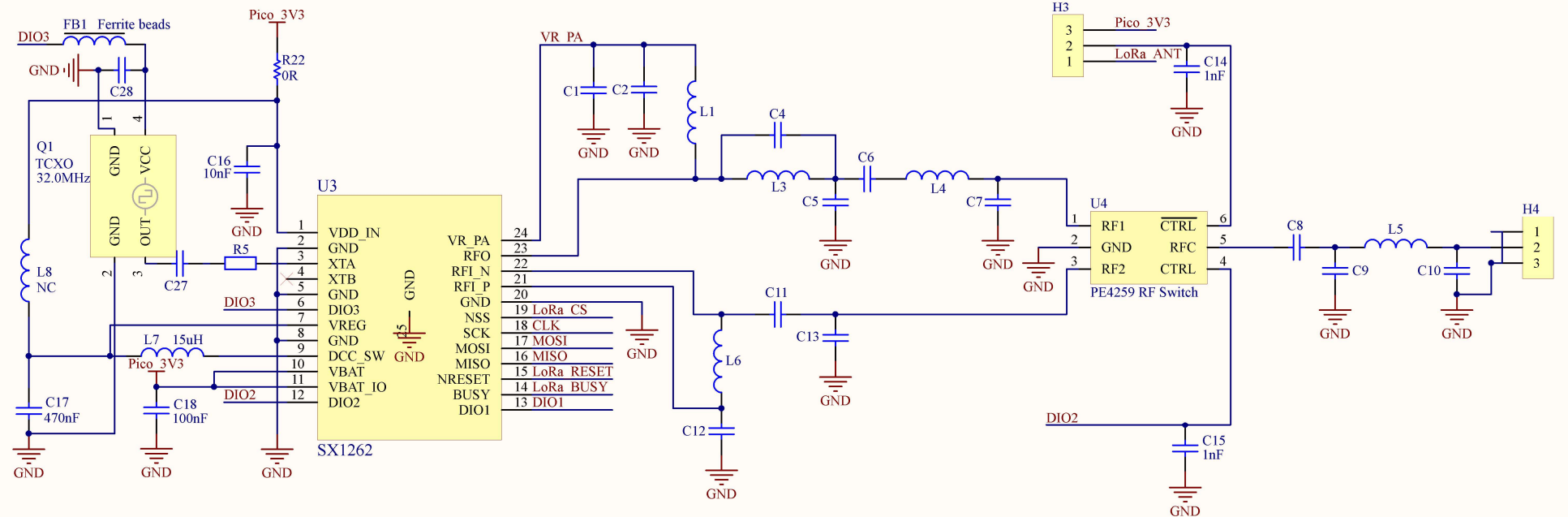
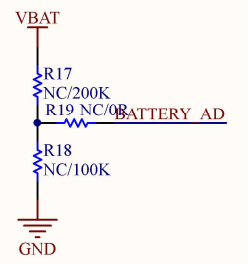

VDD_IN	1	VR_PA	24
GND	2	RFO	23
XTA	3	RFI_N	22
XTB	4	RFI_P	21
GND	5	GND	20
DIO3	6	19 LoRa_CS	19
DIO3	7	18 CLK	18
VREG	8	17 MOSI	17
GND	9	16 MISO	16
DCC_SW	10	15 LoRa_RESET	15
VBAT	11	14 LoRa_BUSY	14
VBAT_IO	12	13 DIO1	13
DIO2			

SX1262

U1

PWR1 CHG

PWR1 G1G

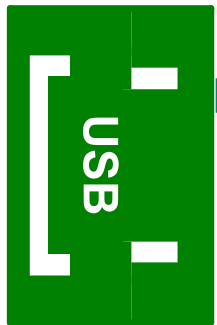

USB

