

System Power

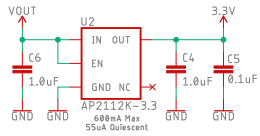

RTC Backup

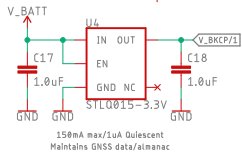

Wheel Tick and Direction Signal

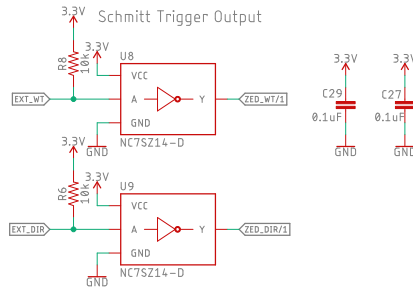

LiPo Charger @ 1A

Use with >1Ahr 3.7V Battery

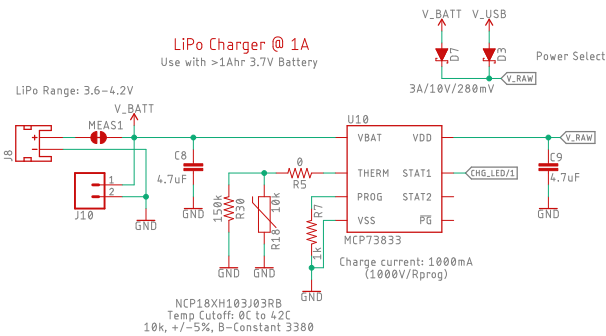

Fuel Gauge

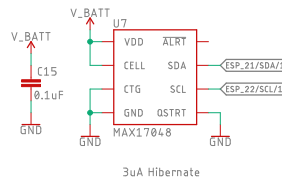

Soft Power Switch

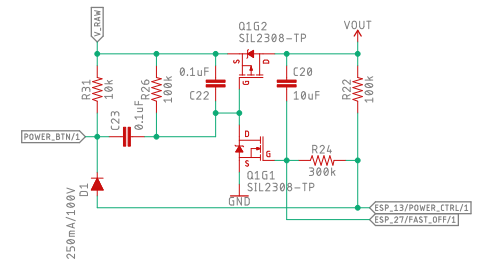

Data Port Selection

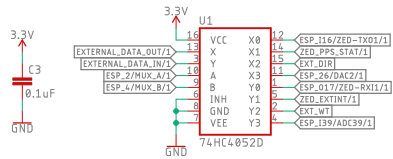

All input signals must be limited to 3.3V

LIS2DH12 / Accelerometer

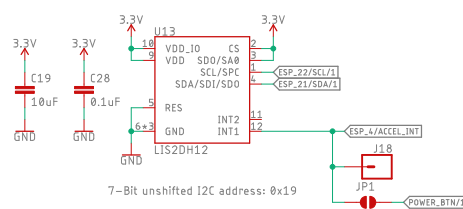

Released under the Creative Commons Attribution Share-Alike 4.0 License <https://creativecommons.org/licenses/by-sa/4.0/>

TITLE: SparkFun RTK Express Plus

Design by: N. Seidle

REV: v11

Date: 9/29/2021 12:05 PM

Sheet: 2/2