



- Open loop or closed loop speed control operation
- Closed loop position control with encoder, hall sensors, analog or pulse/frequency feedback
- Precise speed and position control when Encoder feedback is used
- Torque mode
- PID control loop
- Configurable Data Logging of operating parameters on Serial Output for telemetry or analysis
- Built-in Battery Voltage and Temperature sensors
- Regulated 5V output for powering Encoders, RC radio, RF Modem or microcomputer
- Programmable acceleration and deceleration
- Programmable maximum forward and reverse power
- Ultra-efficient 0.33 mOhm ON resistance MOSFETs
- Separate current sensors for Motor Amps and Battery Amps measurement
- Stall detection and selectable triggered action if Amps are outside user-selected range
- Overvoltage and Undervoltage protection
- Programmable Watchdog for automatic motor shutdown in case of command loss
- Overtemperature protection
- Diagnostic LEDs
- Efficient heat sinking using conduction bottom plate
- Dustproof and weather resistant. IP56 NEMA rating
- Power wiring via high amperage power terminals
- 5.51" (140mm) L, 7.87" (200mm) W, 2.28" (58mm) H
- -40° to +85° C operating environment
- 5.0lbs (2.3kg)
- Easy configuration, tuning and monitoring using provided PC utility
- Field upgradeable software for installing latest features via the Internet

## Orderable Product References

Reference	Number of Channels	Amps/Channel	Volts	Ethernet	Resolver
RGDC1860	1	300	60	No	No
RGDC1896	1	300	96	No	No

## Important Safety Disclaimer

**Dangerous uncontrolled motor runaway condition can occur for a number of reasons, including, but not limited to: command or feedback wiring failure, configuration error, faulty firmware, errors in user script or user program, or controller hardware failure.**

**The user must assume that such failures can occur and must make his/her system safe in all conditions. Roboteq will not be liable in case of damage or injury as a result of product misuse or failure.**

## Power Terminals Identifications and Connection

Power connections are made by means of high amperage power terminals located at the top of the controller.

Reference	Number of Channels	Amps/Channel	Volts	Ethernet	Resolver
RGDC1860	1	300	60	No	No
RGDC1896	1	300	96	No	No

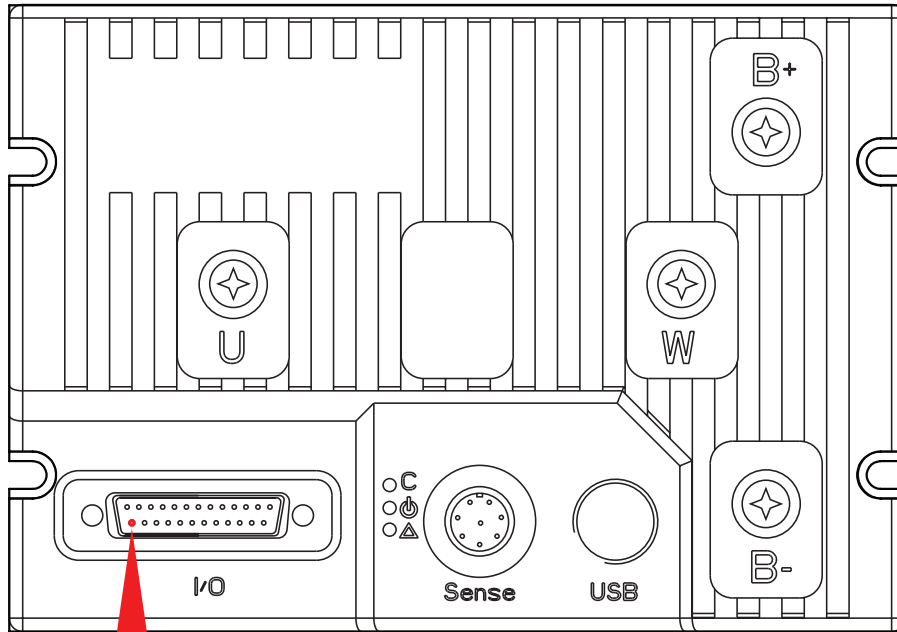

Warning: Properly identify PowerControl pin 25 before applying high voltage to it

FIGURE 1. Top Controller Layout

Figure 2, below, shows how to wire the controller and how to turn power On and Off.

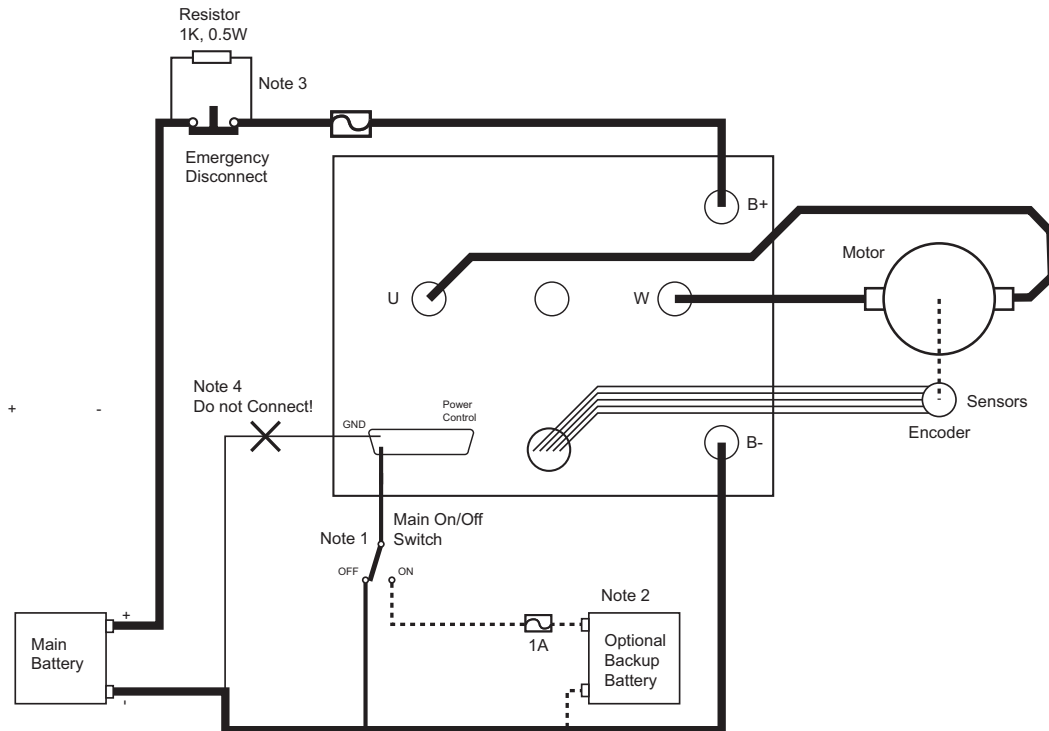

FIGURE 2. Powering the Controller. Thick lines identify **MANDATORY** connections

---

## **Important Warning**

**Carefully follow the wiring instructions provided in the Power Connection section of the User Manual. The information on this datasheet is only a summary.**

## **Mandatory Connections**

It is imperative that the controller is connected as shown Figure 2, above, in order to ensure a safe and trouble-free operation. All connections shown as thick black lines are mandatory. The controller must be powered On/Off using switch SW1 on the Power Control input.

## **Emergency Switch or Contactor**

The battery must be connected in permanence to the controller's B+ terminal via a high-power emergency switch or contactor as additional safety measure. The user must be able to deactivate the switch or contactor at any time, independently of the controller state.

## **Precautions and Optional Connections**

Note 1: The power control (pin 25 on DSUB connector) must be grounded to turn off the controller. Floating the power control or connecting it to a battery will turn on the internal logic.

Note 2: A separate power supply may be used to power the controller's internal logic to keep the controller alive in case of voltage drop at the main battery because of motor load. **Voltage on Power Control pin must not exceed 50V Max. Make sure you correctly identified pin 25 before applying voltage to it.**

Note 3: Use precharge 1K, 0.5W Resistor to prevent switch arcing.

Note 4: Beware not to create a path from the ground pins on the I/O connector and the battery minus terminal.

---

## **Controller Mounting**

During motor operation, the controller will generate heat that must be dissipated. The published amps rating can only be fully achieved if adequate cooling is provided. Good conduction cooling can be achieved by mounting the controller to a metallic surface, such as the chassis, cabinet, etc.

---

## **Sensor and Commands Connection**

Connection to RC Radio, Microcomputer, Potentiometer, encoders and other low current sensors and actuators is done via the 25-pin DSUB connectors and the 8-bit circular connector located at the top of the controller. The functions of many pins vary depending on controller configuration. Use mating connector Conxall/Switchcraft model 6282-8SG-3DC, or equivalent. The pin assignments are found in the Tables 1 and 2, below.

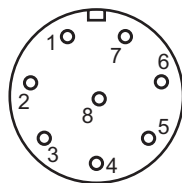

FIGURE 3. Circular Connector Pin Locations

---

TABLE 1.

Connector pin	Wire Color	Power	Ana	Encoder	DOUT	Default Configuration
1	Red	+V5				
2	White			ENC3A		Unused
3	Green			ENC3B		Unused
4	Blue		ANA11			Unused
5	Orange		ANA12			Unused
6	Brown				DOUT5	Digital output
7	Yellow				DOUT6	Digital output
8	Black	GND				

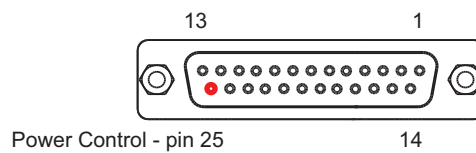

FIGURE 4. Main Connector Pin Locations

TABLE 2.

Connector Pin	Power	Dout	Com	Pulse	Ana	Dinput	Enc	Default Config
1	GND							
14	5VOut							
2			RSTxD					RS232Tx
15				Pln1	ANA1	DIN1		RCRadio1
3			RS RxD					RS232Rx
16				Pln2	ANA2	DIN2		RCRadio2
4				Pln3	ANA3	DIN3		AnaCmd1 (1)
17				Pln4	ANA4	DIN4		Unused
5	GND							
18		DOUT1						Motor Brake
6		DOUT2						Contactore
19		DOUT3						Unused
7		DOUT4						Unused
20			CANH					Unused
8			CANL					Unused
21				Pln5	ANA5	DIN5	ENC2A	Unused
9					ANA9	DIN9		Unused
22				Pln6	ANA6	DIN6	ENC2B	Unused
10					ANA10	DIN10		Unused
23			RS485+					RS485+
11			RS485-					RS485-
24				Pln7	ANA7	DIN7	ENC1A	Unused
12				Pln8	ANA8	DIN8	ENC1B	Unused
25	PwrCtrl							
13	GND							

Note 1: Analog commands are disabled in factory default configuration.

For use in environments where liquid particles or fine dust may be present, the controller's cover is shaped for DSub connectors with waterproof hoods, as shown in Figure 5. Product references EDAC 627-230-025-010, CONEC 165X14839X or Assmann A-DS25-HOOD-WP

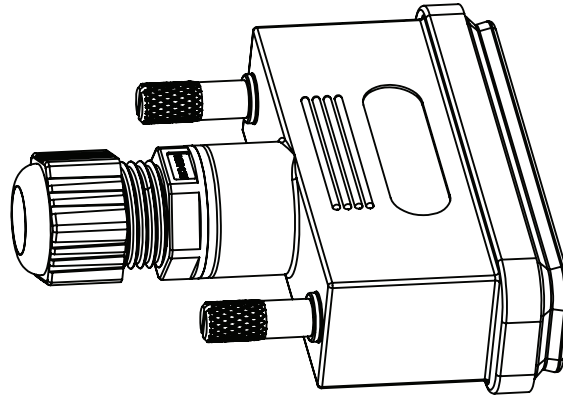

FIGURE 5. DSub Connector with Waterproof Hood

---

---

## Enabling Analog Commands

For safety reasons, the Analog command mode is disabled by default. To enable the Analog mode, use the PC utility and set Analog in Command Priority 2 or 3 (leave Serial as priority 1). Note that by default the additional securities are enabled and will prevent the motor from starting unless the potentiometer is centered, or if the voltage is below 0.25V or above 4.75V. Use the PC utility to enable and assign analog inputs.

---

## CAN Bus Operation

The controller can interface to a standard CAN Bus network, using 4 possible protocols: Standard CANOpen, a simple and efficient meshed networking scheme (RoboCAN), and two simplified proprietary schemes (Mini-CAN and RawCAN). Please refer to the User Manual for details.

---

## Serial Communication

The controller has a full RS232 compatible serial interface. The serial port can easily be connected to devices with TTL serial using a simple resistor and diodes circuit. See user manual for details.

The controller is equipped with three LED indicator lights, as shown in Figure 6:



-  Communication LED
-  Power LED
-  Status LED

FIGURE 6. Status LEDs

---



## Measured Amps

Including Amps sensors on the wires allows for a fast and efficient feed of information. The controller has separate built in sensor for measuring the battery amps and the motor amps. Both motor amps and battery amps are measured in real time.

## Electrical Specifications

### Absolute Maximum Values

The values in the table below should never be exceeded, Permanent damage to the controller may result.

TABLE 3.

Parameter	Measure point	Model	Min	Typical	Max	Units
Battery Leads Voltage	Ground to VBat	RGDC1860			63	Volts
		RGDC1896			100	Volts
Reverse Voltage on Battery Leads	Ground to VBat	All	-1			Volts
Motor Leads Voltage	Ground to M+, M-	RGDC1860			63	Volts
		RGDC1896			100	Volts
Digital Output Voltage	Ground to Output pins	All			40	Volts
Power Control	Ground to PowerControl pin	All	-1		50	Volts
Analog and Digital Inputs Voltage	Ground to any signal pin on I/O connectors	All			25	Volts
RS232 pin Voltage	External voltage applied to Rx pins	All	-25		25	Volts
CAN pins Voltage	External voltage applied to CANH/CANL pins	All	-25		25	Volts
Temperature	Board	All	-40		85	°C
Humidity	Board	All			100 (3)	%
Note 1: Maximum regeneration voltage in normal operation. Never inject a DC voltage from a battery or other fixed source Note 2: No voltage must be applied on Tx pin Note 3: Non condensing						

### Power Stage Electrical Specifications (at 25oC ambient)

TABLE 4

Parameter	Measure point	Model	Min	Typical	Max	Units
Battery Leads Voltage	Ground to VBat	RGDC1860	10 (1)		63	Volts
		RGDC1896	40 (1)		100	Volts
Motor Leads Voltage	Ground to M+, M-	RGDC1860			63 (2)	Volts
		RGDC1896			100 (2)	Volts
Over Voltage protection range	Ground to VBat	RGDC1860		60	65 (2)	Volts
		RGDC1896		96	100 (2)	Volts
Under Voltage protection range	Ground to VBat	All	20	20 (4)		Volts
Idle Current Consumption	VBat or Pwr Ctrl wires	All		50 (5)	100	mA



TABLE 5

Parameter	Measure point	Model	Min	Typical	Max	Units
ON Resistance (Excluding wire resistance)	VBat to A/B/C , plus A/B/C to Ground	All		0.7		mOhm
Max Current for 30s	Motor current	RGDC1860			300	Amps
		RGDC1896			300	Amps
Continuous Max Current	Motor current	RGDC1860			300 (6)	Amps
		RGDC1896			200 (6)	Amps
Current Limit range	Motor current	RGDC1860	10	300 (7)	300	Amps
		RGDC1896	10	200 (7)	300	Amps
Motor Acceleration/Deceleration range	Motor current	All	100	500 (8)	65000	milliseconds

Note 1: Voltage may drop to 0 if backup supply is connected to Power Control pin. Negative voltage will cause a large surge current. Protection fuse needed if battery polarity inversion is possible

Note 2: Maximum regeneration voltage in normal operation. Never inject a DC voltage from a battery or other fixed source

Note 3: Minimum voltage must be present on VBat or Power Control wire

Note 4: Factory default value. Adjustable in 0.1V increments

Note 5: Current consumption is lower when higher voltage is applied to the controller's VBat or PwrCtrl wires

Note 6: Estimate. Limited by heatsink temperature. Current may be higher with better cooling

Note 7: Factory default value. Adjustable in 0.1A increments

Note 8: Factory default value. Time in ms for power to go from 0 to 100%

## Command, I/O and Sensor Signals Specifications

TABLE 6.

Parameter	Measure point	Min	Typical	Max	Units
5V Out Voltage	Ground to 5V pin	4.8	5.1	5.2	Volts
5V Output Current	Output to ground			100	mA
Digital Output Voltage	Ground to Output pins			40	Volts
Digital Output Current	Output pins, sink current			1	Amps
Digital Input 0 Level	Ground to Input pins	-1		1	Volts
Digital Input 1 Level	Ground to Input pins	3		25	Volts
Analog Input Range	Ground to Input pins	0		5.1	Volts
Analog Input Precision	Ground to Input pins		0.5		%
Pulse durations	Pulse inputs	20000		10	us
Pulse repeat rate	Pulse inputs	50		250	Hz
Pulse Capture Resolution	Pulse inputs		1		us
Frequency Capture	Pulse inputs	100		1000	Hz
Encoder count	Internal	-2.147		2.147	10 <sup>9</sup> Counts
Encoder frequency	Encoder input pins			1M	Counts/s

## Operating and Timing Specifications

TABLE 7.

Parameter	Measure Point	Min	Typical	Max	Units
Command Latency	Command to output change	0	1	2	ms
PWM Frequency	Motor outputs	10	16	20	kHz
Closed Loop update rate	Internal		1000		Hz
Serial baud rate	Rx & Tx pins		115200 (1)		Bits/s
Serial Watchdog timeout	Rx pin	1 (2)		65000	ms

Note 1: 115200, 8-bit, no parity, 1 stop bit, no flow control  
 Note 2: May be disabled with value 0

## Scripting

TABLE 8.

Parameter	Measure Point	Min	Typical	Max	Units
Scripting Flash Memory	Internal		32000	32768	Bytes
Max Basic Language programs	Internal		4000	5000	Lines
Integer Variables	Internal		4096		Words (1)
Boolean Variables	Internal		8192		Symbols
Execution Speed	Internal	50000	100000		Lines/s

Note 1: 32-bit words

## Thermal Specifications

TABLE 9.

Parameter	Measure Point	Min	Typical	Max	Units
Board Temperature	PCB	-40		85 (1)	°C
Thermal Protection range	PCB	70		80 (2)	°C
Thermal resistance	Power MOSFETs to heats sink			2	°C/W

Note 1: Thermal protection will protect the controller power  
 Note 2: Max allowed power out starts lowering at minimum of range, down to 0 at max of range

## Mechanical Specifications

TABLE 10.

Parameter	Measure Point	Min	Typical	Max	Units
Weight	Unit		2940 (6.48)		g (lbs)
Power Terminals	Connection		M6 (1)		Thread

Note 1: Use M6 x 12mm long screws with washer between screw head and cable.

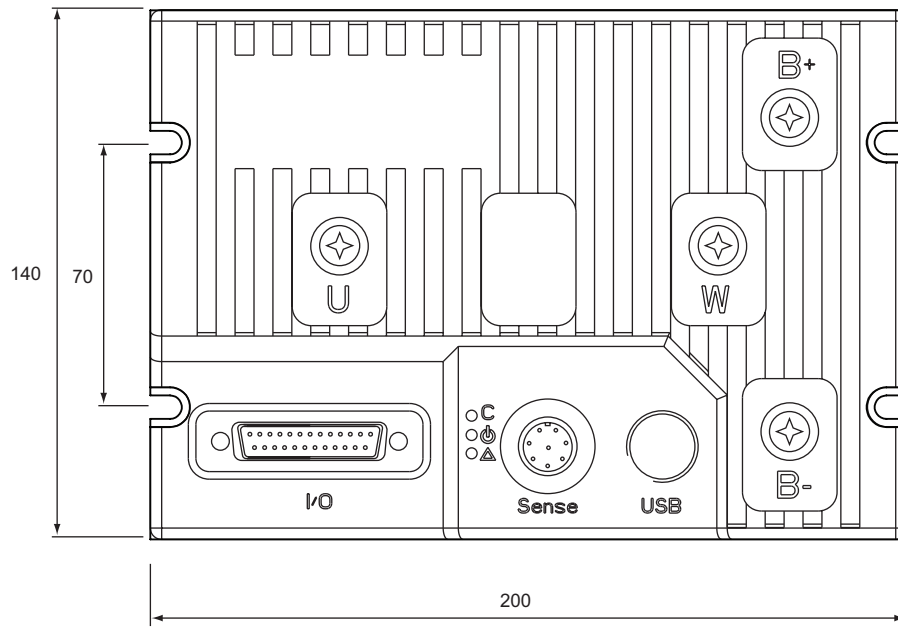

FIGURE 10. RGDC18xx Top View and Dimensions

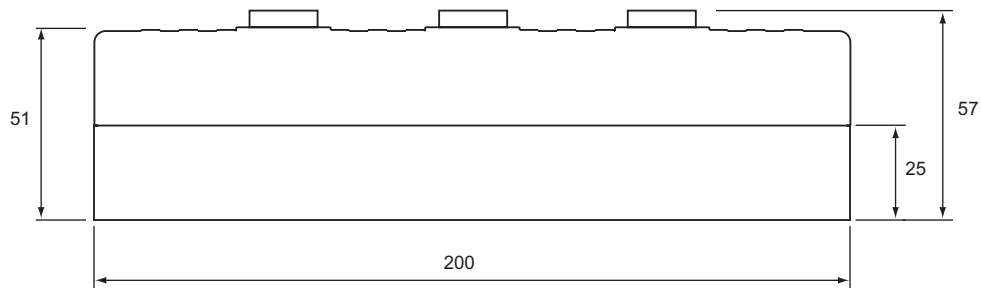

FIGURE 11. RGL18xx Side View and Dimensions