

① Board dimensions (top view)  
Scale 3:1

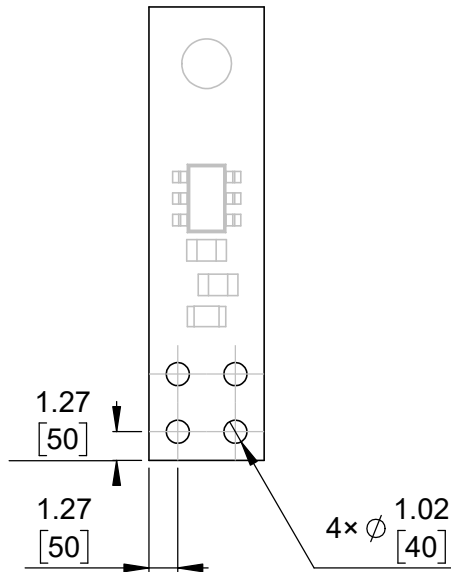

② Connector callouts (bottom view)  
Scale 3:1



③ Isometric view  
Scale 3:1

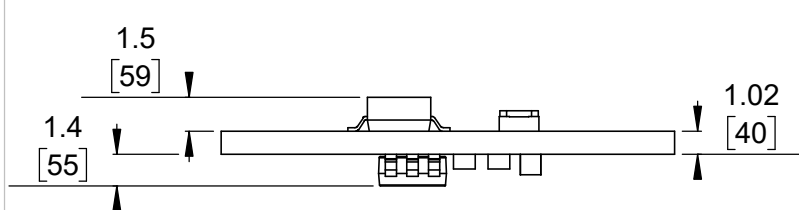

④ Profile  
Scale 3:1

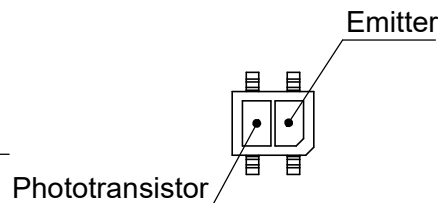

⑤ QTR sensor  
Scale 3:1



⑥ Actual size  
Scale 1:1

1. Intended for #2 and M2 screws.
2. Grid lines indicate 2.54 mm [100 mil] spacing.
3. To get the specified scale, select 100% in print settings.
4. Drill location tolerance:  $\pm 0.1$  [ $\pm 5$ ].
5. Board edge tolerance:  $\pm 0.3$  [ $\pm 10$ ].

<https://www.pololu.com/category/123>

Name: QTR-HD-01x Reflectance Sensor		Item number: 4101, 4201
Drawing date: 14 September 2018	Dev code: irs21a	 <b>Pololu</b> Robotics & Electronics © 2018 Pololu Corporation
Units: mm [mil]	Material: mixed	

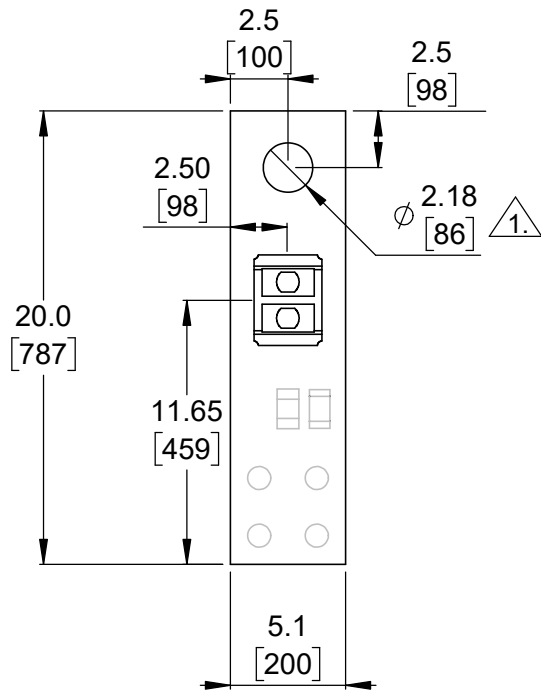

① Board dimensions (top view)  
Scale 3:1

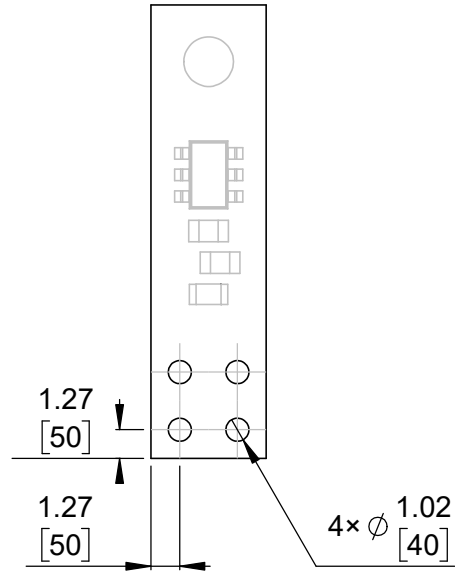

② Connector callouts (bottom view)  
Scale 3:1



③ Isometric view  
Scale 3:1

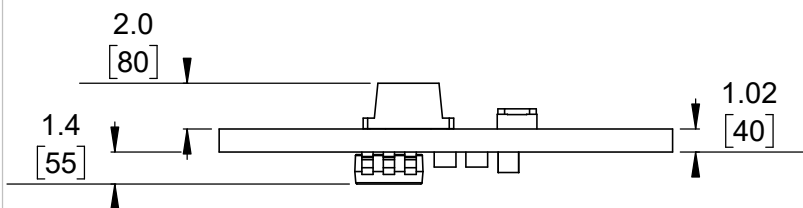

④ Profile  
Scale 3:1

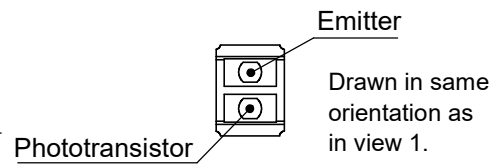

⑤ QTRX/QTRXL sensor  
Scale 3:1

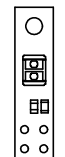

⑥ Actual size  
Scale 1:1

- 1. Intended for #2 and M2 screws.
- 2. Grid lines indicate 2.54 mm [100 mil] spacing.
- 3. To get the specified scale, select 100% in print settings.
- 4. Drill location tolerance:  $\pm 0.1$  [ $\pm 5$ ].
- 5. Board edge tolerance:  $\pm 0.3$  [ $\pm 10$ ].

<a href="https://www.pololu.com/category/123">https://www.pololu.com/category/123</a>	
Name: QTRX/QTRXL-HD-01x Reflectance Sensor	Item number: 4301, 4401, 4501, 4601
Drawing date: 14 September 2018	Dev code: irs21j
Units: mm [mil]	Material: mixed
 © 2018 Pololu Corporation	

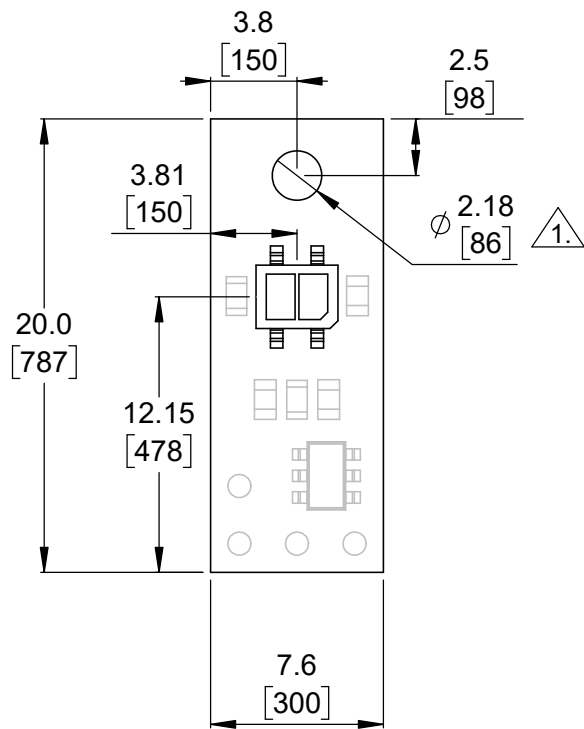

① Board dimensions (top view)  
Scale 3:1

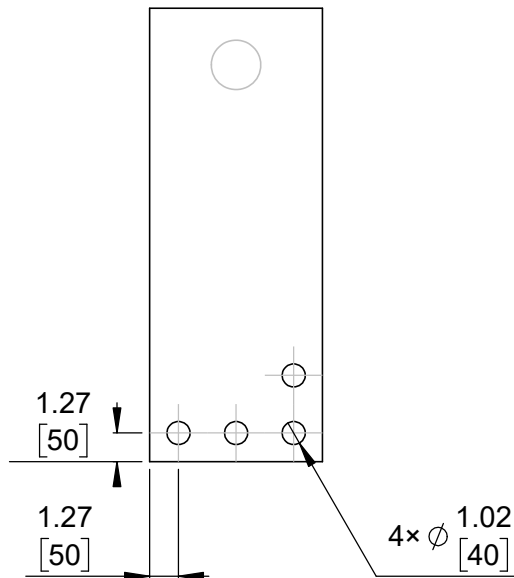

② Connector callouts (bottom view)  
Scale 3:1

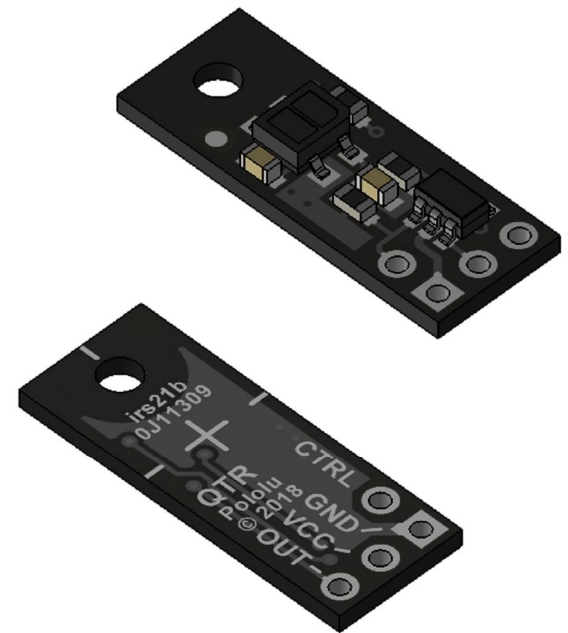

③ Isometric view  
Scale 3:1

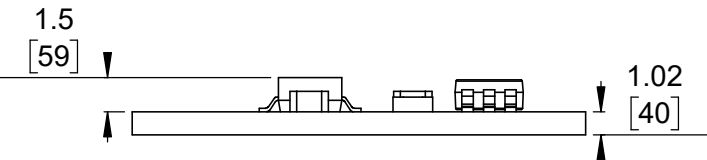

④ Profile  
Scale 3:1

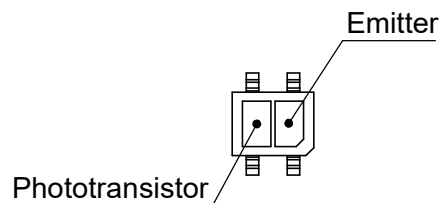

⑤ QTR sensor  
Scale 3:1

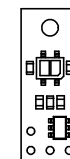

⑥ Actual size  
Scale 1:1

- ①. Intended for #2 and M2 screws.
- ②. Grid lines indicate 2.54 mm [100 mil] spacing.
- ③. To get the specified scale, select 100% in print settings.
- ④. Drill location tolerance:  $\pm 0.1$  [ $\pm 5$ ].
- ⑤. Board edge tolerance:  $\pm 0.3$  [ $\pm 10$ ].

<https://www.pololu.com/category/123>

Name: QTR-MD-01x Reflectance Sensor		Item number: 4141, 4241	
Drawing date: 14 September 2018	Dev code: irs21b	 <b>Pololu</b> Robotics & Electronics © 2018 Pololu Corporation	
Units: mm [mil]	Material: mixed		

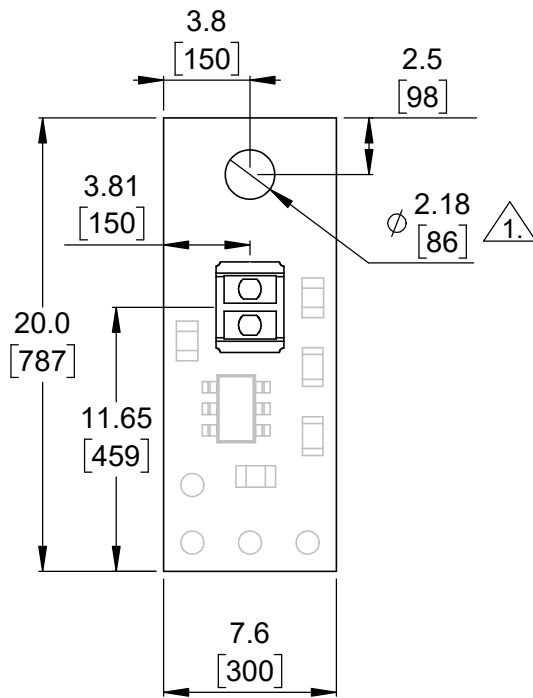

① Board dimensions (top view)  
Scale 3:1

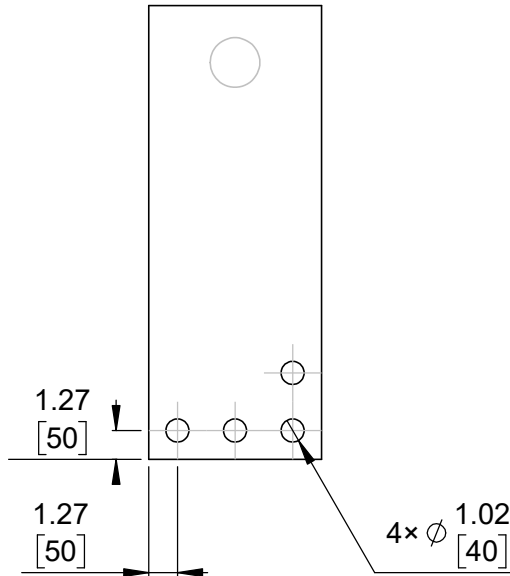

② Connector callouts (bottom view)  
Scale 3:1

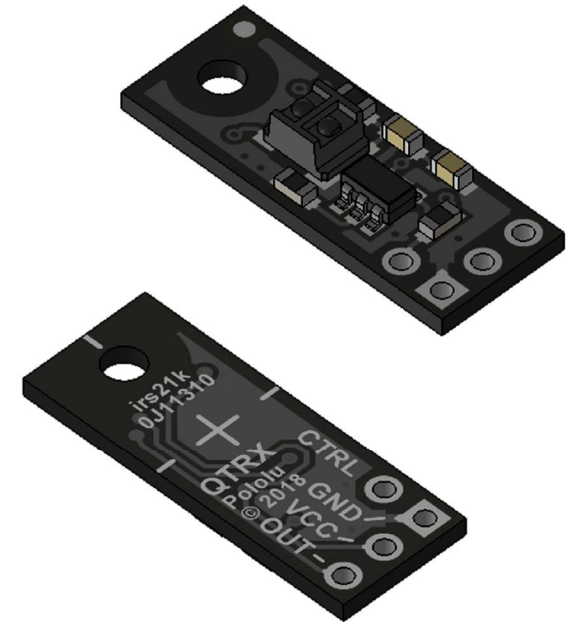

③ Isometric view  
Scale 3:1

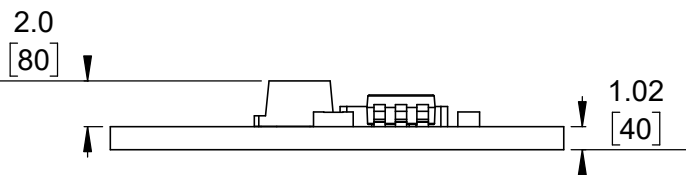

④ Profile  
Scale 3:1

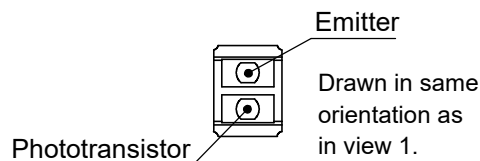

⑤ QTRX/QTRXL sensor  
Scale 3:1

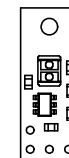

⑥ Actual size  
Scale 1:1

- 1. Intended for #2 and M2 screws.
- 2. Grid lines indicate 2.54 mm [100 mil] spacing.
- 3. To get the specified scale, select 100% in print settings.
- 4. Drill location tolerance:  $\pm 0.1$  [ $\pm 5$ ].
- 5. Board edge tolerance:  $\pm 0.3$  [ $\pm 10$ ].

<https://www.pololu.com/category/123>

Name: QTRX/QTRXL-MD-01x Reflectance Sensor		Item number: 4341, 4441, 4541, 4641
Drawing date: 14 September 2018	Dev code: irs21k	 © 2018 Pololu Corporation
Units: mm [mil]	Material: mixed	

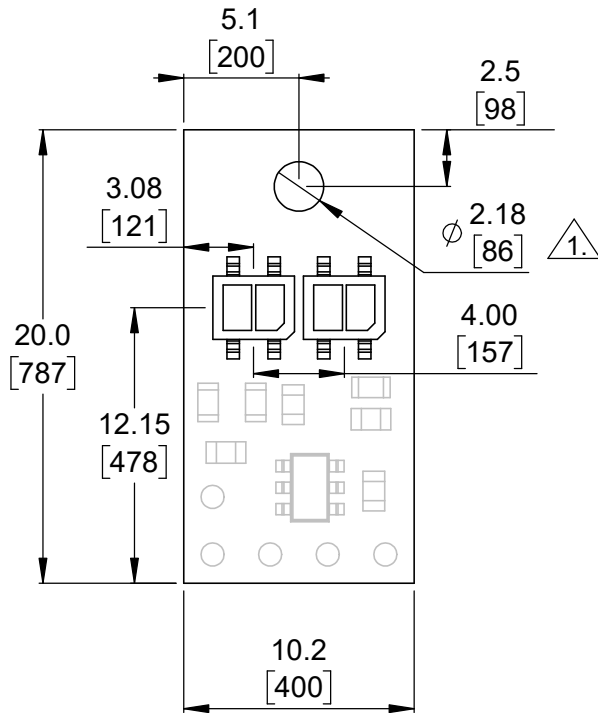

① Board dimensions (top view)  
Scale 3:1

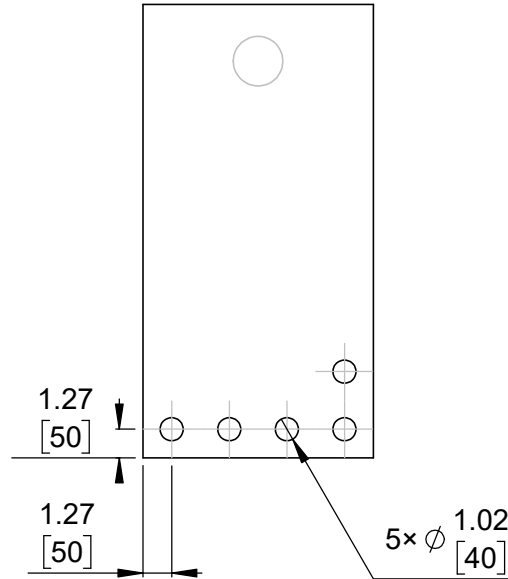

② Connector callouts (bottom view)  
Scale 3:1

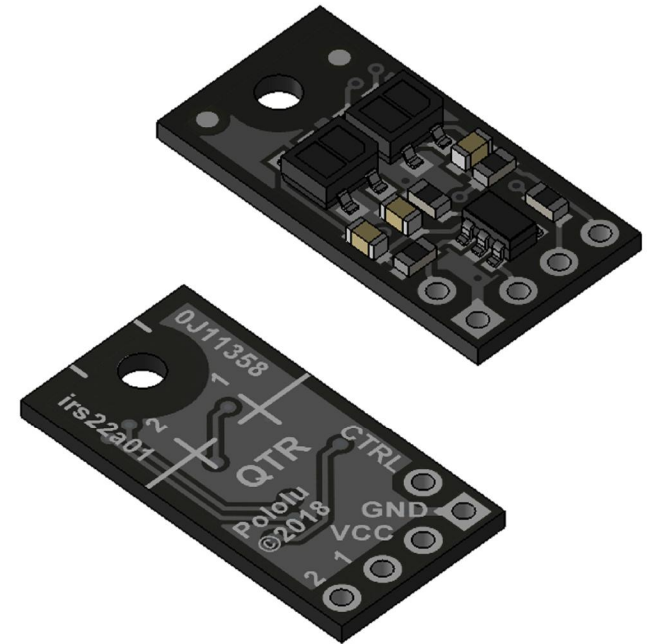

③ Isometric view  
Scale 3:1

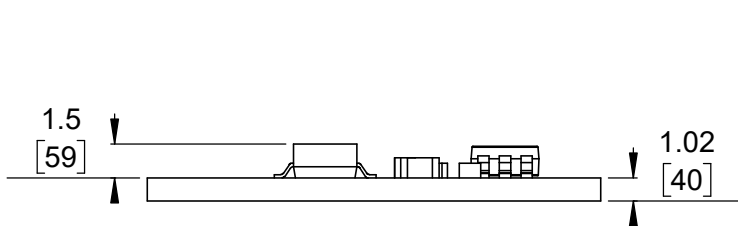

④ Profile  
Scale 3:1

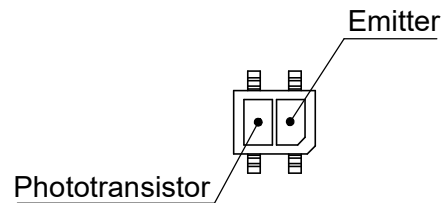

⑤ QTR sensor  
Scale 3:1

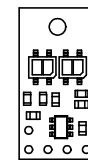

⑥ Actual size  
Scale 1:1

- 1. Intended for #2 and M2 screws.
- 2. Grid lines indicate 2.54 mm [100 mil] spacing.
- 3. To get the specified scale, select 100% in print settings.
- 4. Drill location tolerance:  $\pm 0.1$  [ $\pm 5$ ].
- 5. Board edge tolerance:  $\pm 0.3$  [ $\pm 10$ ].

<https://www.pololu.com/category/123>

Name: QTR-HD-02x Reflectance Sensor Array		Item number: 4102, 4202	
Drawing date: 14 September 2018		Dev code: irs22a	
Units: mm [mil]	Material: mixed		



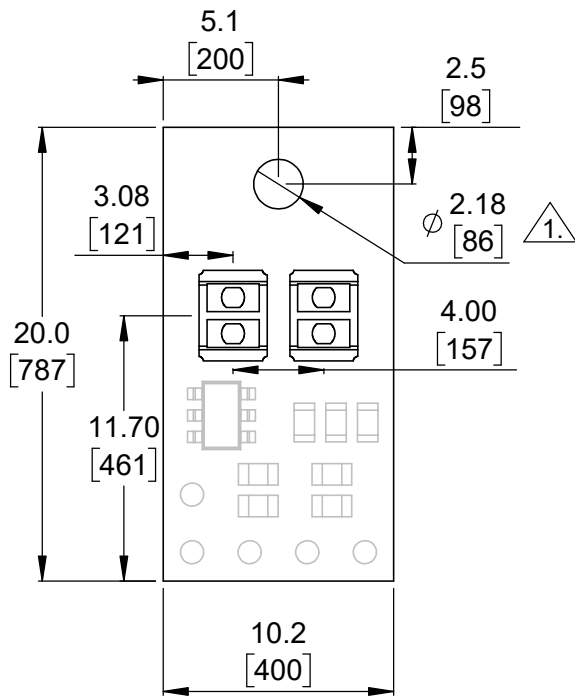

1 Board dimensions (top view)  
Scale 3:1

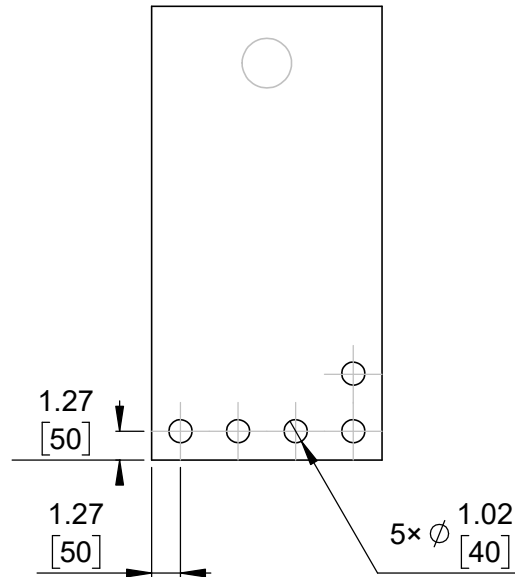

2 Connector callouts (bottom view)  
Scale 3:1

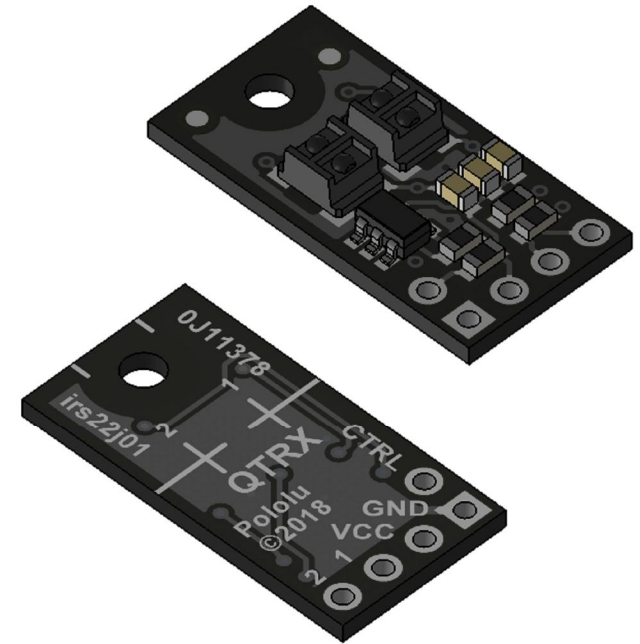

3 Isometric view  
Scale 3:1

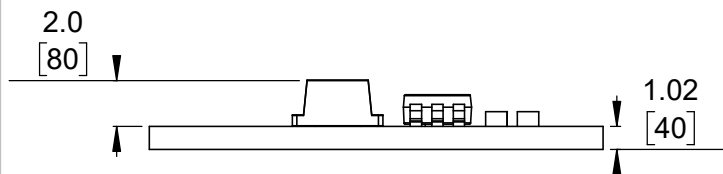

4 Profile  
Scale 3:1

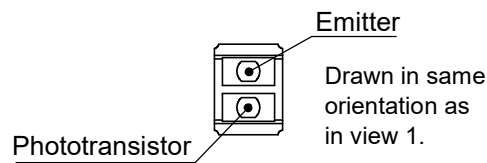

5 QTRX/QTRXL sensor  
Scale 3:1

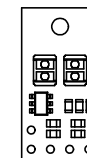

6 Actual size  
Scale 1:1

- 1. Intended for #2 and M2 screws.
- 2. Grid lines indicate 2.54 mm [100 mil] spacing.
- 3. To get the specified scale, select 100% in print settings.
- 4. Drill location tolerance:  $\pm 0.1$  [ $\pm 5$ ].
- 5. Board edge tolerance:  $\pm 0.3$  [ $\pm 10$ ].

<https://www.pololu.com/category/123>

Name: QTRX/QTRXL-HD-02x Reflectance Sensor Array		Item number: 4302, 4402, 4502, 4602
Drawing date: 14 September 2018	Dev code: irs22j	 © 2018 Pololu Corporation
Units: mm [mil]	Material: mixed	

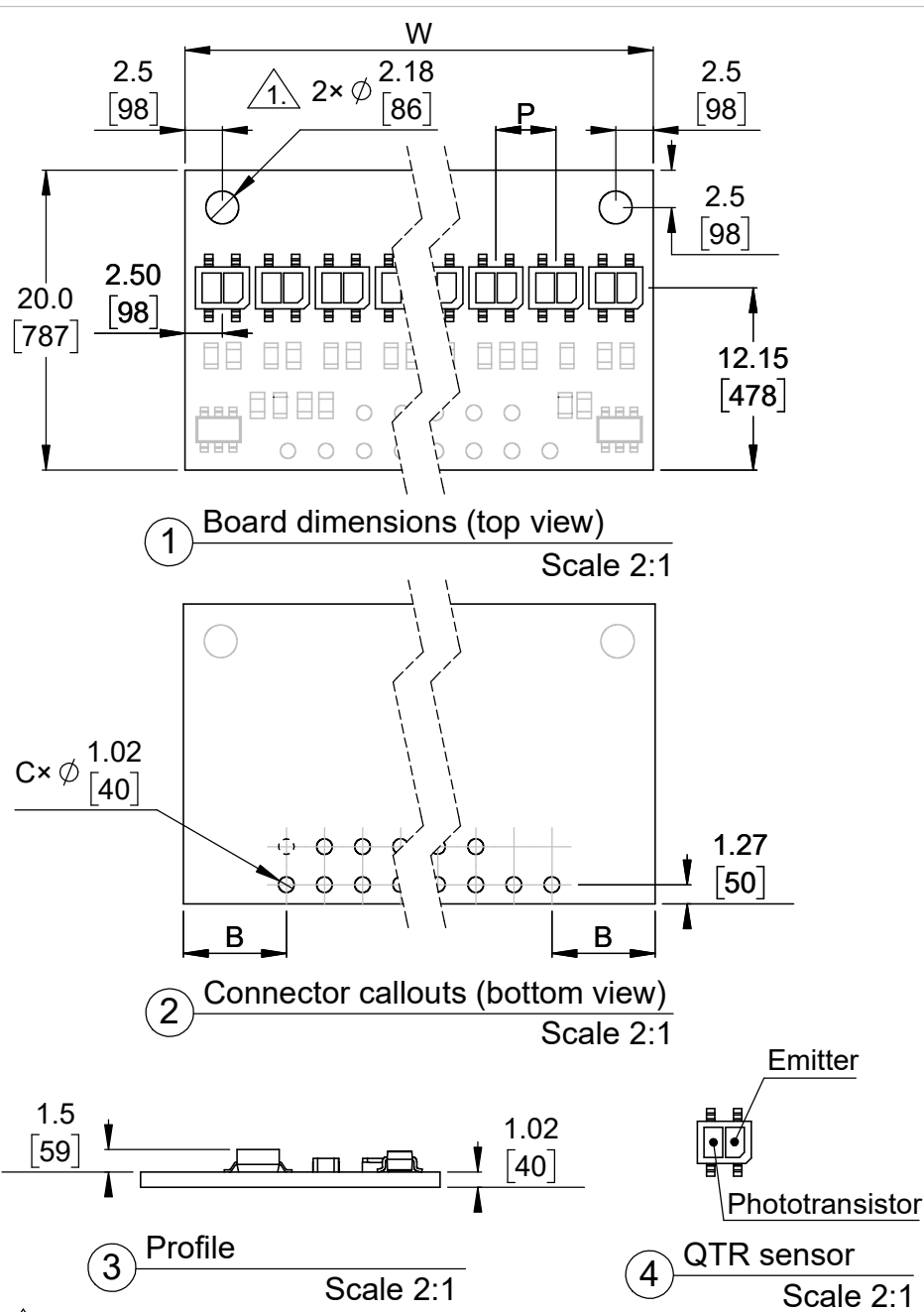

1. Intended for #2 and M2 screws.
2. Grid lines indicate 2.54 mm [100 mil] spacing.
3. To get the specified scale, select 100% in print settings.
4. Drill location tolerance:  $\pm 0.1$  [ $\pm 5$ ].
5. Board edge tolerance:  $\pm 0.3$  [ $\pm 10$ ].

Item numbers*	W (width)	P (pitch)	N (number of sensors)	B	C (hole count)
4103, 4203	13.0 [512]	4.00 [157]	3	1.42 [56]	7
4142, 4242		8.00 [315]	2		
4104, 4204	17.0 [669]	4.00 [157]	4	3.42 [135]	8
4105, 4205	21.0 [827]	4.00 [157]	5	4.15 [163]	9
4143, 4243		8.00 [315]	3		
4106, 4206	25.0 [984]	4.00 [157]	6	6.15 [242]	10
4107, 4207	29.0 [1142]	4.00 [157]	7	6.88 [271]	11
4144, 4244		8.00 [315]	4		
4108, 4208	33.0 [1299]	4.00 [157]	8	8.88 [350]	12
4109, 4209	37.0 [1457]	4.00 [157]	9	9.61 [378]	13
4145, 4245		8.00 [315]	5		
4111, 4211	45.0 [1772]	4.00 [157]	11	12.34 [486]	15
4146, 4246		8.00 [315]	6		
4113, 4213	53.0 [2087]	4.00 [157]	13	15.07 [593]	17
4147, 4247		8.00 [315]	7		
4115, 4215	61.0 [2402]	4.00 [157]	15	17.80 [701]	19
4108, 4208		8.00 [315]	8		
4117, 4217	69.0 [2717]	4.00 [157]	17	20.53 [808]	21
4109, 4209		8.00 [315]	9		
4119, 4219	77.0 [3031]	4.00 [157]	19	23.26 [916]	23
4110, 4210		8.00 [315]	10		

\*Some items available by special order only.

<https://www.pololu.com/category/123>

Name: QTR Reflectance Sensor Array		Item number: see table
Drawing date: 14 September 2018	Dev code: irs23a-irs39a	 © 2018 Pololu Corporation
Units: mm [mil]	Material: mixed	

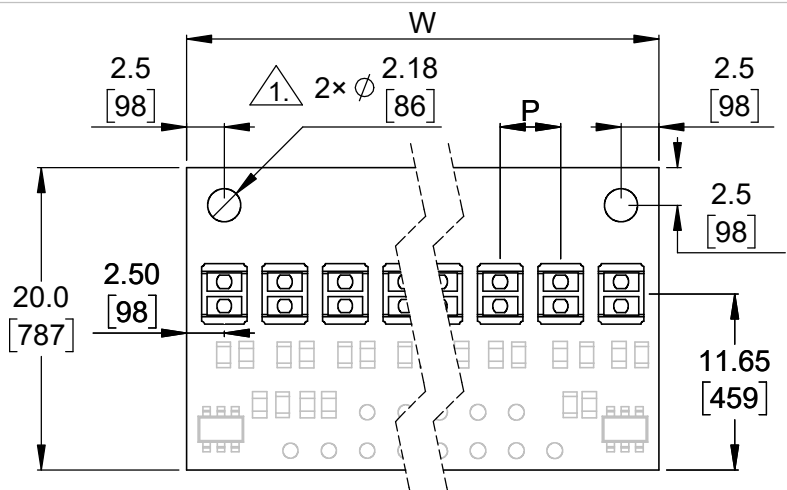

1 Board dimensions (top view)  
Scale 2:1

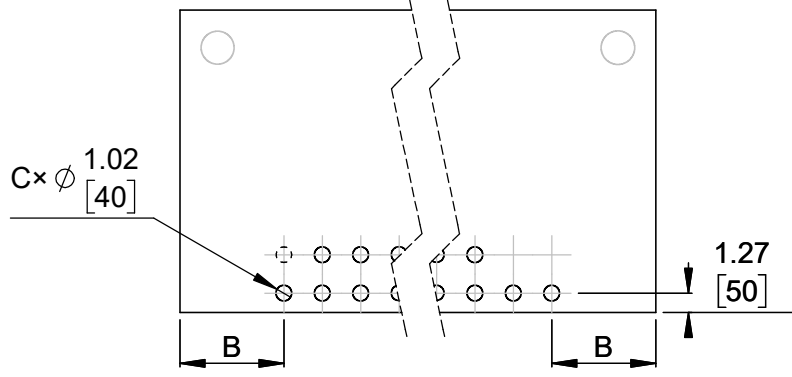

2 Connector callouts (bottom view)  
Scale 2:1

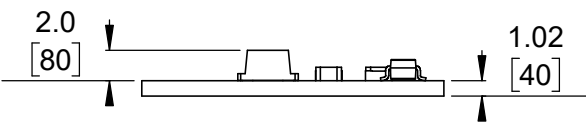

3 Profile  
Scale 2:1

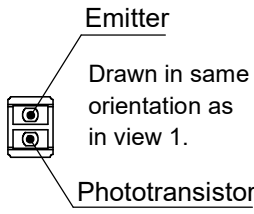

4 QTRX/QTRXL sensor  
Scale 2:1

1. Intended for #2 and M2 screws.
2. Grid lines indicate 2.54 mm [100 mil] spacing.
3. To get the specified scale, select 100% in print settings.
4. Drill location tolerance:  $\pm 0.1$  [ $\pm 5$ ].
5. Board edge tolerance:  $\pm 0.3$  [ $\pm 10$ ].

Item numbers*	W (width)	P (pitch)	N (number of sensors)	B	C (hole count)
4303, 4403, 4503, 4603	13.0	4.00	3	1.42	7
4342, 4442, 4542, 4642	[512]	8.00	2	[56]	
4304, 4404, 4504, 4604	17.0	4.00	4	3.42	8
4305, 4405, 4505, 4605	21.0	4.00	5	4.15	9
4343, 4443, 4543, 4643	[827]	8.00	3	[163]	
4306, 4406, 4506, 4606	25.0	4.00	6	6.15	10
4307, 4407, 4507, 4607	29.0	4.00	7	6.88	11
4344, 4444, 4544, 4644	[1142]	8.00	4	[315]	
4308, 4408, 4508, 4608	33.0	4.00	8	8.88	12
4309, 4409, 4509, 4609	37.0	4.00	9	9.61	13
4345, 4445, 4545, 4645	[1457]	8.00	5	[315]	
4311, 4411, 4511, 4611	45.0	4.00	11	12.34	15
4346, 4446, 4546, 4646	[1772]	8.00	6	[486]	
4313, 4413, 4513, 4613	53.0	4.00	13	15.07	17
4347, 4447, 4547, 4647	[2087]	8.00	7	[315]	
4315, 4415, 4515, 4615	61.0	4.00	15	17.80	19
4348, 4448, 4548, 4648	[2402]	8.00	8	[701]	
4317, 4417, 4517, 4617	69.0	4.00	17	20.53	21
4349, 4449, 4549, 4649	[2717]	8.00	9	[315]	
4319, 4419, 4519, 4619	77.0	4.00	19	23.26	23
4350, 4450, 4550, 4650	[3031]	8.00	10	[315]	

\*Some items available by special order only.

<https://www.pololu.com/category/123>

Name: QTRX/QTRXL Reflectance Sensor Array		Item number: see table
Drawing date: 14 September 2018	Dev code: irs23j-irs39j	 © 2018 Pololu Corporation
Units: mm [mil]	Material: mixed	



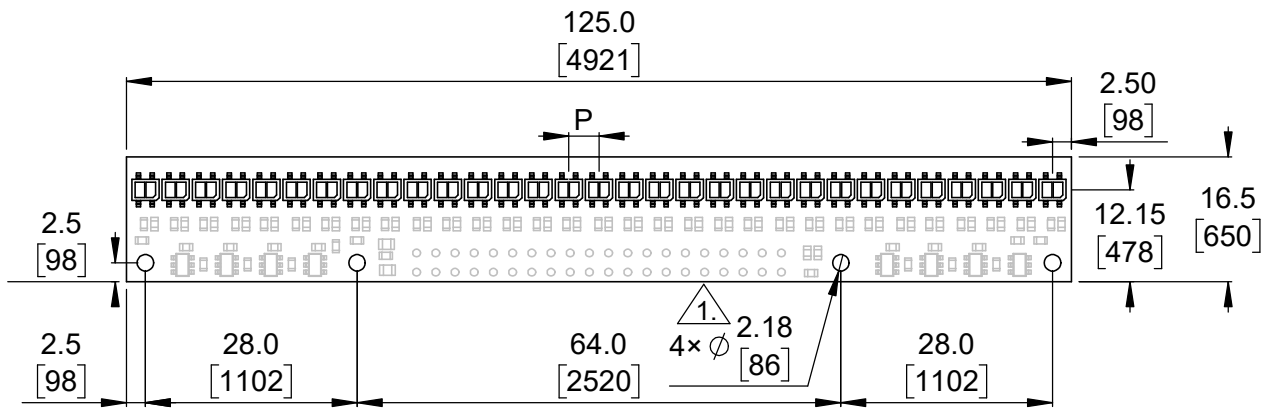

1 Board dimensions (top view)  
 Scale 1:1

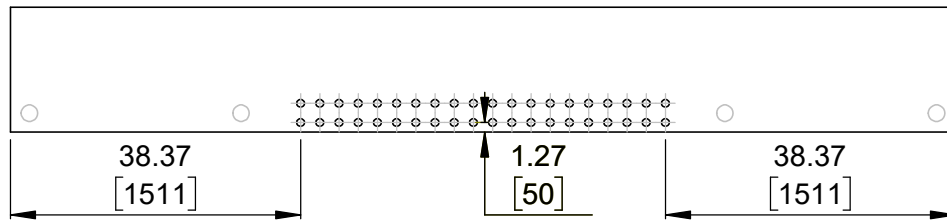

2 Connector callouts (bottom view)  
 Scale 1:1

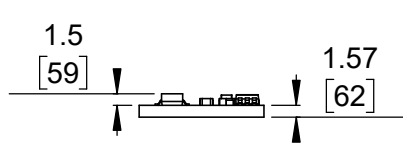

3 Profile  
 Scale 1:1

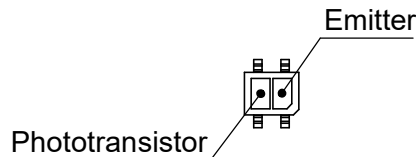

4 QTR sensor  
 Scale 2:1

Item numbers*	P (pitch)	N (number of sensors)
4131, 4231	4.00 [157]	31
4156, 4256	8.00 [315]	16

\*Some items available by special order only.



5 Isometric view  
 Scale 1:1

- 1. Intended for #2 and M2 screws.
- 2. Grid lines indicate 2.54 mm [100 mil] spacing.
- 3. To get the specified scale, select 100% in print settings.
- 4. Drill location tolerance: ±0.1 [±5].
- 5. Board edge tolerance: ±0.3 [±10].

<https://www.pololu.com/category/123>

Name: QTR Reflectance Sensor Array		Item number: see table
Drawing date: 14 September 2018	Dev code: irs51a	 © 2018 Pololu Corporation
Units: mm [mil]	Material: mixed	

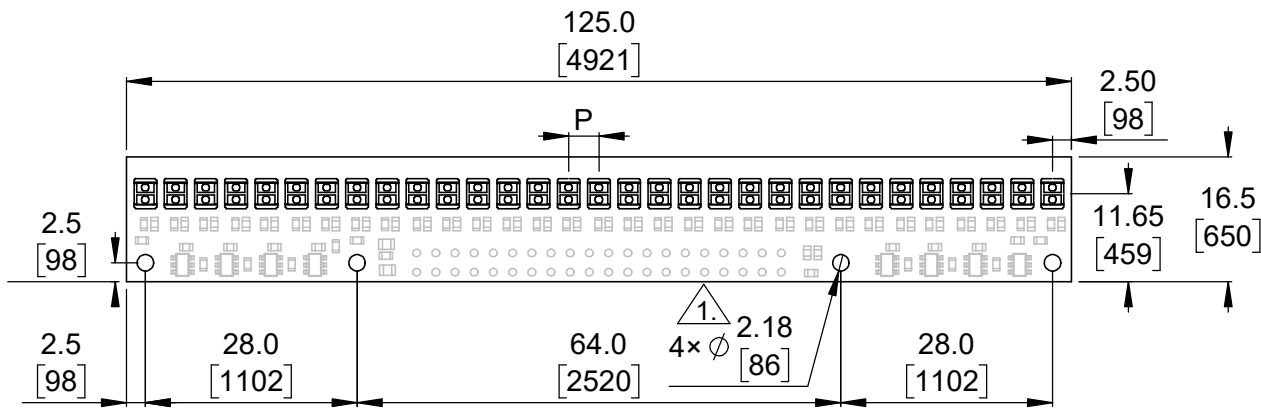

① Board dimensions (top view)  
Scale 1:1

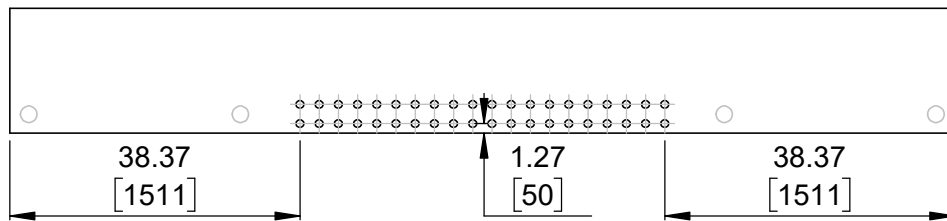

② Connector callouts (bottom view)  
Scale 1:1

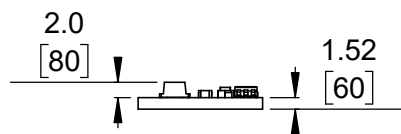

③ Profile  
Scale 1:1

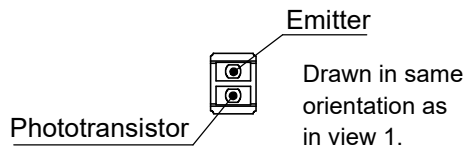

④ QTRX/QTRXL sensor  
Scale 2:1

Item numbers*	P (pitch)	N (number of sensors)
4331, 4431, 4531, 4631	4.00 [157]	31
4356, 4456, 4556, 4656	8.00 [315]	16

\*Some items available by special order only.



⑤ Isometric view  
Scale 1:1

- 1. Intended for #2 and M2 screws.
- 2. Grid lines indicate 2.54 mm [100 mil] spacing.
- 3. To get the specified scale, select 100% in print settings.
- 4. Drill location tolerance:  $\pm 0.1$  [ $\pm 5$ ].
- 5. Board edge tolerance:  $\pm 0.3$  [ $\pm 10$ ].

<https://www.pololu.com/category/123>

Name: QTRX/QTRXL Reflectance Sensor Array		Item number: see table
Drawing date: 14 September 2018	Dev code: irs51j	 © 2018 Pololu Corporation
Units: mm [mil]	Material: mixed	