

XBee Adapter Board (#32403)

This low cost XBee Adapter Board comes in a kit form and provides a cost-effective solution to interfacing to any XBee or XBee Pro module. By using this adapter board you can provide an easy interface to the XBee or XBee Pro modules by converting the 2mm pin spacing to breadboard friendly 0.100" spacing. The adapter boards also provide a means to connect pluggable wires or solder connections and also provide mounting holes.

Features

- Converts XBee 2mm pin spacing to 0.100" pin spacing
- Provides easy pluggable wire or solder connections
- Includes mounting holes
- Pin-out compatible with our other XBee Adapter boards
- Kit form for flexible configuration

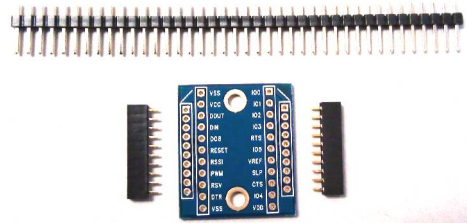

Key Specifications

- Power requirements: 3.3V pass-through to XBee module
- Communication: Serial pass-through to XBee module
- Operating temperature: -40 to +185°F (-40 to +85°C)
- Dimensions: 1.16" L x 1.00" W x 0.58" H* (29.4 mm x 25.6 mm x 14.8 mm*)
* when headers are attached

Application Ideas

- Easy connection of XBee modules to breadboard or proto board
- Convenient way to mount the XBee module away from the microcontroller

Packing List

- (1) XBee Adapter Board PCB
- (2) 10-pin 2mm sockets
- (1) 40-pin SIP header

Tools Required

- Soldering Iron (always wear safety glasses when soldering)
- Solder (some soldering experience required)
- Flux (if not using rosin/flux-core solder)
- Diagonal cutters or Exacto knife (optional)

Assembly Instructions

Step 1:

Check to ensure your kit contains the following parts as shown in the photo.

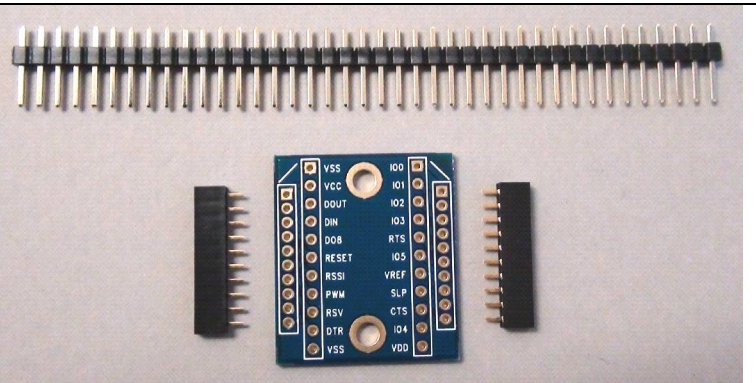

Step 2:

Install the 2mm sockets on top of the PCB as shown and solder them in place from the bottom side of the board.

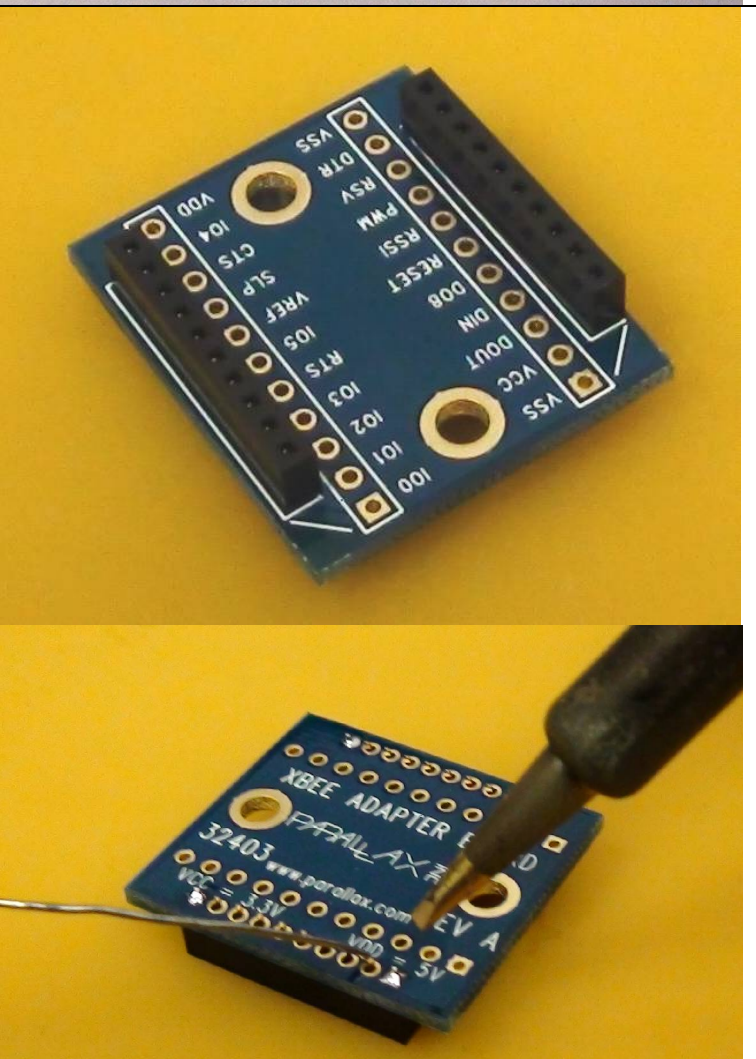

Step 3:

Using an Exacto knife, hobby knife or a pair of diagonal cutters, cut two 11-pin headers from the 40-pin header. Extra header material was included in case of a mistake or damaged header.

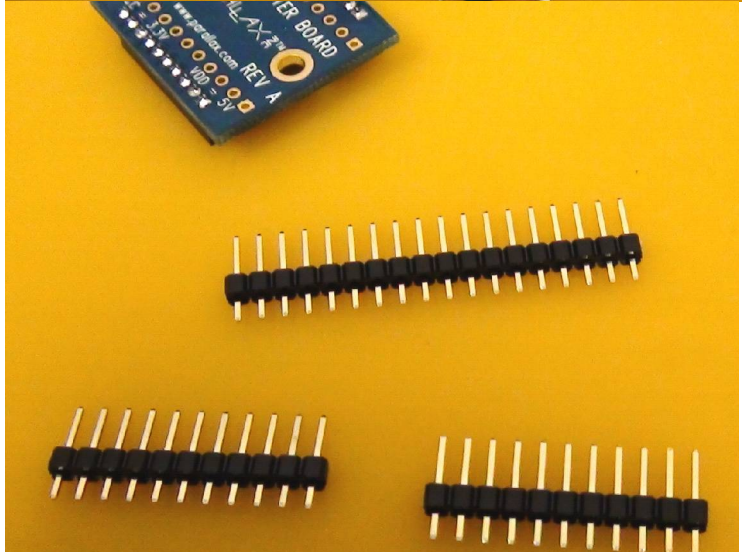
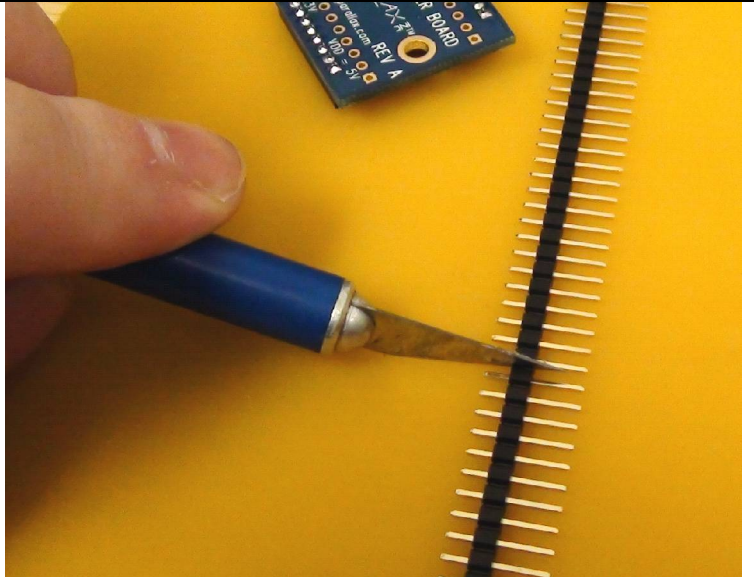
**Step 4 (optional):**

Insert the two 11-pin SIP headers into the bottom of the adapter board as shown and solder them in place from the top.

This step is optional in that you could leave the headers out and solder wires into the pads instead if you wish.

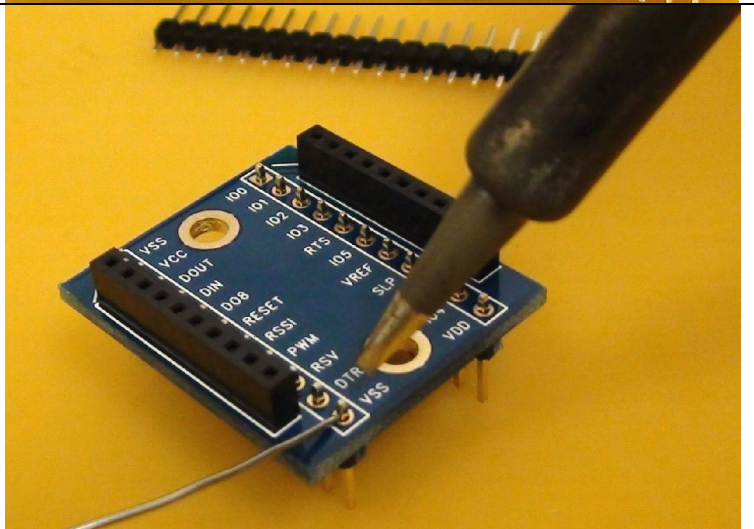

Adapter Board Dimensions

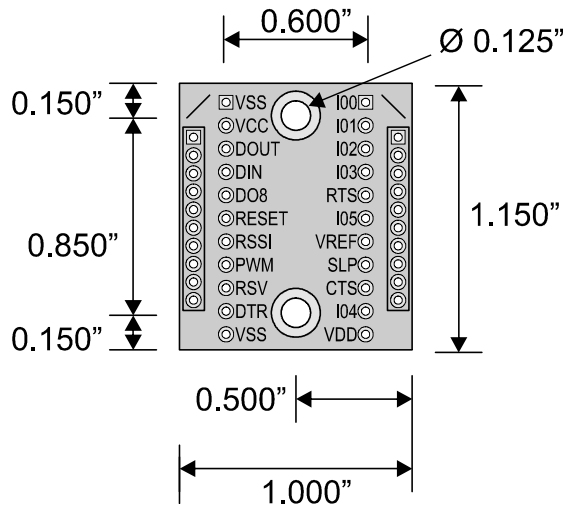

Adapter Board Schematic

The schematic below shows the relationship between the connections on the XBee module (outer sockets) and the headers from the Adapter Board. **Please note that the lower-right pin (labeled VDD) is not used on this adapter but is shown for compatibility with our other XBee Adapter boards.**

