

18 PIN PROJECT BOARD WITH OUTPUT DRIVERS

- CHI-030 Standard 18-pin Project Board
- CHI-035 High Power 18-pin Project Board
- Also available*
- CHI-040 8 pin Project Board
- AXE-020 28 pin Project Board

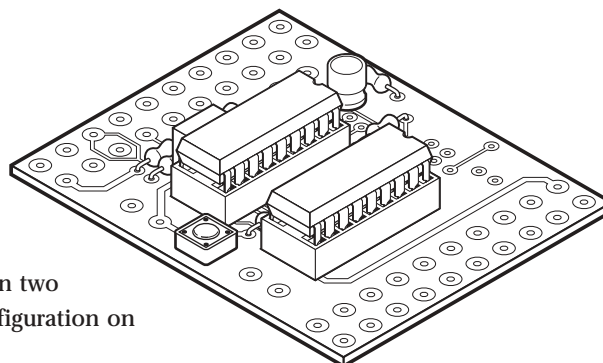

Introduction

The 18 pin microcontroller project boards are available in two configurations, standard and high-power. The input configuration on both boards is identical, providing up to 5 inputs.

The standard board uses a darlington driver IC to provide 8 digital (on/off) outputs. Each output is rated at 800mA.

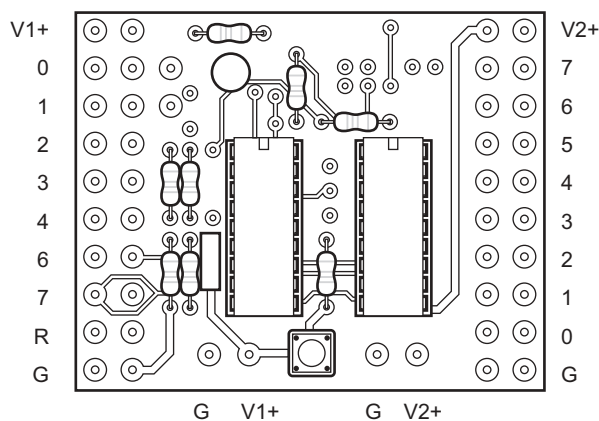

The high power board uses 4 FETs to provide 4 high power digital outputs (rated at 1.5A each), and the option of a L293D motor driver IC to provide 2 reversible motor outputs, rated at 1A each. Please note that the L293D chip must be purchased separately.

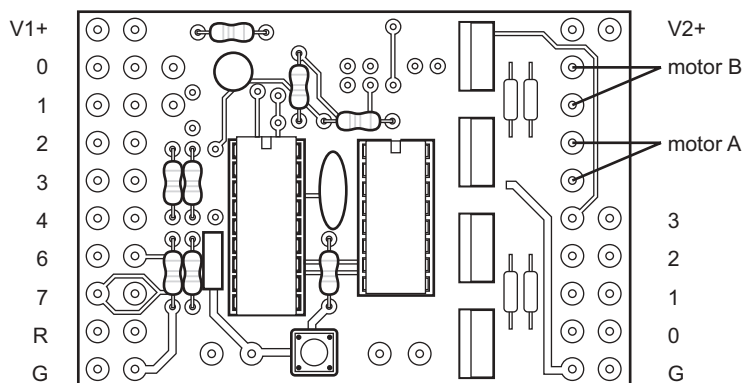

Both boards are supplied ready for use with a PICAXE-18 or PIC16F627 microcontroller. However the boards may be modified as described in Appendix A for use with the older style PIC16F84A (or any other 18 pin microcontroller).

Project Boards Power Supply

The projects board require a single 3-5V power supply to operate. We recommend this is supplied via AA cell battery packs, connected to the V2+ terminal connections beside the reset switch. This pack will then power the microcontroller and the output devices.

The black wire is connected to the G (ground) connection and the red wire to the V2+ connection.

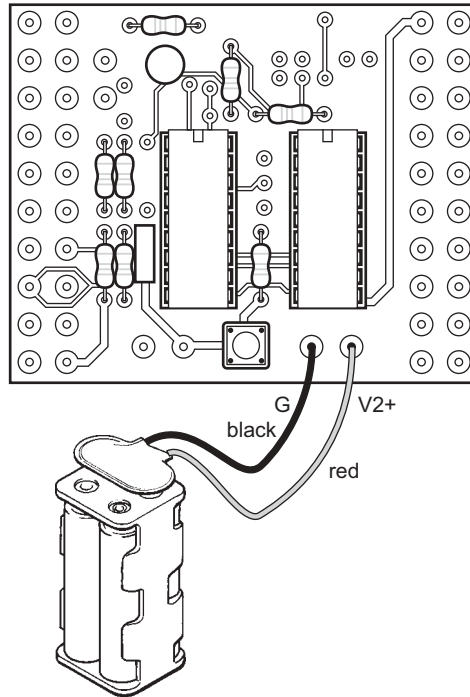

If a higher voltage (e.g. 12V) is required to drive the FET or darlington outputs, two separate power supplies may be used. In this case the second power supply only powers the output devices. The 3-5V power supply is connected to V1+ and the second 12V power supply is connected to V2+. When using two power supplies the resistor shown must be cut off the board to separate the supplies.

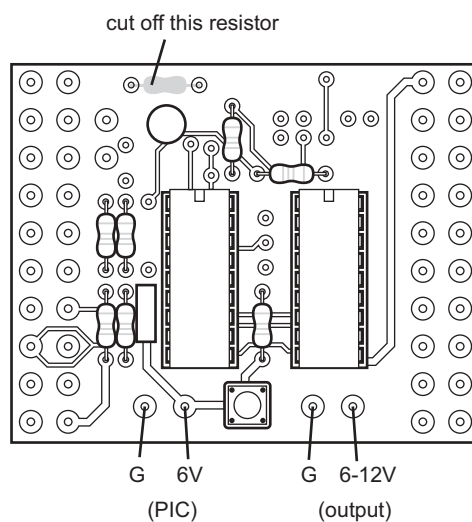

Output Devices

Output devices are connected between the pairs of holes on the pcb (pin and V2+) as shown below.

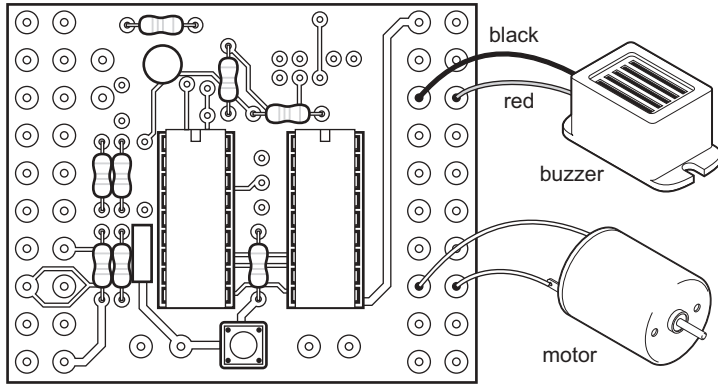

Note that motors should be suppressed by soldering a 220nF polyester capacitor across the motor terminals to prevent electrical noise affecting the circuit.

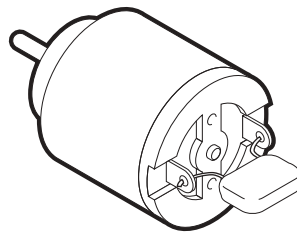

Controlling Motors on the High Power Board

To control motors an L293D motor driver IC must be fitted to the board as shown below. Only a single 4.5-6V supply should be used with motor outputs.

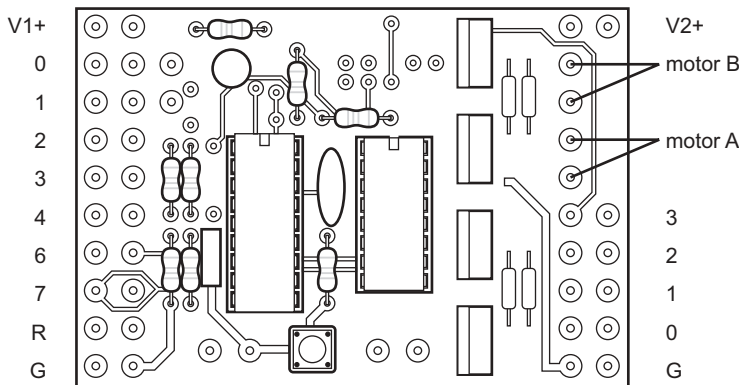

Note that there is a 1.5V voltage drop within the chip and so, for instance, if a 6V supply is used the motor voltage will be 4.5V.

The chip is designed to run warm in use. This is normal.
The direction of rotation of the motors is defined as follows:

Pin 4	Pin 5	Motor A
off	off	off
on	off	forward
off	on	reverse
on	on	off

Pin 6	Pin 7	Motor B
off	off	off
on	off	forward
off	on	reverse
on	on	off

Input Devices

Analogue inputs are connected to input 0 (A) and input 1 (B) as shown.

Digital inputs are connected between V1+ and the pin as shown below.

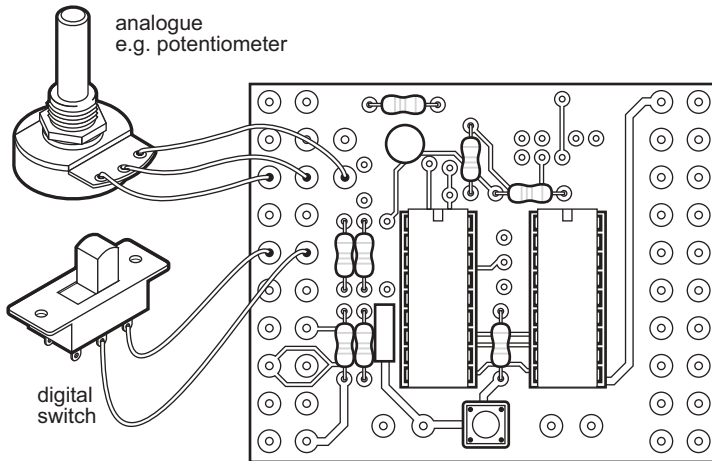

Note that input 5 does not exist. This is a characteristic of the microcontroller design.

The connections marked 3 and 4 should not be used with the PICAXE system. These are used by the PICAXE chip as the 'serial in' and 'serial out' PC download connection.

The board is configured as supplied to use inputs 0 and 1 as analogue inputs. To use these inputs as digital inputs instead, or to provide a pull down resistor for the analogue potential divider, solder an appropriate resistor (e.g. 10k) into the positions marked R8 (input 0) and R7 (input 1).

Reset Switch

A small reset switch is provided on the board. If desired an external reset switch can be connected in parallel between the R input and G (ground, 0V).

Piezo Sounder (Chip Factory Systems Only)

The Chip Factory system automatically re-configures input 4 as a sound output. The piezo sounder should be connected between V1+ and input 4 for correct operation.

Connecting to the Project Boards

Inputs and outputs may be soldered via wires directly to the board. Alternately you may wish to purchase screw terminal blocks (5mm pitch) and solder these to the boards as shown below. This allows wires to be temporarily connected via the screw terminals.

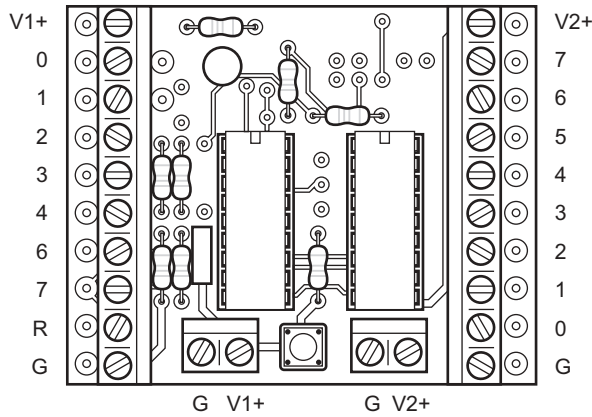

Note that when using terminal blocks it is necessary to 'share' the V2+ output with all output pins and to 'share' the V1+ output with all inputs.

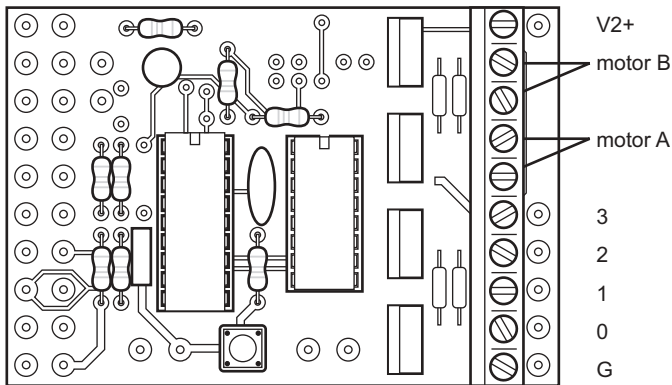

Appendix A - Adapting the board for use with the old PIC16F84A

The project board as supplied is configured for use with a PICAXE-18 or PIC16F627 using the internal resonator.

To modify the board for use with a PIC16F84A, or any other 18 pin microcontroller that requires an external resonator, the following modifications are required.

(Note that these changes apply to both boards, although the standard board is illustrated).

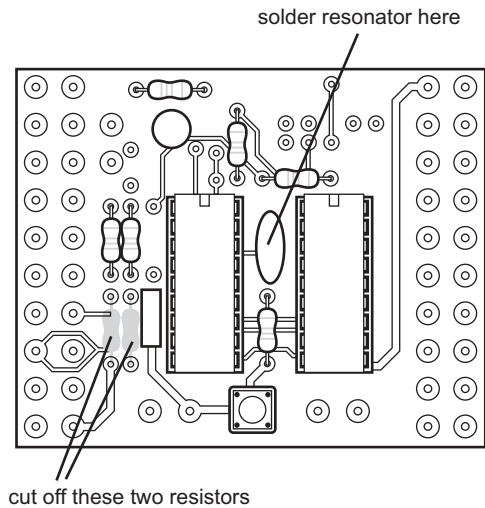

Cut off the two 10K resistors as shown.

Solder a 4MHz 3 pin ceramic resonator as shown.

No external connection should be made to inputs 6 and 7, as these are now the resonator pins.

In addition inputs 0 and 1 now become digital inputs (rather than analogue inputs as with the 16F627). This requires the addition of two extra 10k pull-down resistors as shown.

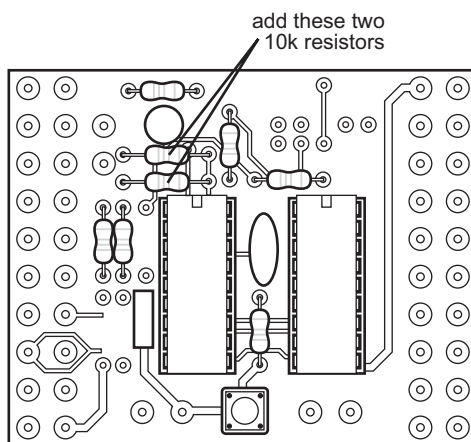

Appendix B - CHI030 Circuit Diagram

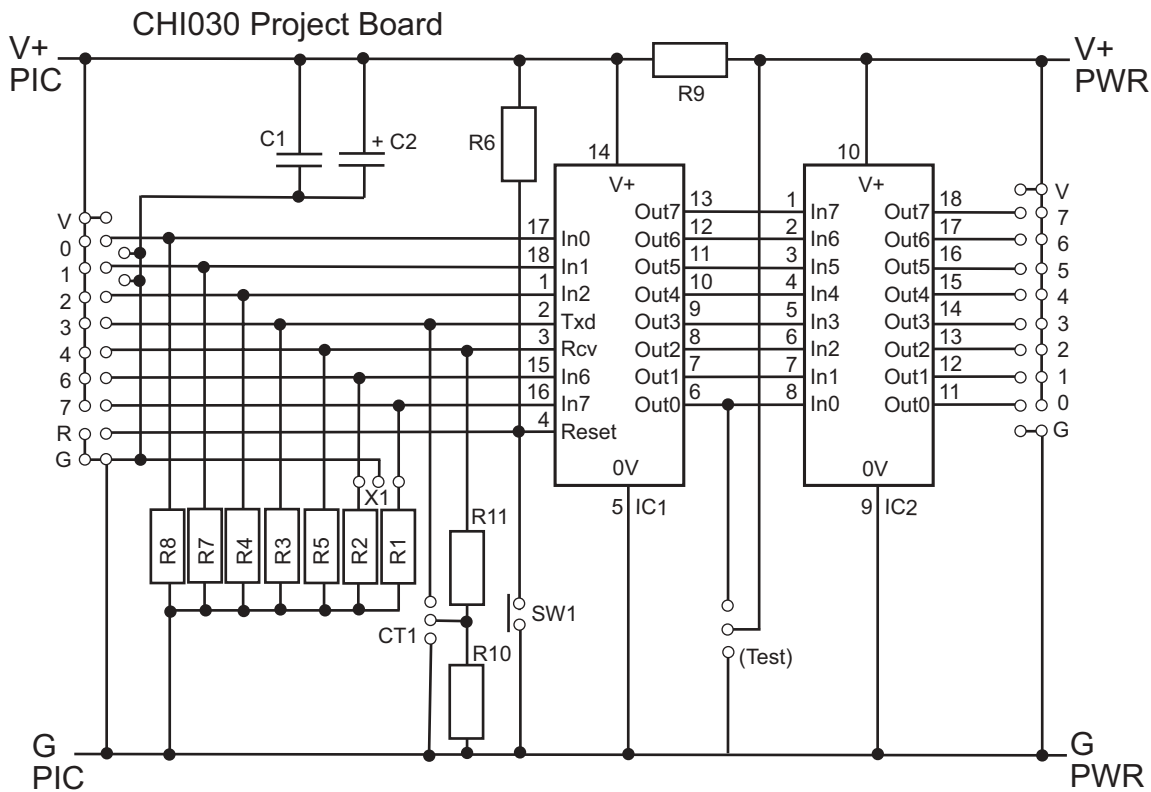

Appendix B - CHI030 / CHI035 Parts List

- R1-5, 7,8,10 10k resistor
 - R6 4k7 resistor
 - R9 100R resistor
 - R11 22k resistor
 - CT1 3.5mm stereo PICAXE download socket
 - SW1 minature reset switch
 - C1 100nF polyester
 - C2 100uF 16V electrolytic
 - IC1 PIC
 - IC2 ULN2803A (CHI030 only)
- Additional CHI035 parts*
- IC2 L293D (optional)
 - D1-4 1N4001 diode
 - Q1-4 IRF520 FET
 - C3-4 220nF polyester

Appendix D - CHI035 Circuit Diagram

The project board was initially designed for single power supply use when the L293D was used, and hence the L293D logic and main supply connections were not separated. At users request, these two connections will be modified on V3 of the board (see the text by FETs - will say 'PIC Interface B V2' or 'V3'). If desired (on V2 boards) the Vs pin (pin 8) can be separated by cutting the two tracks to pin8 and soldering V+ PIC to pin 9 and V+ PWR to pin 8.

