

# STC1001\_0 Mechanical Drawing

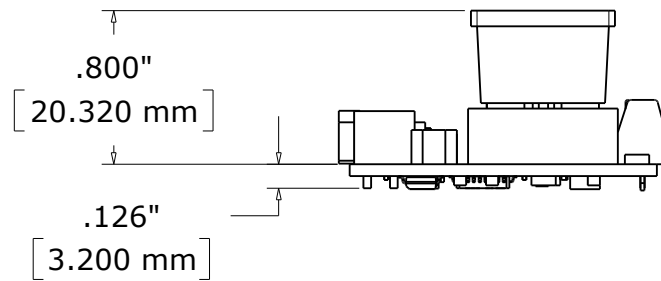

# STC1001\_0 Enclosure Mechanical Drawing

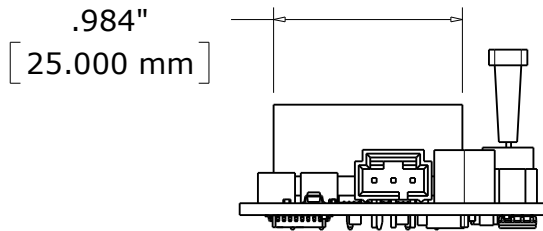
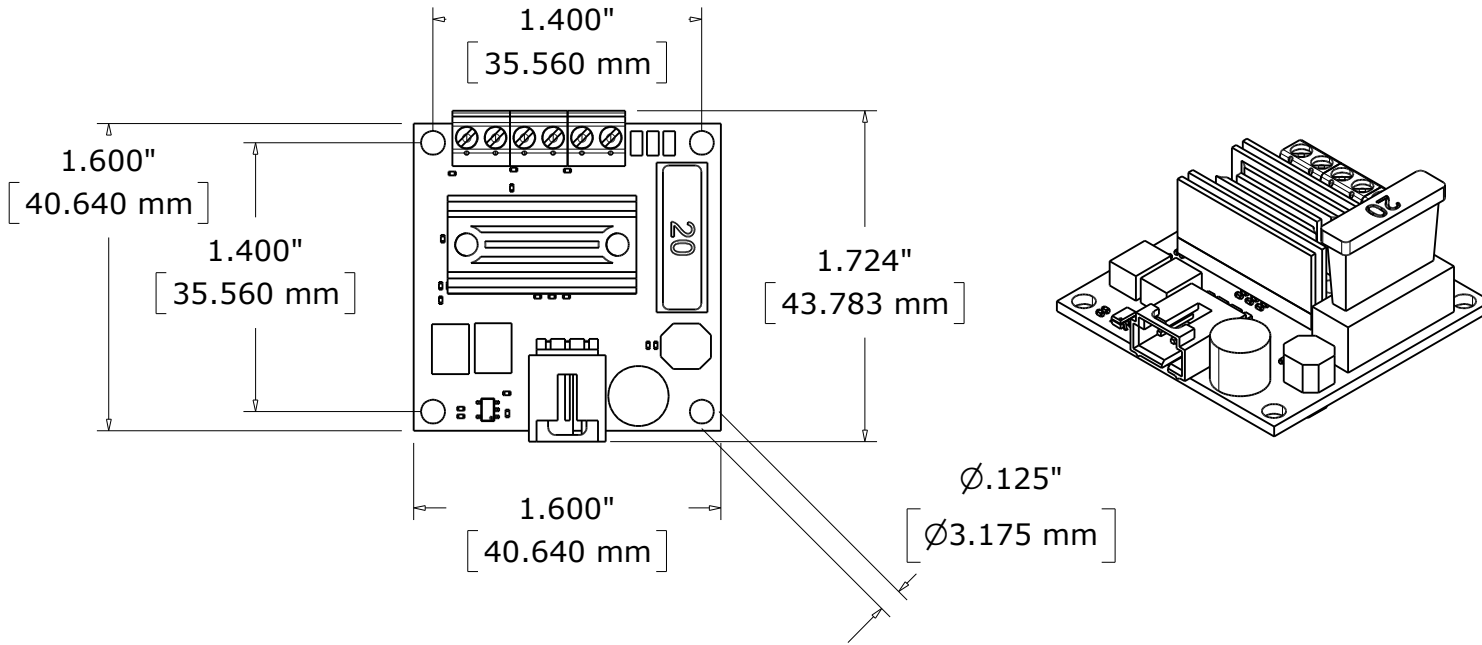