

# Phidget Enclosure Assembly Instructions

PN 3804 : Acrylic Enclosure for 1018 PhidgetInterfaceKit 8/8/8

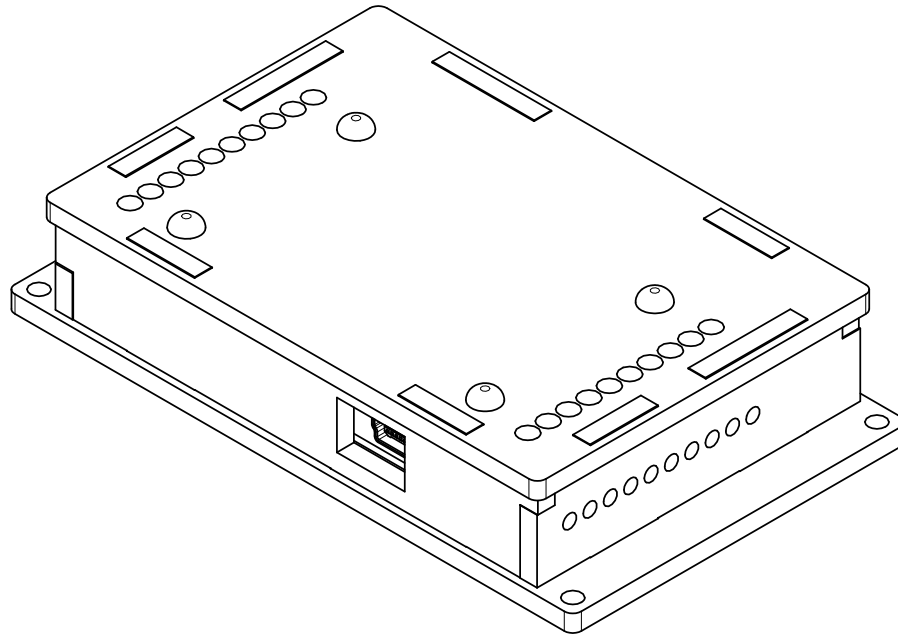

# Contents of Enclosure Kit

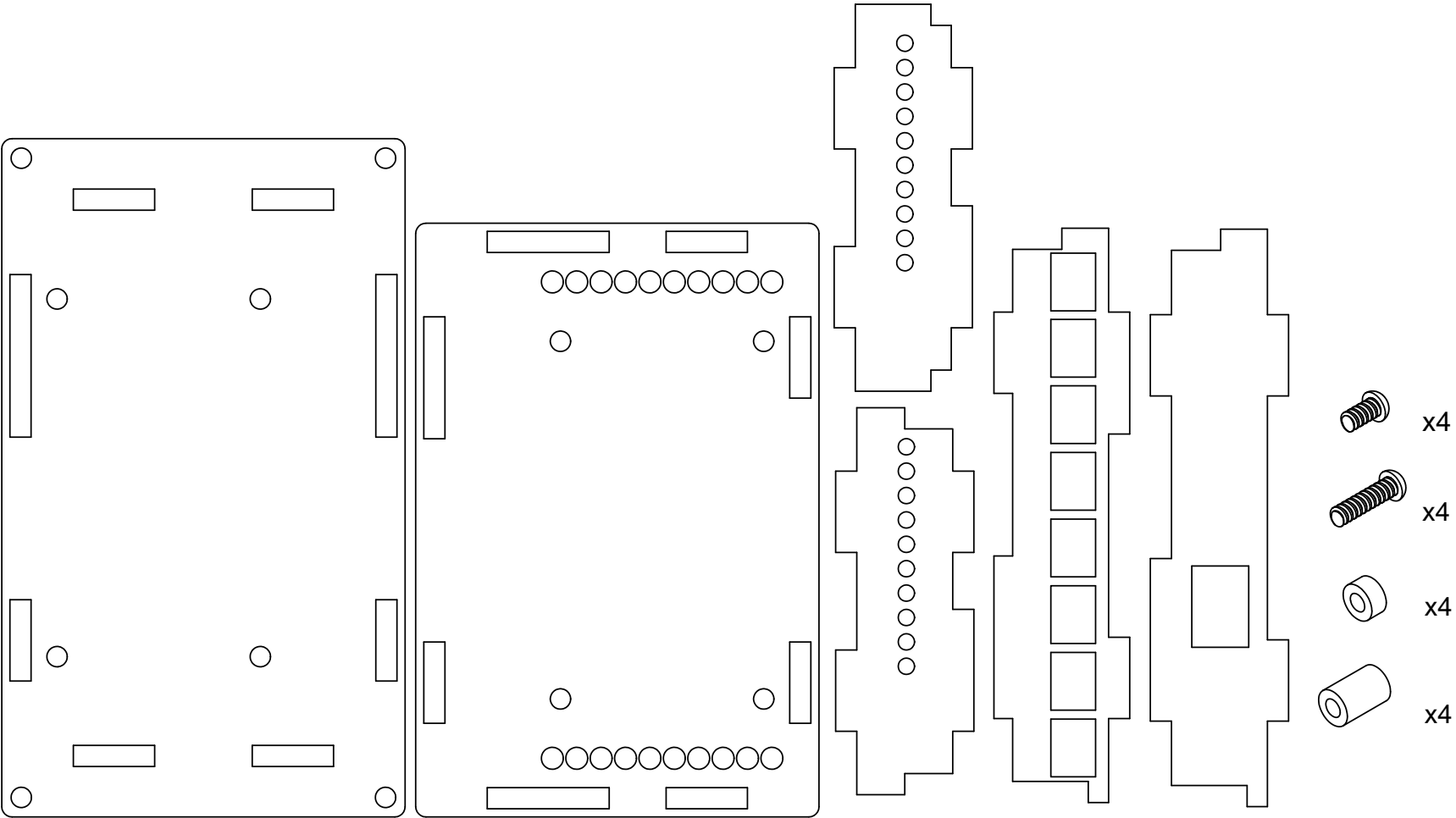

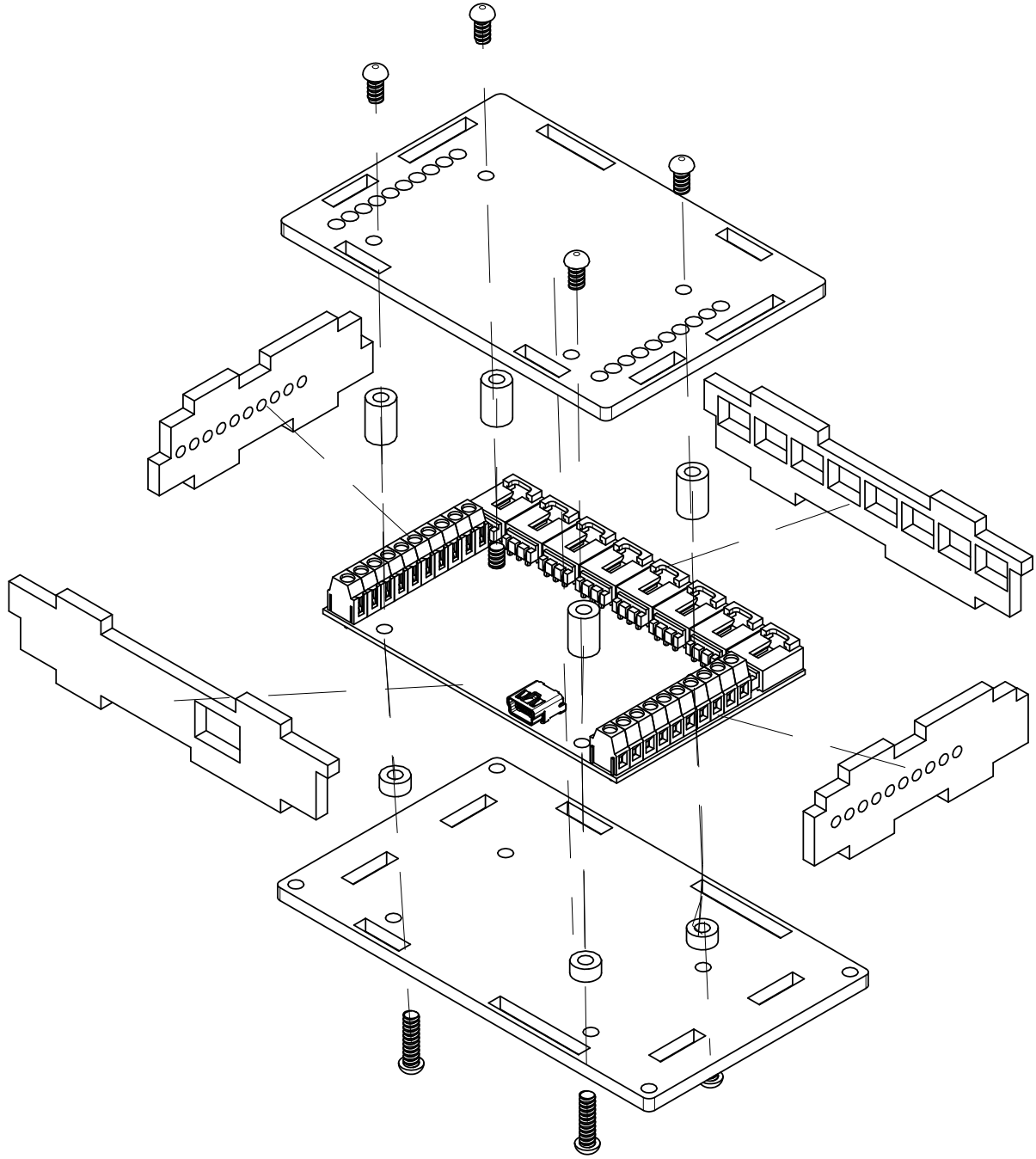

# Assembly Instructions

1

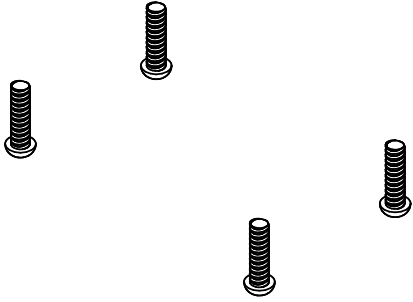

2

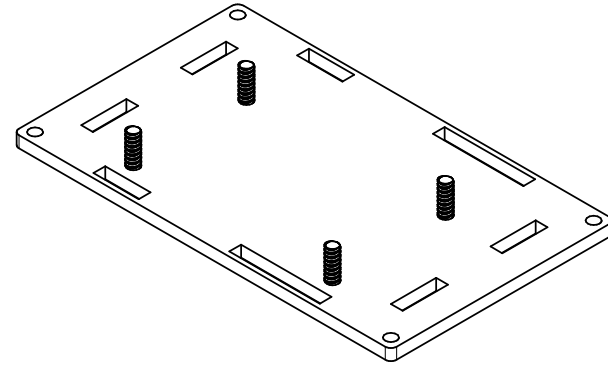

3

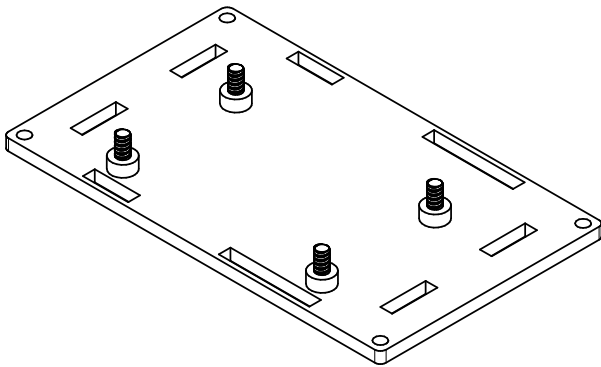

4

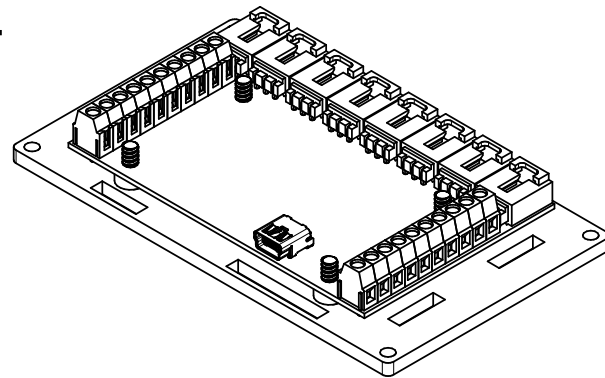

5

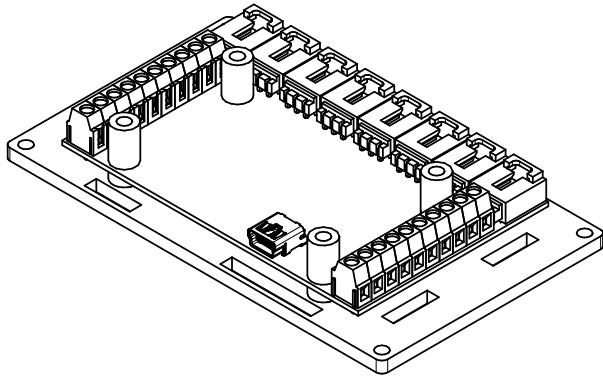

6

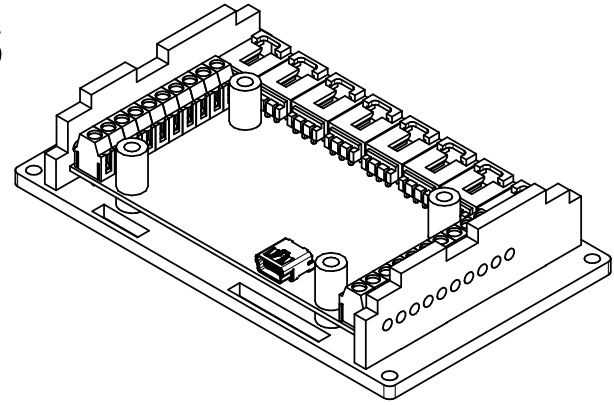

7

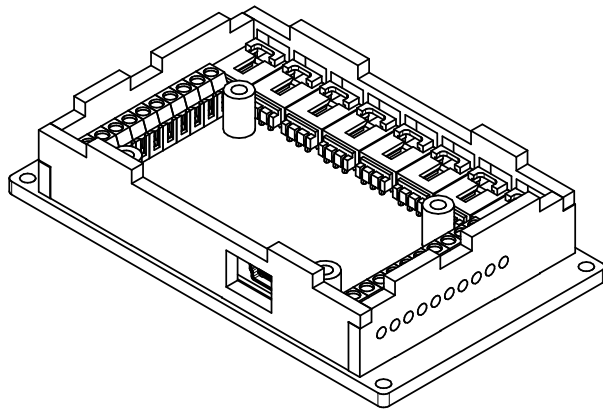

8

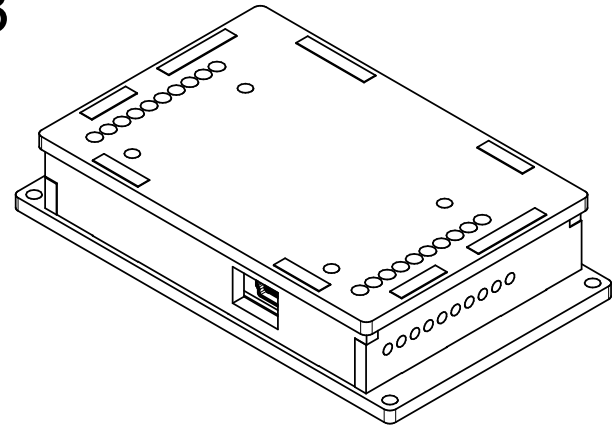

9

