



# Mini-ABB

## Atom Bot Board

for BASIC Atom, BASIC Atom-Pro,  
BS2, BS2-E, OOPic-C, BASICX-24

### Quick Start Guide

See the website for more information

Preliminary

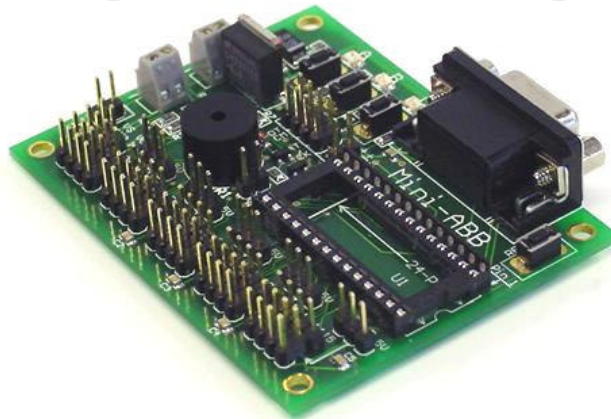

#### **Lynxmotion, Inc.**

PO Box 818  
Pekin, IL 61555-0818  
Tel: 309-382-1816 (Sales)  
Tel: 309-382-2760 (Support)  
Fax: 309-382-1254  
sales@lynxmotion.com  
tech@lynxmotion.com  
<http://www.lynxmotion.com>

Users Manual ABB-01 Ver 1.0

## Things that go Boom!



Caution! Read this quick start guide completely before wiring and applying power to the board! Errors in wiring can damage the Bot-Board, Hybrid microcontroller, and any attached peripherals.



Caution! Never reverse the power coming in to the board. Make sure the black wire goes to (-) ground, and the red wire goes to (+) Vlogic, or Vservo. Never connect peripherals when the board is powered on.



Caution! The onboard regulator can provide 250mA total. This includes the Hybrid microcontroller chip, the onboard LEDs, and any attached peripherals. Drawing too much current can cause the regulator to overheat.

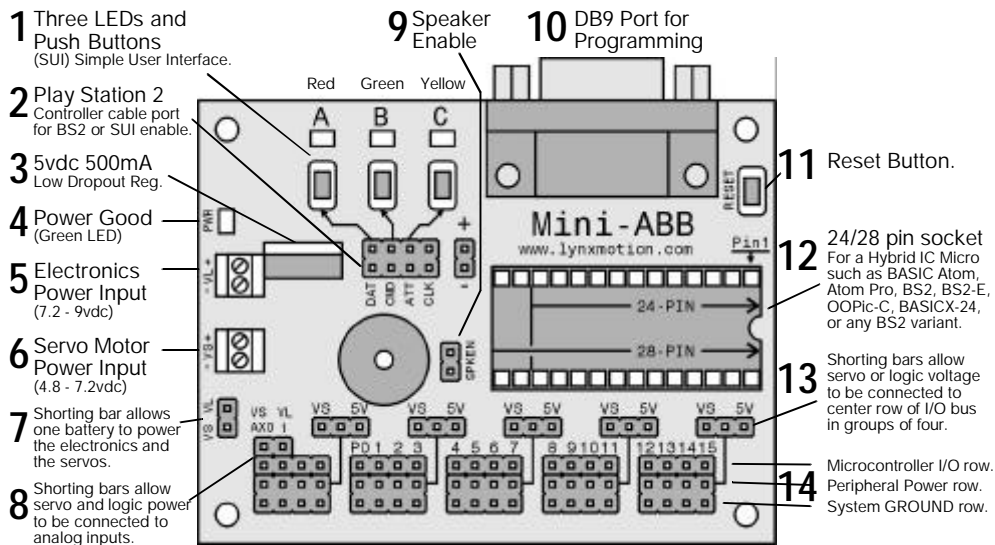

**1** The 3 LEDs and Pushbuttons use only 3 I/O lines to make a simple user interface for your program. By making the I/O line a low output the LED can be turned on. By briefly making the I/O line an input the I/O line can be read to see if a button is being pressed. However, do not make the I/O line a high output and press a button, as damage to the I/O pin can occur. The shorting bars will need to be installed for these LEDs and Pushbuttons to be used.

Chip I/O	PB/LED
Pin 4	A RED
Pin 5	B GREEN
Pin 6	C YELLOW

**2** This port is for connecting a Sony Playstation controller to use as a robot controller. This port is specific to the Basic Stamp 2, as it has an inverter built into the Clock signal. When using this port connect the PS2 cable as shown to the right. The Sony and Madcatz units we tested only required a 1K pullup on Pin 4, which is built into the board. Other brands may require a pullup on Pin 7, not included. When using the Atom or Atom-Pro you use the I/O bus, Pins 4 thru 7, as it does not use the inverter on the Clock line. Note, some wireless units will require the green wire be connected to 7.5vdc.

Chip I/O	PS2 cable
Pin 4	DAT Brown
Pin 5	CMD Orange
Pin 6	ATT Blue
Pin 7	CLK Black
*SrvPwr	+7.2 Green
5vdc	+ Yellow
GND	- Black

**3** The Low Dropout regulator will provide 5vdc out with as little as 5.5vdc coming in. This is important when operating your robot from a battery. It can accept a maximum of 9vdc in. The regulator is rated for 500mA, but we are de-rating it to 250mA to prevent the regulator from getting too hot.

\*Required to enable vibrating motors inside the controller, or for some wireless units.

**4** This is a Power Good LED. When you have successfully applied power to the onboard regulator the green LED will turn on.

**5** This is the Electronics Power Input. It is also referred to as the Logic Voltage, or VL. This input is normally used with a 9vdc battery connector to provide power to the Hybrid IC and anything connected to the 5vdc lines on the board. This input is used to isolate the logic from the Servo Power Input.

Board	Input
VL+	RED
VL-	BLACK

**6** This is the Servo Motor Power Input. It is also referred to as VS. It can be 4.8vdc to 7.2vdc. However, some micro servos will not tolerate more than 6vdc. This input is used to provide power for the servos only, or to provide power to both logic and servos (see 7).

Board	Input
VS+	RED
VS-	BLACK

**7** This allows you to power the Servos and Logic from the same battery. It simply connects the VS input to the VL input. Caution, when using this option do not use the VL input.

**8** This allows the VL and/or VS inputs to be connected to two of the Atom-28's analog inputs through a 4:1 voltage divider. For example, if the battery voltage were 9vdc the analog input would see 2.25vdc.

Chip I/O	V-Input
AX0	V-Servo
AX1	V-Logic

**9** This shorting bar enables the onboard speaker. To use the speaker, send the appropriate sound generating command to Pin 9. Note, the I/O pin does not drive the speaker directly, it just turns on a buffer transistor.

**10** Simply plug a straight-through M/F DB9 cable from this plug to a free 9 pin serial port on your PC for downloading programs and receiving debug info.

**11** This Pushbutton will reset the micro when pressed. This can be useful for starting a different program depending on which Pushbutton is pressed.

**12** This is where you plug in the Hybrid microcontroller. This can be an Atom, Atom-Pro, any Basic Stamp 2, the OOPic-C, BASICX-24, etc.

**13** This is where you configure the I/O bus center row to use VL (+5vdc from the onboard regulator) or VS (direct from the Servo Power Input). This is done in banks of four I/O pins. Caution, applying the servo voltage to this row with a 5vdc peripheral installed will cause damage to the peripheral.

**14** This is where you connect servos, motor controllers, sensors, etc. to the microcontroller. Use caution when connecting anything to the I/O bus. Never connect anything while the power is on.

### Shorting Bar Jumpers and Connectors at a glance

Applies +5vdc to the I/O bus.

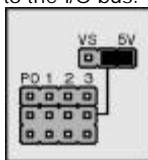

Applies VS to the I/O bus.

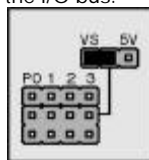

Applies VS and VL to analog inputs 0 and 1.

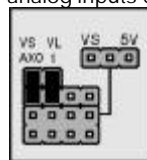

Enables the LEDs and Pushbuttons.

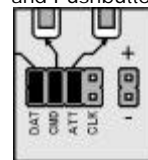

Example servo connection.

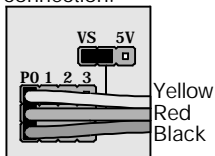

PlayStation 2 cable for Basic Atom.

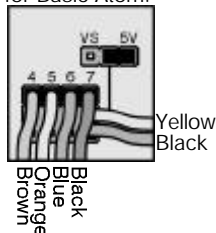

PlayStation 2 cable for Basic Stamp 2.

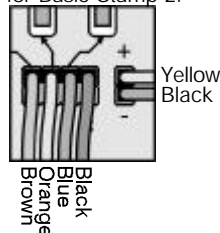

## 12 Servo Hexapod (Remote Control) Wiring Diagram

### How does it work?

Pushing the D-Pad buttons will make the robot walk forward, reverse, and turn in place left or right. Releasing the buttons will cause the robot to stop walking. Gradual turns can be done by pressing the intermediate buttons. By putting the controller into Analog Mode, you can use the left and right joysticks to steer the robot like a tank. You must hold the L1 or R1 button in order for the robot to walk in this mode. The robot's gait is proportional to the throw of the joysticks. The joysticks are sensitive, but with practice slow walking with gradual turns can be done. This is verified to work with MadCatz brand wireless controllers only!

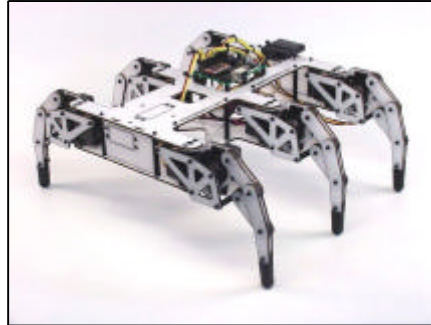

### Bot Board

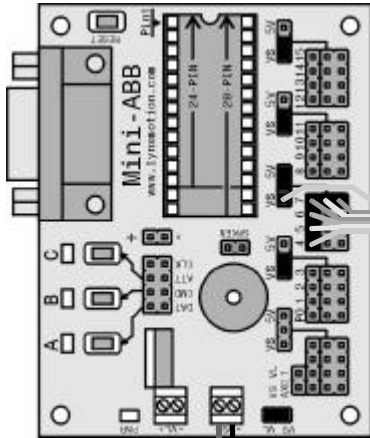

### Sony PS2 Controller Cable

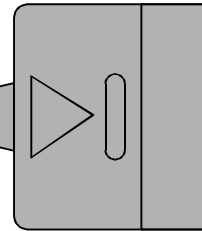

Chip I/O	PS2 cable
Pin 4	DAT Brown
Pin 5	CMD Orange
Pin 6	ATT Blue
Pin 7	CLK Black
*SrvPwr	+7.2 Green
5vdc	+ Yellow
GND	- Black

\*Required to enable vibrating motors inside the controller, or for some wireless units.

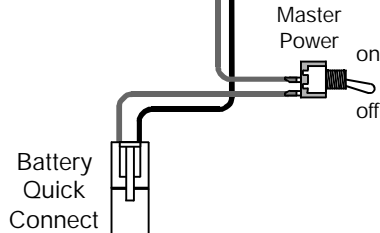

### Basic Atom-Pro required for this application.

This application takes advantage of the Basic Atom-Pro's HSERVO command to do the servo control in the background. It even does the walking sequences so the foreground program is completely free to concentrate on the behavior of the robot. This also eliminates the 20mS servo update timing constraint.

### Pin Leg

15	Left Front H
14	Left Front V
13	Right Front H
12	Right Front V
11	Left Middle H
10	Left Middle V
09	Right Middle H
08	Right Middle V
07	PS2 or LCD
06	PS2 or IRPD
05	PS2 or IRPD
04	PS2 or IRPD
03	Left Back H
02	Left Back V
01	Right Back H
00	Right Back V

## 12 Servo Hexapod (Autonomous) Wiring Diagram

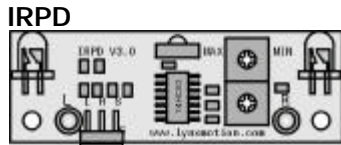

BLUE (L) = I/O 4  
 VIOLET (R) = I/O 5  
 YELLOW (S) = I/O 6  
 RED = +5VDC  
 BLACK = GROUND

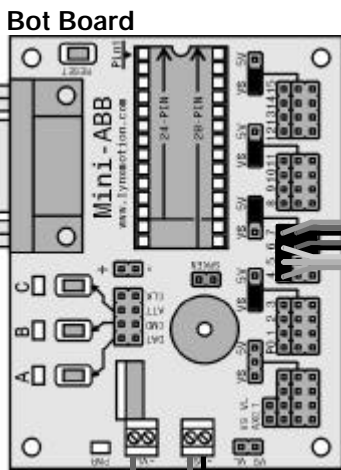
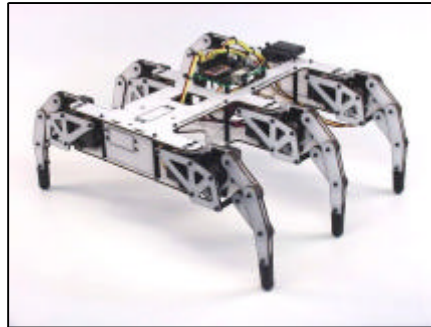

### Serial LCD (optional)

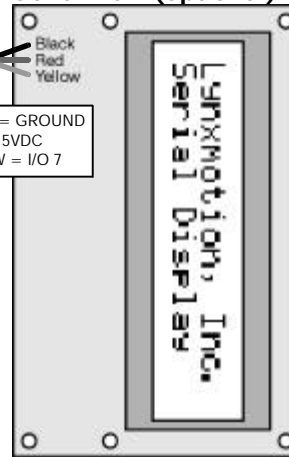

BLACK = GROUND  
 RED = +5VDC  
 YELLOW = I/O 7

Electronics Power

on

off

Servo Power

on

off

Battery  
 Quick  
 Connect

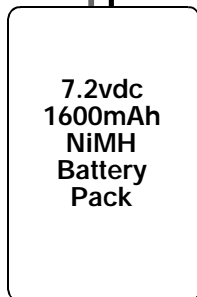

### Basic Atom-Pro required for this application.

This application takes advantage of the Basic Atom-Pro's HSERVO command to do the servo control in the background. It even does the walking sequences so the foreground program is completely free to concentrate on the behavior of the robot. This also eliminates the 20mS servo update timing constraint.

### Pin Leg

15	Left Front H
14	Left Front V
13	Right Front H
12	Right Front V
11	Left Middle H
10	Left Middle V
09	Right Middle H
08	Right Middle V
07	LCD
06	IRPD
05	IRPD
04	IRPD
03	Left Back H
02	Left Back V
01	Right Back H
00	Right Back V

### 3 Servo Hexapod Wiring Diagram

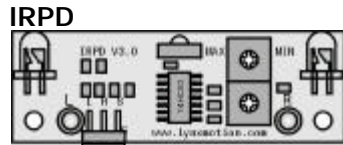

BLUE (L) = I/O 12  
 VIOLET (R) = I/O 13  
 YELLOW (S) = I/O 14  
 RED = +5VDC  
 BLACK = GROUND

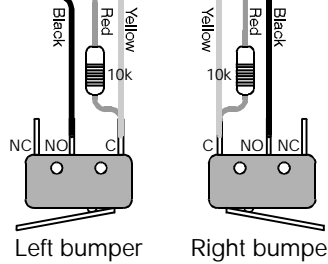
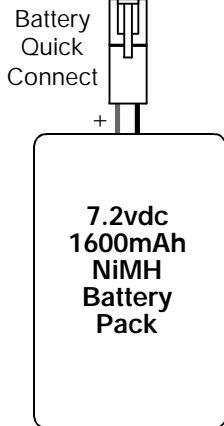
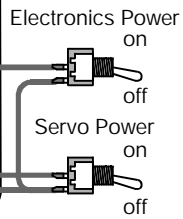
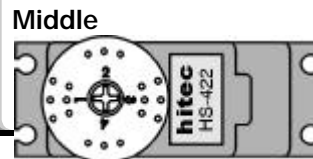
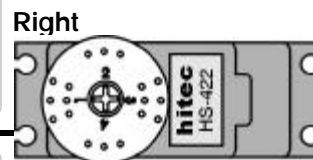
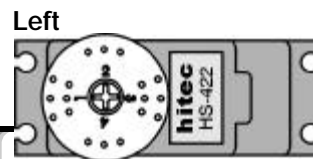
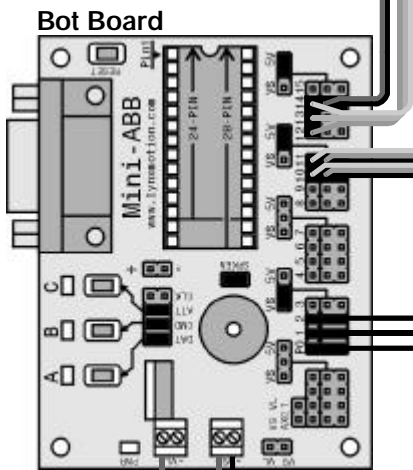

The bumper switches can be added as illustrated. The 10k pullup resistor will ensure the I/O pin will read as a high when the snap switch is not pushed in. The I/O pin will read a low when the bumper switch is pushed in.

## 2 Wheel Rover Wiring Diagram

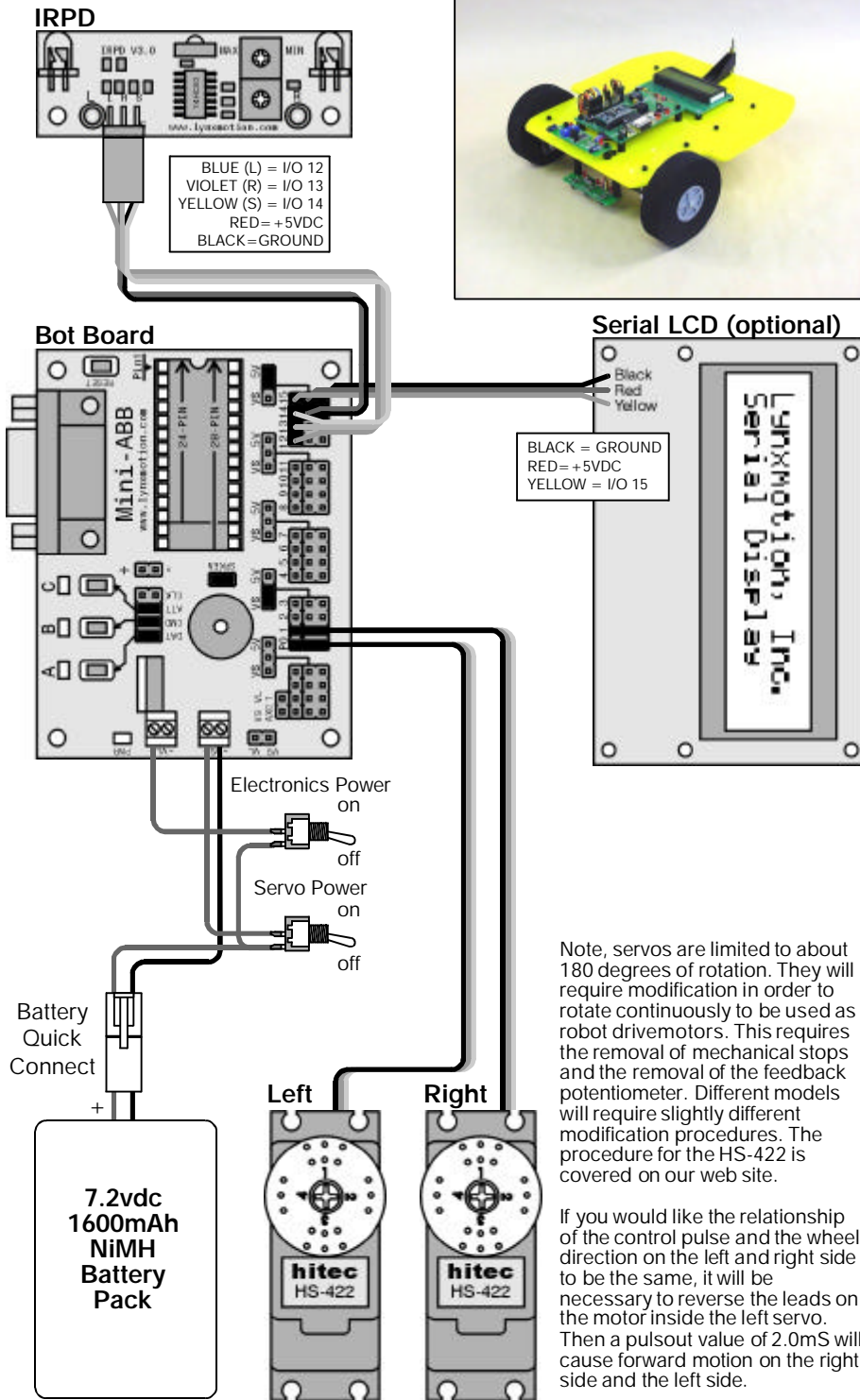

# 4 Wheel Rover Wiring Diagram

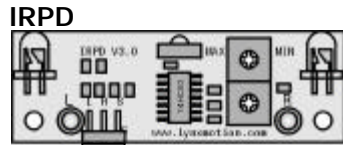

BLUE (L) = I/O 12  
 VIOLET (R) = I/O 13  
 YELLOW (S) = I/O 14  
 RED = +5VDC  
 BLACK = GROUND

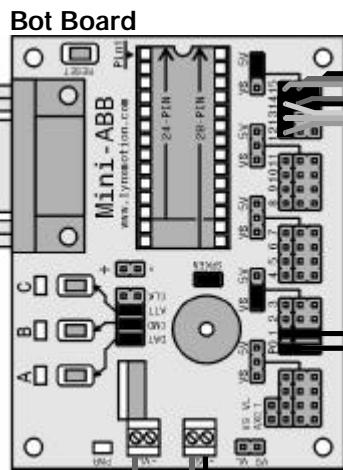
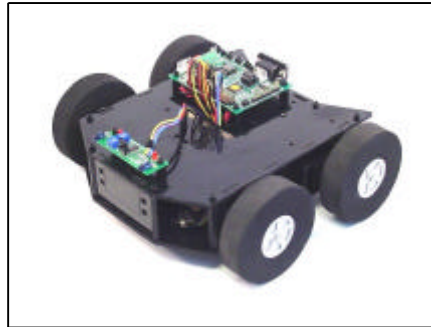

Serial LCD (optional)

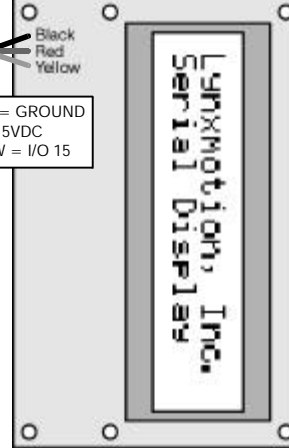

BLACK = GROUND  
 RED = +5VDC  
 YELLOW = I/O 15

Servo "Y" Cables

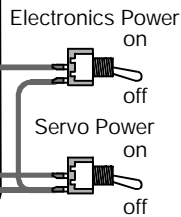

Battery Quick Connect

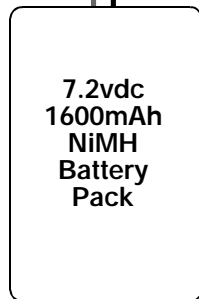

Left Pair

Right Pair

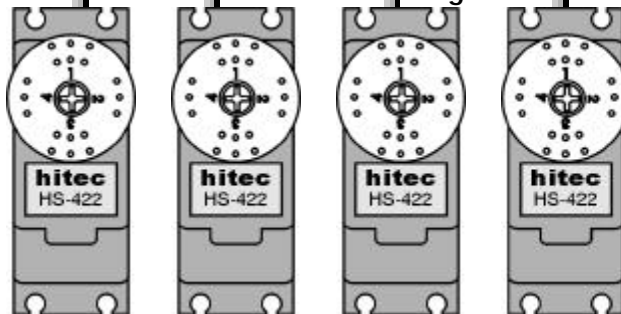



## Dual H-Bridge Rover Wiring Diagram

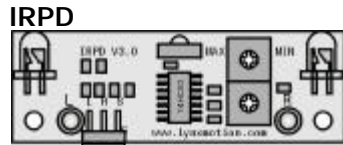

BLUE (L) = I/O 12  
 VIOLET (R) = I/O 13  
 YELLOW (S) = I/O 14  
 RED = +5VDC  
 BLACK = GROUND

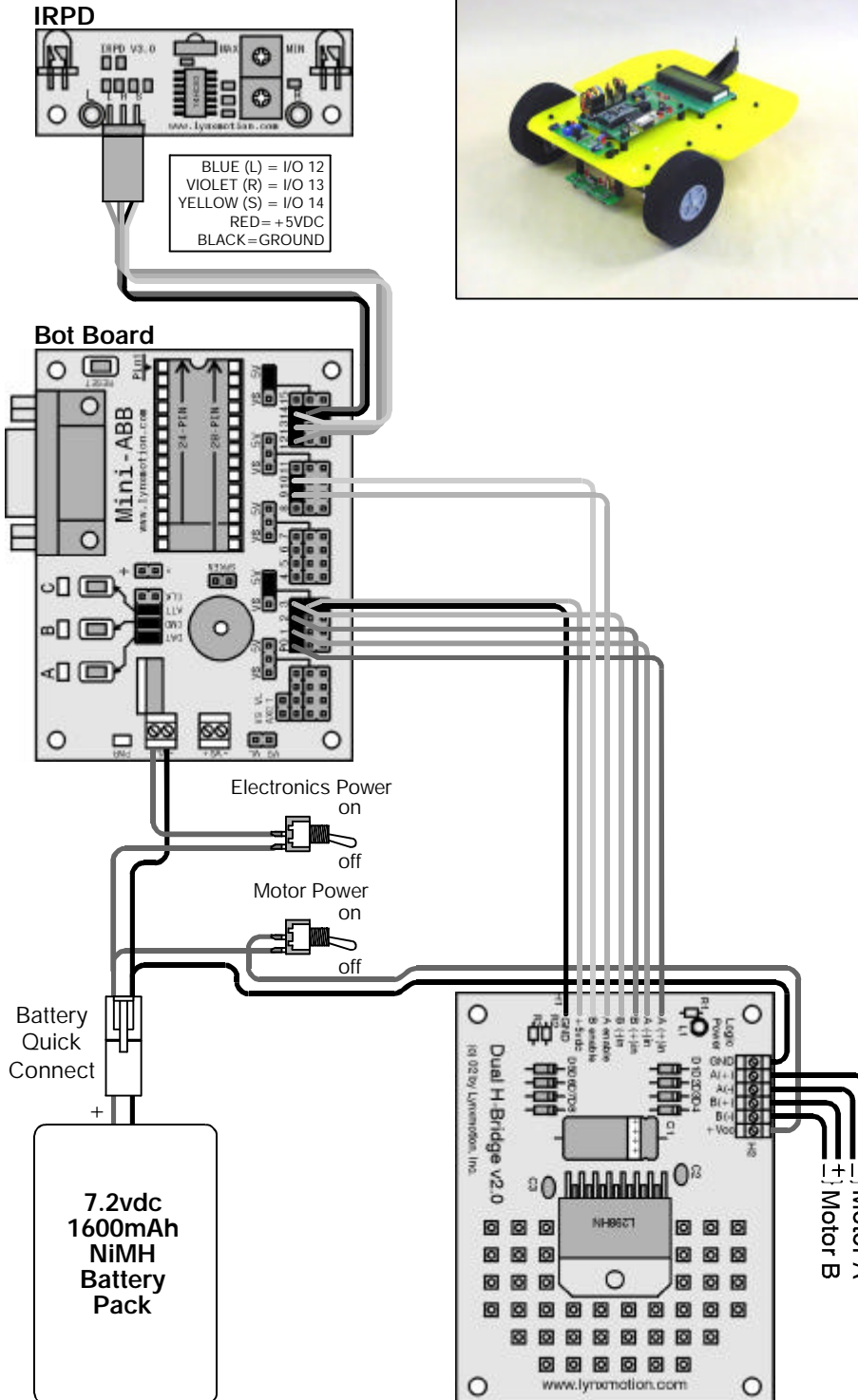
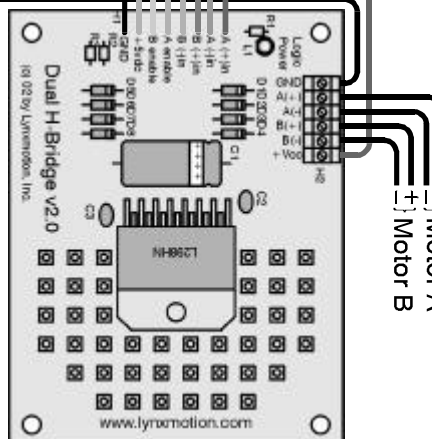
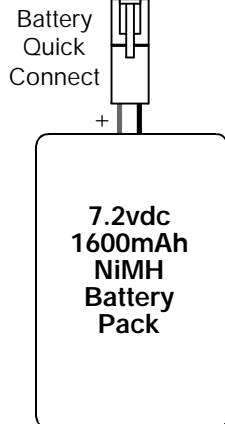
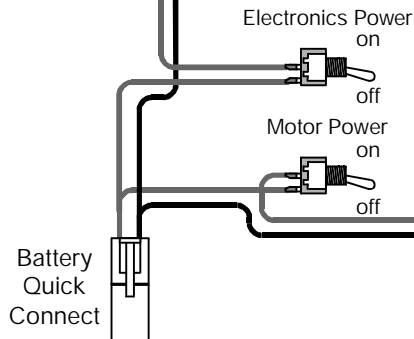
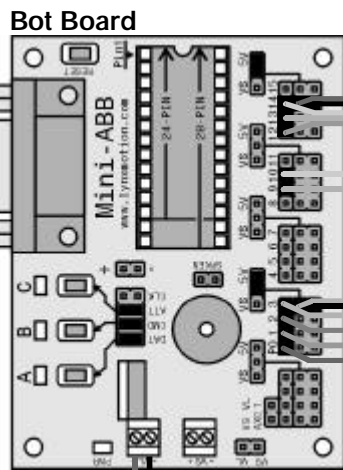
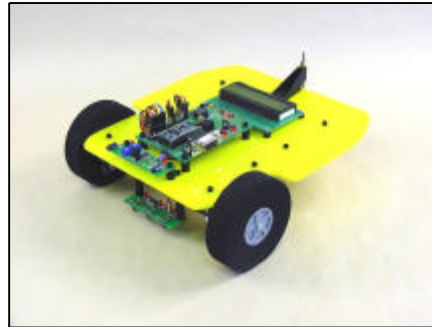

Copyright © 2004 by Lynxmotion, Inc.