

Miniature Linear Motion Series · L12

Firgelli Technologies' unique line of Miniature Linear Actuators enables a new generation of motion-enabled product designs, with capabilities that have never before been combined in a device of this size. These small linear actuators are a superior alternative to designing with awkward gears, motors, servos, and linkages.

Firgelli's L series of micro linear actuators combine the best features of our existing micro actuator families into a highly flexible, configurable, and compact platform with an optional sophisticated on-board microcontroller. The first member of the L series, the L12, is an axial design with a powerful drive-train and a rectangular cross section for increased rigidity. But by far the most attractive feature of this actuator is the broad spectrum of available configurations.



L12 Actuator – Actual Size

L12 Specifications

Gearing Option	50:1	100:1	210:1	
Peak Power Point	12N @ 11mm/s	23N @ 6mm/s	45N @ 2.5mm/s	
Peak Efficiency Point	6N @ 16mm/s	12N @ 8mm/s	18N @ 4mm/s	
Max Speed (<i>no load</i>)	23mm/s	12mm/s	5mm/s	
Max Force (<i>lifted</i>)	12N	23N	45N	
Back Drive Force (<i>static</i>)	20N	40N	80N	
Stroke Option	10 mm	30mm	50mm	100mm
Mass	28 g	34 g	40 g	56 g
Repeatability (-I,-R,-P&LAC)	±0.1 mm	±0.2 mm	±0.3 mm	±0.5 mm
Max Side Load (<i>extended</i>)	50N	40N	30N	15N
Closed Length (<i>hole to hole</i>)	62mm	82mm	102mm	152mm
Potentiometer (-I, -R, -P)	1kΩ±50%	3kΩ±50%	6kΩ±50%	11kΩ±50%
Voltage Option	6VDC	12VDC		
Max Input Voltage	7.5V	13.5V		
Stall Current	550mA	220mA		
Standby Current (-I/-R)	7.2mA	3.3mA		
Operating Temperature	-10°C to +50°C			
Potentiometer Linearity	Less than 2.00%			
Max Duty Cycle	20 %			
Audible Noise	55dB @ 45cm			
Ingress Protection	IP-54			
Mechanical Backlash	0.2mm			
Limit Switches (-S)	Max. Current Leakage: 8uA			
Maximum Static Force	200N			

1 - Control Option Specific values are identified with -I, -R, -P, -S, and LAC

2 - 1 N (Newton) = 0.225 lbf (pound-force)

3 - 25.4mm=1 Inch

4 - A powered-off actuator will statically hold a force up to the Backdrive Force

5 - Actuators should be tested in each specific application to determine their effective life under those loading conditions and environment.

All information provided on this datasheet is in accordance with our terms and conditions as posted here: <http://store.firgelli.com/terms.asp>

Benefits

- Compact
- Simple control
- Low voltage
- Equal push/pull
- Easy mounting

Applications

- Robotics
- Consumer appliances
- Toys
- RC vehicles
- Automotive
- Industrial Automation



Firgelli Technologies Inc.

580 Starling Lane
Victoria, BC, V9E 2A9
Canada

1 (206) 347-9684 phone
1 (888) 225-9198 toll-free
1 (206) 347-9684 fax

sales@firgelli.com
www.firgelli.com

L12 Specifications

Load Curves

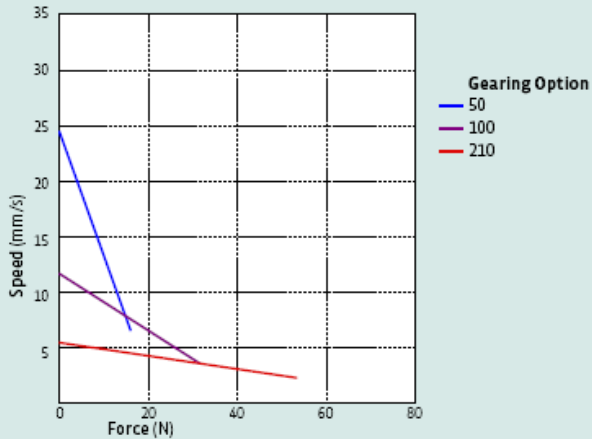

Current Curves

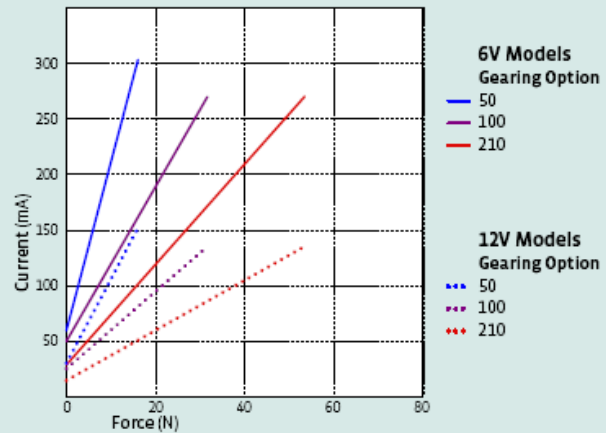

Model Selection

L12 options are identified according to the following scheme:

L12-SS-GG-VV-C

feature	Options
SS: Stroke Length	10, 30, 50, 100
GG: Gear reduction ratio (refer to load curves above)	50, 100, 210 (lower ratios are faster but push less force, and vice versa)
VV: Voltage	6, 12 (DC volts)
C: Controller	S Limit Switches P Potentiometer Feedback I Integrated Controller R RC Servo Integrated Controller

L12 Controller Options

Option S – End of Stroke Limit Switches

WIRING: (see last page for pin numbering)

- 1 - Red – Motor V+
- 2 - Black – Motor V- (Gnd)

The –S actuators have limit switches that will turn off power to the motor when the actuator reaches within 0.5mm of the end of stroke. Internal diodes allow the actuator to reverse away from the limit switch. The limit switches cannot be moved once the actuator is manufactured. While voltage is applied to the motor power pins, (1 & 2) the actuator extends. Reverse the polarity and the actuator retracts. This can be accomplished manually with a DPDT switch or relay, or using an H-Bridge circuit. The –S model cannot be used with the LAC control board.

Option P – Potentiometer Position Feedback

WIRING: (see last page for pin numbering)

- 1 - Orange – Feedback Potentiometer negative reference rail
- 2 - Purple – Feedback Potentiometer wiper
- 3 - Red – Motor V+ (6V or 12V)
- 4 - Black – Motor V- (Ground)
- 5 - Yellow – Feedback Potentiometer positive reference rail

The –P actuators have no built in controller, but do provide an analog position feedback signal that can be input to an external controller. While voltage is applied to the motor power pins, (3 & 4) the actuator extends. Reverse the polarity and the actuator retracts. This can be accomplished manually with a DPDT switch or relay, or using an H-Bridge circuit. Position of the actuator stroke can be monitored by providing any stable low and high reference voltage on pins 1 & 5, then reading the position signal on pin 2. The voltage on pin 2 will vary linearly between the two reference voltages in proportion to the position of the actuator stroke.

The L12 –P actuator can be used as a linear servo by connecting the actuator to an external controller such as the LAC board offered by Firgelli. This control board reads the position signal from the L12, compares it with your input control signal then commands the actuator to move via an on-board H-bridge circuit. The LAC allows any one of the following control inputs: Analog 0-5V or 4-20mA, or Digital 0-5V PWM, 1-2ms Standard RC, or USB. The RC input effectively transforms your L12 into a linear servo, which is a direct replacement for any common hobby servo used in RC toys and robotics. Refer to the LAC datasheet for more details.

Special Notes:

The L12 –B control option has been discontinued and replaced by the –S. The –S is a direct replacement requiring no changes to existing installations.



Firgelli Technologies Inc.

580 Starling Lane
Victoria, BC, V9E 2A9
Canada

1 (206) 347-9684 phone

1 (888) 225-9198 toll-free

1 (206) 347-9684 fax

sales@firgelli.com

www.firgelli.com

Option I – Integrated controller with industrial and RC servo interfaces

WIRING: (see last page for pin numbering)

- 1 - Green – **Current input signal** (4–20 mA interface mode)
- 2 - Blue – **Voltage input signal** (0–5V interface mode)
- 3 - Purple – **Position Feedback signal** (Proportional 0–3.3 V)
- 4 - White – **RC input signal** (RC-servo compatible mode)
- 5 - Red – **Power** (6V model or 12V model)
- 6 - Black – **Ground**

The –I actuator models feature an on-board software-based digital position controller. The controller is not user-programmable. The six lead wires are split into two connectors. Leads 4, 5 and 6 terminate at a universal RC servo three-pin connector (Hi-Tec™ and Futaba™ compatible). Leads 1, 2, and 3 terminate at a separate, similarly sized connector. When the actuator is powered up, it will repeatedly scan leads 1, 2, 4 for an input signal that is valid under any of the four supported interface modes. When a valid signal is detected, the actuator will self-configure to the corresponding interface mode, and all other interface modes and input leads are disabled until the actuator is next powered on.

0–5 V Interface Mode: This mode allows the actuator to be controlled with just a battery, and a potentiometer to signal the desired position to the actuator – a simple interface for prototypes or home automation projects. The desired actuator position (set point) is input to the actuator on lead 2 as a voltage between ground and 5 V. The set point voltage must be held on lead 2 even when the desired actuator stroke position is reached. Lead 2 is a high impedance input.

4–20 mA Interface Mode: This mode is compatible with PLC devices typically used in industrial control applications. The desired actuator position (set point) is input to the actuator on lead 1 as a current between 4 mA and 20 mA. The set point current must be held on lead 1 even when the desired actuator stroke position is reached.

RC Servo Interface Mode: This is a standard hobby-type remote-control digital servo interface (CMOS logic), compatible with servos and receivers from manufacturers like Futaba™ and Hi-Tec™. The desired actuator position is input to the actuator on lead 4 as a positive 5 Volt pulse width signal. A 1.0 ms pulse commands the controller to fully retract the actuator, and a 2.0 ms pulse signals full extension. If the motion of the actuator, or of other servos in your system, seems erratic, place a 1–4Ω resistor in series with the actuator’s red V+ lead wire.

PWM Mode: This mode allows control of the actuator using a single digital output pin from an external microcontroller. The desired actuator position is encoded as the duty cycle of a 5 Volt 1 kHz square wave on actuator lead 2, where the % duty cycle sets the actuator position to the same % of full stroke extension. The waveform must be 0V to +5V in order to access the full stroke range of the actuator.

Option R – RC Linear Servo

WIRING: (see last page for pin numbering)

- 1 - White – **RC input signal** (RC-servo compatible)
- 2 - Red – **Power** (+6 VDC)
- 3 - Black – **Ground**

Note: Reversing the polarity of pins 2 and 3 may permanently damage the actuator

The –R actuators or ‘linear servos’ are a direct replacement for regular radio controlled hobby servos. The desired actuator position is input to the actuator on lead 1 as a positive 5 Volt pulse width signal. A 1.0 ms pulse commands the controller to fully retract the actuator, and a 2.0 ms pulse signals it to fully extend. If the motion of the actuator, or of other servos in your system, seems erratic, place a 1–4Ω resistor in series with the actuator’s red V+ lead wire.

The –R actuators are available in 6 volt and 30, 50 and 100 mm strokes only.

This is a lower cost option for the RC hobby market. While the supported control options are reduced, the –R retains the same great precision and cycle life as the –I.

Ordering

Small quantity orders can be placed directly online at store.firgelli.com. Purchase orders, volume quotes, and custom requests can be sent to sales@firgelli.com.

Each actuator ships with two mounting brackets and #8-32 mounting hardware. The cable length is approximately 300mm and connector is a 0.1” pitch female socket connector.

Custom Options

Contact Firgelli for quotes and lead-times on any non-standard customizations. Minimum order quantity for customizations is 500 pieces.

Any modifications requiring mold changes will involve higher MOQ and/or NRE fees.



Firgelli Technologies Inc.

580 Starling Lane
Victoria, BC, V9E 2A9
Canada

1 (206) 347-9684 phone
1 (888) 225-9198 toll-free
1 (206) 347-9684 fax

sales@firgelli.com
www.firgelli.com

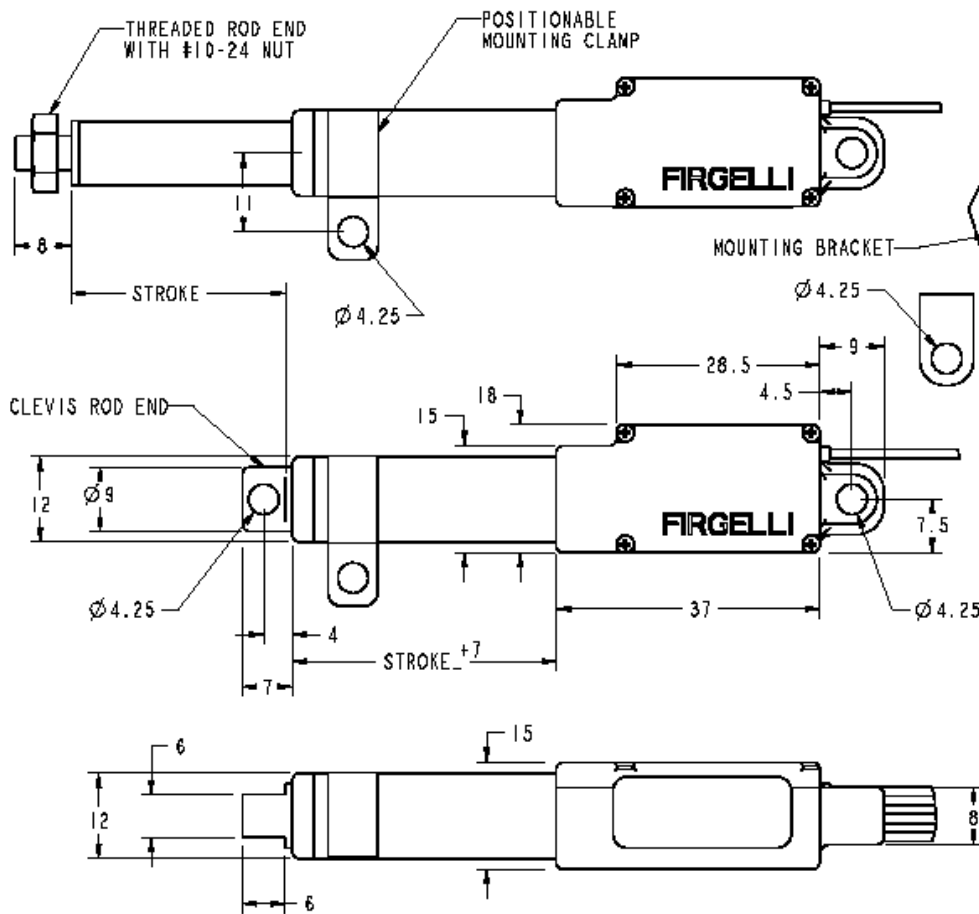

OPTION B & S

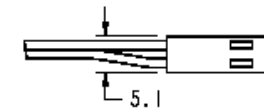

- 1. RED
- 2. BLACK

OPTION P

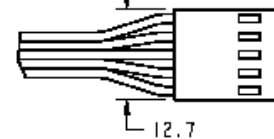

- 1. ORANGE
- 2. PURPLE
- 3. RED
- 4. BLACK
- 5. YELLOW

OPTION I

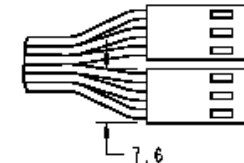

- 1. GREEN
- 2. BLUE
- 3. PURPLE
- 4. WHITE
- 5. RED
- 6. BLACK

OPTION R

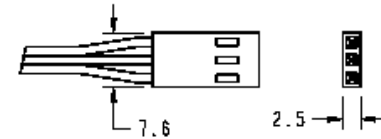

- 1. WHITE
- 2. RED
- 3. BLACK

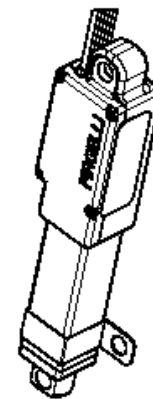

SCALE 1:1

NOTES:

- 1) WHEN CHANGING ROD ENDS, EXTEND ACTUATOR COMPLETELY AND HOLD THE ROUND SHAFT WHILE UNSCREWING THE ROD END PLUG
- 2) $\varnothing 4.25$ MOUNTING HOLES WILL FIT M4 OR UN #8 SIZE SCREWS
- 3) TWO MOUNTING CLAMPS, TWO MOUNTING BRACKETS, ONE EXTRA THREADED ROD END WITH NUT AND #8-32 HARDWARE, IS INCLUDED WITH EACH ACTUATOR.
- 4) STANDARD LEAD WIRE LENGTH IS 300mm. 28AWG STRANDED RIBBON WIRE. CONNECTORS ARE 2.54mm PITCH FEMALE HEADER CONNECTORS

FIRGELLI

L-12 ACTUATOR FAMILY INTERFACE DIMENSIONS

SIZE	SCALE	PART NUMBER	REV
B	3:2	10400	D
FILE L12-XX-10400		SHEET 1 OF 1	
DRAWN DATE: 9FEB07		DRAWN BY: M BAKER	
REV DATE: 20JAN08		CHECKED BY: R DICKSON	
INTERPRET DIMENSIONS AND TOLERANCES PER ASME Y14.5M-1994		THE INFORMATION CONTAINED HEREIN IS PROPRIETARY TO FIRGELLI AND IS TO BE USED BY THE RECIPIENT SOLELY FOR THE PURPOSE FOR WHICH IT IS SUPPLIED. IT SHALL NOT BE DISCLOSED, IN WHOLE OR IN PART, TO ANY OTHER PARTY WITHOUT THE PRIOR PERMISSION OF FIRGELLI.	
UNLESS NOTED OTHERWISE DIMENSIONS ARE IN MM TOLERANCES BELOW APPLY			
LINEAR	± 0.2	THIRD ANGLE PROJECTION	
ANGULAR	$\pm 5^\circ$		
SURFACE FINISH	1.6 MICRON		

Copyright 2015 © Firgelli Technologies Inc.



Firgelli Technologies Inc.

580 Starling Lane
Victoria, BC, V9E 2A9
Canada

1(206) 347-9684 phone
1(888) 225-9198 toll-free
1(206) 347-9684 fax

sales@firgelli.com
www.firgelli.com