



## Miniature Linear Motion Series · L16

Firgelli Technologies' unique line of Miniature Linear Actuators enables a new generation of motion-enabled product designs, with capabilities that have never before been combined in a device of this size. These linear actuators are a superior alternative to designing your own push/pull mechanisms.

The L16 actuators are complete, self contained linear motion devices with position feedback for sophisticated position control capabilities, end of stroke limit switches for simple two position automation, or RC servo. Several gear ratios are available to give you varied speed/force configurations.

### L16 Specifications

Gearing Option	35:1	63:1	150:1
Peak Power Point	50N @16mm/s	75N @10mm/s	175N @4mm/s
Peak Efficiency Point	24N @24mm/s	38N @15mm/s	75N @7mm/s
Max Speed (no load)	32mm/s	20mm/s	8mm/s
Max Force (lifted)	50N	100N	200N
Back Drive Force	31N	46N	102N
Stroke Option	50mm	100mm	140mm
Mass	56g	74g	84g
Repeatability (-P & LAC)	0.3mm	0.4mm	0.5mm
Max Side Load (extended)	40N	30N	20N
Closed Length (hole to hole)	118mm	168mm	218mm
Feedback Potentiometer	6kΩ±50%	11kΩ±50%	16kΩ±50%
Feedback Linearity	Less than 2.00%		
Input Voltage	0-15 VDC. Rated at 12VDC.		
Stall Current	650mA @ 12V		
Operating Temperature	-10°C to +50°C		
Audible Noise	60dB @ 45cm		
Ingress Protection	IP-54		
Mechanical Backlash	0.25mm		
Limit Switches	Max. Current Leakage: 8uA		
Maximum Static Force	250N		
Maximum Duty Cycle	20%		

### Basis of Operation

The L16 is designed to push or pull a load along its full stroke length. The speed of travel is determined by the load applied. (See the Load Curves). Actuator speed can be reduced by lowering the drive voltage. When power is removed the actuator will hold its position, unless the applied load exceeds the back drive force. Repeated stalling or stalling for more than a few seconds will shorten the life of the actuator significantly. Stalling is when an actuator is pushing a load that it cannot move. Actuators should be tested in each specific application to determine their effective life under those loading conditions and environment.

All data on this sheet is provided for information purposes only and is subject to change. Purchase and use of Firgelli Actuators is subject to our terms and condition as posted here: <http://store.firgelli.com/terms.asp>

### Applications

- Robotics
- Consumer appliances
- Toys
- RC vehicles
- Automotive
- Industrial Automation



### Firgelli Technologies Inc.

580 Starling Lane  
 Victoria, BC, V9E 2A9  
 Canada

1 (206) 347-9684 phone  
 1 (888) 225-9198 toll-free  
 1 (206) 347-9684 fax

sales@firgelli.com  
 www.firgelli.com

## L16 Specifications

Load Curves

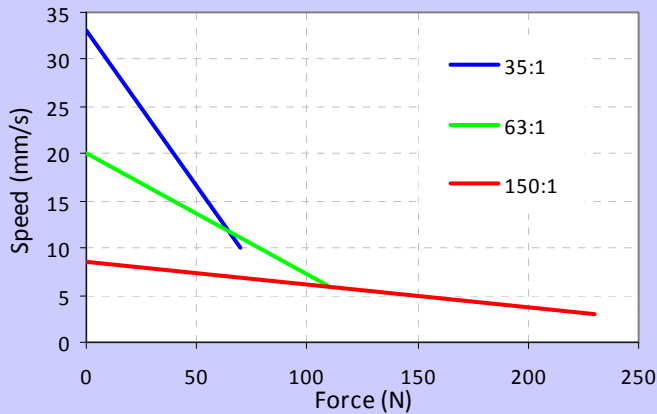

Current Curves

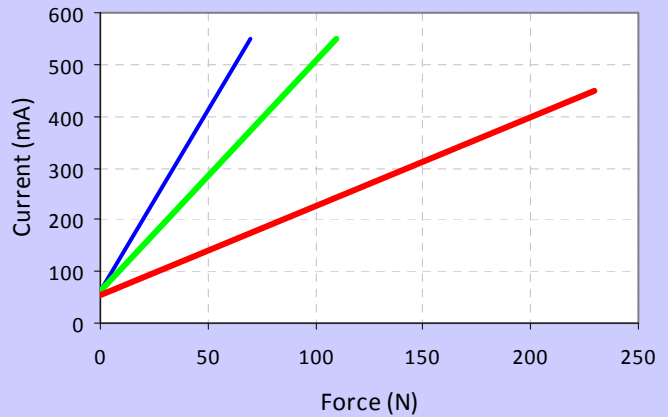

### Model Selection

The L16 has 3 configuration choices: Stroke, Gear Ratio and Controller. L16 options are identified according to the following model numbering scheme:

#### L16-SS-GG-VV-C

Feature	Options
<b>SS:</b> Stroke	<b>50, 100, 140 (mm)</b>
<b>GG:</b> Gear reduction ratio (refer to load curves above)	<b>35, 63, 150</b> (lower ratios are faster but push less force, and vice versa)
<b>VV:</b> Voltage	<b>12 vdc</b> or <b>6 vdc (-R only)</b>
<b>C:</b> Controller	<b>P</b> Potentiometer Feedback <b>S</b> Limit Switches <b>R</b> RC Linear Servo

### L16 Controller Options

#### Option S – End of Stroke Limit Switches

WIRING: (see last page for pin numbering)

- 1 - Red – Motor V+
- 2 – Black – Motor V- (Ground)

-S actuators are ideal for manually controlled applications and simple two position automated mechanisms. The -S actuators have limit switches that will turn off power to the motor when the actuator reaches within 0.5mm of the end of stroke. Internal diodes allow the actuator to reverse away from the limit switch. The limit switches cannot be moved once the actuator is manufactured. While voltage is applied to the motor power pins, (1 & 2) the actuator extends. Reverse the polarity and the actuator retracts. This can be accomplished manually with a DPDT switch or relay, or using an H-Bridge circuit. The -S model cannot be used with the LAC control board.

#### Option P – Potentiometer Position Feedback

WIRING: (see last page for pin numbering)

- 1 - Orange – Feedback Potentiometer negative reference rail
- 2 - Purple – Feedback Potentiometer wiper
- 3 - Red – Motor V+ (6V or 12V)
- 4 - Black – Motor V- (Ground)
- 5 - Yellow – Feedback Potentiometer positive reference rail

-P actuators are suited to automatically controlled positioning systems, but they can also be driven manually. The -P actuators have no built in controller, but do provide an analog position feedback signal that can be input to an external controller. While voltage is applied to the motor power pins, (3 & 4) the actuator extends. Reverse the polarity and the actuator retracts. This can be accomplished manually with a DPDT switch or relay, or using an H-Bridge circuit. Position of the actuator stroke can be monitored via the internal linear potentiometer. Provide any stable low and high reference voltage on pins 1 & 5, then read the position signal on pin 2. The voltage on pin 2 will vary linearly between the two reference voltages in proportion to the position of the actuator stroke.

The L16 -P actuator can be used as a linear servo by connecting the actuator to an external controller such as the LAC board offered by Firgelli. This control board reads the position signal from the L16, compares it with your input control signal then commands the actuator to move via an on-board H-bridge circuit. The LAC allows any one of the following control inputs: Analog 0-3.3V or 4-20mA, or Digital 0-5V PWM, 1-2ms Standard RC, or USB. The RC input effectively transforms your L16 into a linear servo, which is a direct replacement for any common hobby servo used in RC toys and robotics. Refer to the LAC datasheet for more details.



**Firgelli Technologies Inc.**

580 Starling Lane  
Victoria, BC, V9E 2A9  
Canada

1 (206) 347-9684 phone sales@firgelli.com  
1 (888) 225-9198 toll-free www.firgelli.com  
1 (206) 347-9684 fax

## Option R – RC Linear Servo

WIRING: (see last page for pin numbering)

- 1 - White – **RC input signal** (RC-servo compatible)
- 2 - Red – **Power** (+6 VDC)
- 3 - Black – **Ground**

*Note: Reversing the polarity of pins 2 and 3 may permanently damage the actuator*

-R actuators are ideally suited to use in robotics and radio control models. The -R actuators or 'linear servos' are a direct replacement for regular radio controlled hobby servos. The desired actuator position is input to the actuator on lead 1 as a positive 5 Volt pulse width signal. A 1.0 ms pulse commands the controller to fully retract the actuator, and a 2.0 ms pulse signals it to fully extend. If the motion of the actuator, or of other servos in your system, seems erratic, place a 1–4 $\Omega$  resistor in series with the actuator's red V+ lead wire.

L16 -R Linear Servos are the only 6 volt models in the L16 range because they are designed to work with typical RC receivers and battery packs. Consequently they also are compatible with Arduino control boards, VEX Microcontrollers and many other similar boards designed for robotics.

## Ordering

Small quantity orders can be placed directly online at [store.firgelli.com](http://store.firgelli.com). Purchase orders, volume quotes, and custom requests can be sent to [sales@firgelli.com](mailto:sales@firgelli.com).

Each actuator ships with two mounting brackets, #8-32 mounting hardware and male connector pins. The cable length is approximately 300mm and connector is a 0.1" pitch female socket connector.

## Custom Options

Contact Firgelli for quotes and lead-times on any non-standard customizations. Typically we can modify the stroke, limit switch positions, cable length and connector on a minimum order quantity of 500 pieces.

Any modifications requiring mold changes will involve higher MOQ and/or NRE fees.

## Accessories

Visit the [store.firgelli.com](http://store.firgelli.com) for compatible accessories including cable extensions, DPDT switches and relays, position indicators and power supplies.



### Firgelli Technologies Inc.

580 Starling Lane  
Victoria, BC, V9E 2A9  
Canada

1(206) 347-9684 *phone*  
1(888) 225-9198 *toll-free*  
1(206) 347-9684 *fax*

[sales@firgelli.com](mailto:sales@firgelli.com)  
[www.firgelli.com](http://www.firgelli.com)

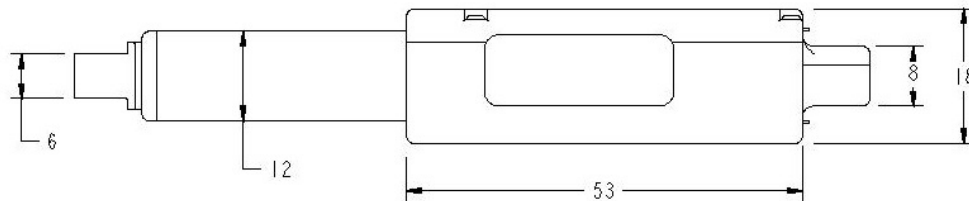
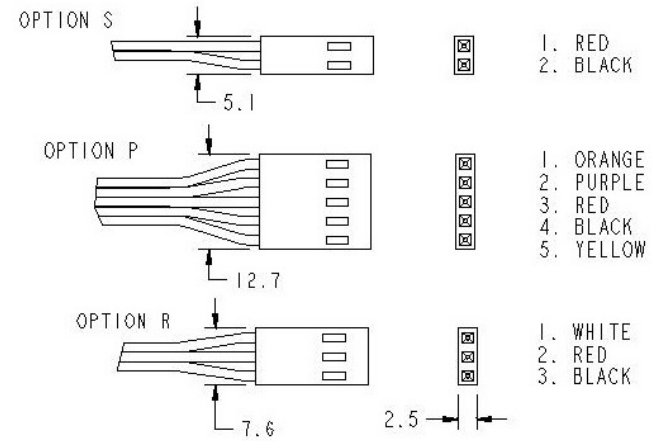
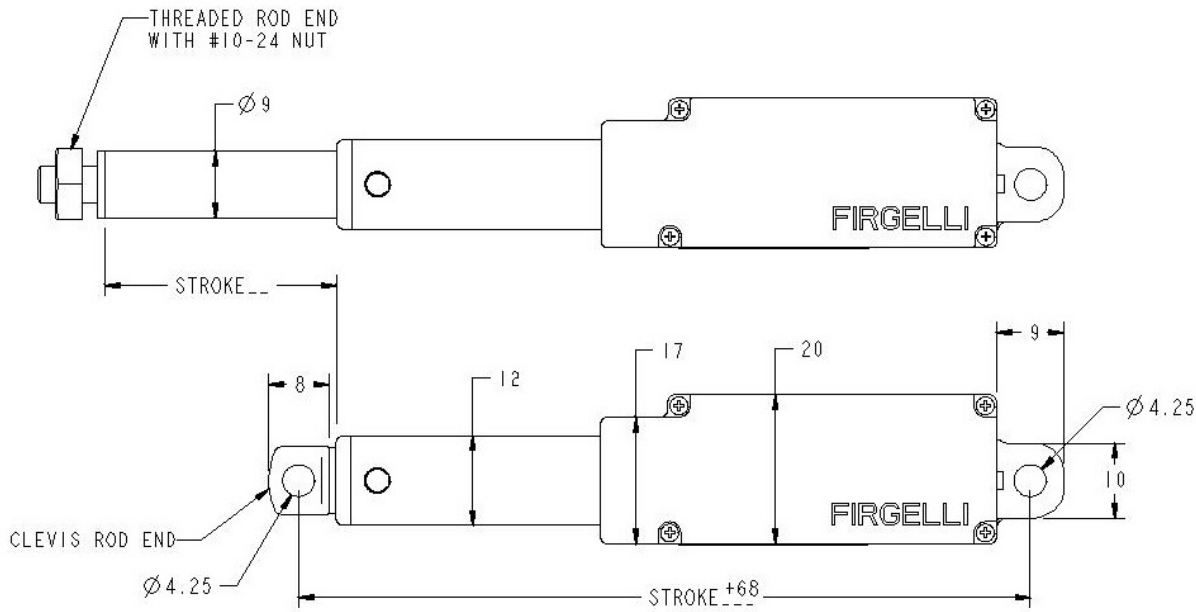

NOTES:

- 1) WHEN CHANGING ROD ENDS, EXTEND ACTUATOR COMPLETELY AND HOLD THE ROUND SHAFT WHILE UNSCREWING THE CLEVIS END PLUG, AND REPLACE THE NEW END WITH MAXIMUM TIGHTENING TORQUE OF 6 IN LBS.
- 2) Ø 4.25 MOUNTING HOLES WILL FIT M4 OR UN #8 SIZE SCREWS
- 3) TWO MOUNTING BRACKETS, ONE EXTRA THREADED ROD END WITH NUT AND #8-32 HARDWARE, IS INCLUDED WITH EACH ACTUATOR.
- 4) STANDARD LEAD WIRE LENGTH IS 300mm. 26AWG STRANDED RIBBON WIRE. CONNECTORS ARE 2.54mm PITCH FEMALE HEADER CONNECTORS

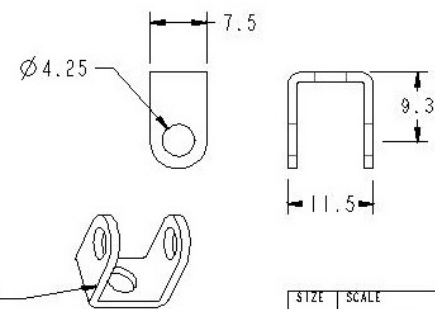

MOUNTING BRACKET

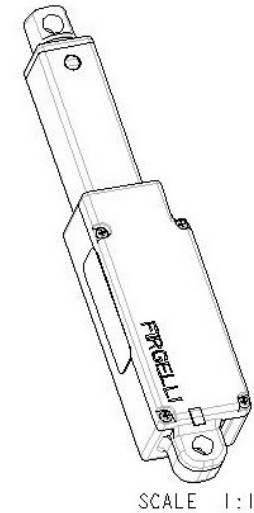

SIZE	SCALE	PART NUMBER	REV
B	3:2	L16	B
FILE	L16-XX_10500	SHEET 1	OF 1



**Firgelli Technologies Inc.**

580 Starling Lane  
Victoria, BC, V9E 2A9  
Canada

1 (206) 347-9684 phone  
1 (888) 225-9198 toll-free  
1 (206) 347-9684 fax

sales@firgelli.com  
www.firgelli.com

Copyright 2015 © Firgelli Technologies Inc.

All data on this sheet is provided for information purposes only and is subject to change. Purchase and use of Firgelli Actuators is subject to our terms and condition as posted here:

<http://store.firgelli.com/terms.asp>