

E-1608

16-Bit Multifunction Ethernet DAQ Device

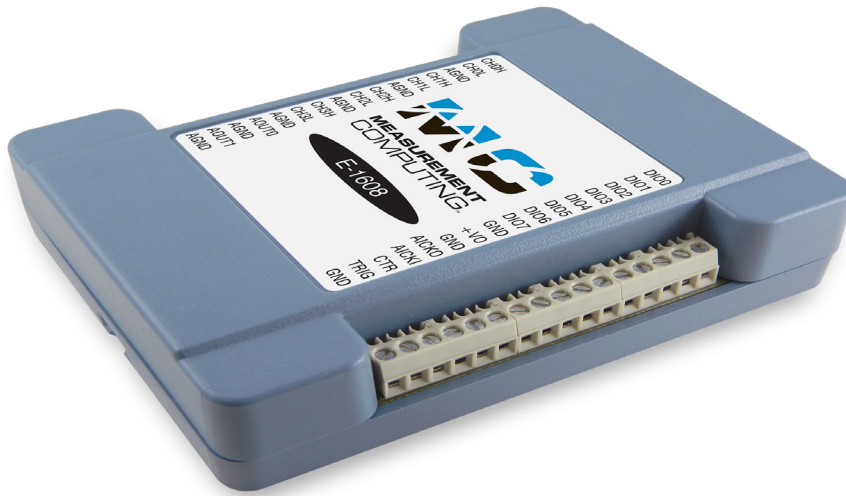

The E-1608 offers high-speed analog input over an Ethernet interface, two analog outputs, eight digital I/O, and one event counter input.

Overview

The E-1608 features a high-speed Ethernet interface that provides continuous real-time data transfers. The device offers four differential or eight single-ended analog inputs, and two analog outputs – all with 16-bit resolution. With eight digital I/O and one counter input, the E-1608 is a low-cost, high-performance multifunction I/O DAQ device.

Ethernet Interface

The E-1608 has a built-in 10/100 BASE-T auto-negotiation, high-speed communication port. The networking protocols are TCP/IP and UDP.

Once connected to the network, the device can be remotely accessed and configured through software from anywhere on the network. Only one user at a time can access the E-1608.

Software is required to actively communicate with the E-1608 over Ethernet. The device does not operate as a standalone data logger.

Analog Input

The E-1608 provides 16-bit analog inputs that are software-selectable as four DIFF or eight SE inputs. The device supports input ranges of ± 10 V, ± 5 V, ± 2 V, and ± 1 V that are software-selectable per channel.

Analog Output

The E-1608 has two 16-bit, software-paced analog outputs that can be updated at a rate of 500 S/s. The output range is fixed at ± 10 V.

Trigger Input

The E-1608 has an external digital trigger input. The trigger mode is software-selectable for edge- or level-sensitive mode. Edge-sensitive mode can be configured for either rising or falling edge. Level-sensitive mode can be configured for either high or low level. The default setting at power up is edge-sensitive, rising edge.

Digital I/O

Eight bidirectional digital I/O bits are individually-configurable for input or output. The digital I/O terminals can detect the state of any TTL-level input. Bits can be configured for pull-up ($+5$ V) or pull-down (0 V) with an onboard jumper.

Counter Input

One 32-bit event counter can count TTL pulses. The counter accepts inputs of up to 10 MHz.

Clock I/O

The E-1608 has one external clock input and one clock output for analog inputs.

Features

- High-speed Ethernet device
- Sample rates up to 250 kS/s
- 4 differential or 8 single-ended 16-bit analog inputs
- Two 16-bit analog outputs
- Eight digital I/O and one 32-bit counter input
- Includes CAT-6 Ethernet cable and 5 V power supply (required to provide external power)

Supported Operating Systems

- Windows 10/8/7/Vista® 32/64-bit
- Android™
- Linux®

Calibration

The E-1608 is factory-calibrated using a NIST-traceable calibration process. Specifications are guaranteed for one year. For calibration beyond one year, return the device to the factory for recalibration.

E-1608-OEM Version



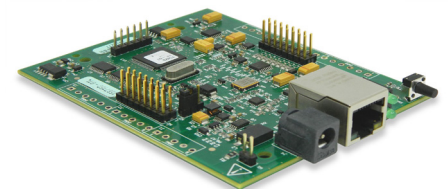

The E-1608-OEM has a board-only form factor with header connectors for OEM and embedded applications (no case or network cable included). All devices can be further customized to meet customer needs.



The E-1608-OEM has the same specifications as the standard device, but in a board-only form factor with header connectors instead of screw terminals.

Software Support

The E-1608 is supported by the software in the table below.

Ready-to-Run Applications		
DAQami™		<p>Data acquisition companion software with drag-and-drop interface that is used to acquire, view, and log data, and generate signals. DAQami can be configured to log analog, digital, and counter channels, and to view that data in real-time or post-acquisition on user-configurable displays. Logged data can be exported for use in Excel® or MATLAB®. Windows OS</p> <p>DAQami is included with the free MCC DAQ Software bundle. Install DAQami and try the fully-functional software for 30 days. After 30 days, all features except for data logging and data export will continue to be available – data logging and data export features can be unlocked by purchasing the software.</p>
InstaCal™		<p>An interactive installation, configuration, and test utility for MCC hardware. Windows OS</p> <p>InstaCal is included with the free MCC DAQ Software bundle.</p>
TracerDAQ™ and TracerDAQ Pro		<p>Virtual strip chart, oscilloscope, function generator, and rate generator applications used to generate, acquire, analyze, display, and export data. Supported features may vary by hardware. The Pro version provides enhanced features. Windows OS</p> <p>TracerDAQ is included with the free MCC DAQ Software bundle.</p> <p>TracerDAQ Pro is available as a purchased software download.</p>
General-Purpose Programming Support		
Universal Library™ (UL) for Windows		<p>Library for developing applications in C, C++, VB, C# .Net, VB .Net, and Python on Windows. The UL for Windows is included with the free MCC DAQ Software bundle. The UL Python API for Windows is available on GitHub (https://github.com/mccdaq/mcculw).</p>
UL for Android™		<p>Programming library of Java classes for programmers who develop apps for Android-based tablets and phones. UL for Android communicates with select MCC DAQ devices. Supports Android project development on Windows, Linux, Mac OS X</p> <p>UL for Android is included with the free MCC DAQ Software bundle.</p>
UL for Linux®		<p>Library for developing applications in C, C++, and Python on Linux.</p> <p>UL for Linux is available on GitHub (https://github.com/mccdaq/uldaq).</p> <p>Open-source, third-party Linux drivers are also available for supported MCC devices.</p>
Application-Specific Programming Support		
ULx for NI LabVIEW™		<p>A comprehensive library of VIs and example programs for NI LabVIEW that is used to develop custom applications that interact with most MCC devices. Windows OS</p> <p>ULx for NI LabVIEW is included with the free MCC DAQ Software bundle.</p>
DASYLab®		<p>Icon-based data acquisition, graphics, control, and analysis software that allows users to create complex applications in minimal time without text-based programming. Windows OS</p> <p>DASYLab is available as a purchased software download. An evaluation version is available for 28 days.</p>

E-1608 Block Diagram

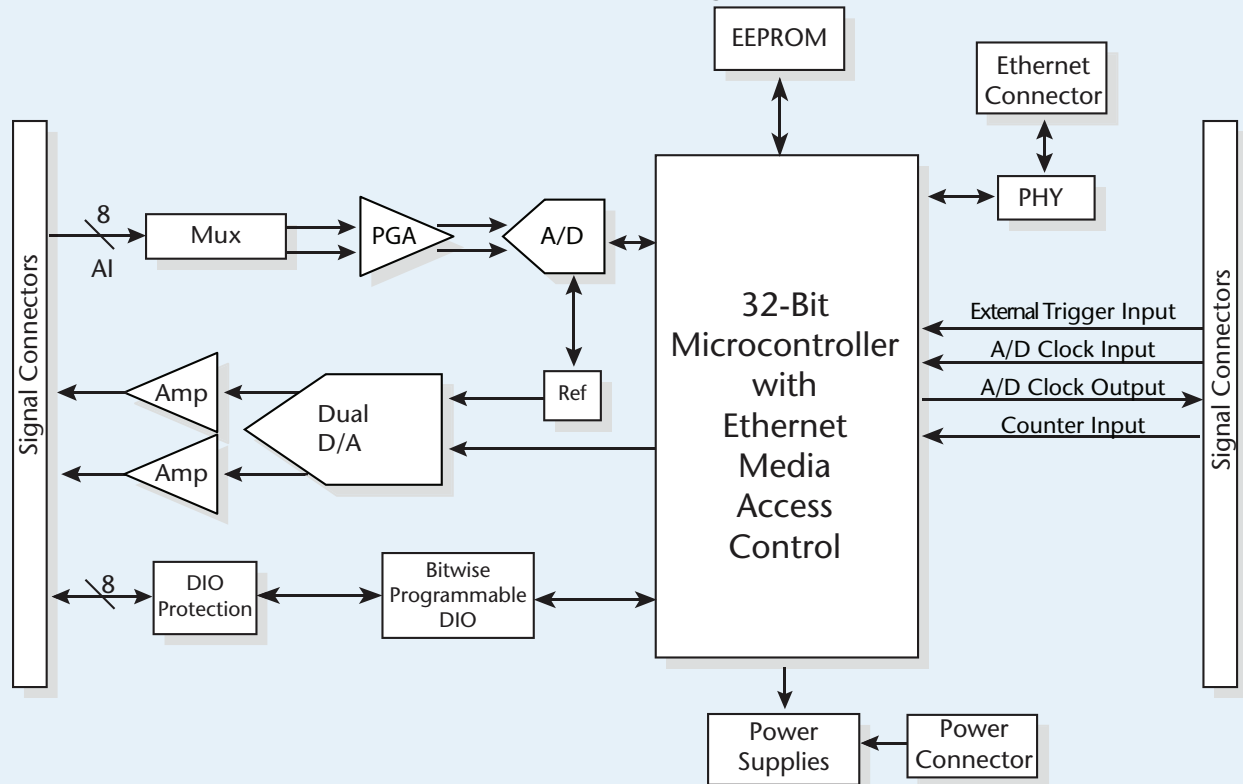

Specifications

All specifications are subject to change without notice.
Typical for 25 °C unless otherwise specified.
These specifications apply to both standard and OEM versions unless otherwise specified.

Analog Input

A/D converter type: Successive approximation
ADC resolution: 16 bits
Number of channels: 4 differential, 8 single-ended (software-selectable)
Input voltage range: ±10 V, ±5 V, ±2 V, ±1 V (software-selectable per channel)
Absolute max input voltage (CHx relative to AGND): ±20 V max (power on), ±12 V max (power off)
Input impedance: 1 GΩ (power on), 1200 Ω (power off)
Input bias current: ±10 nA
Input bandwidth (all input ranges, small signal (-3 dB)): 700 kHz
Input capacitance: 60 pF
Max working voltage (signal + common mode)
 ±10 V range: ±10.2 V max relative to AGND
 ±5 V range: ±10.2 V max relative to AGND
 ±2 V range: ±9.5 V max relative to AGND
 ±1 V range: ±9.0 V max relative to AGND
Common mode rejection ratio ($f_N = 60$ Hz, all input ranges): 86 dB
Crosstalk (adjacent differential mode channels, DC to 10 kHz): -75 dB
Input coupling: DC

Sample rate: 0.019 Hz to 250 kHz, software-selectable
Trigger source: TRIG (see [External Trigger](#))
Sample clock source: Internal A/D clock or external A/D clock (AICKI pin)
Internal sample clock stability: ±50 ppm
Internal sample clock timebase: 80 MHz timer with 32-bit period (available frequencies are 80 MHz / integer period)
Throughput
 This is the typical throughput when the device and host are both connected by Ethernet to the same local network. The throughput can vary significantly if a wireless connection is involved or data is sent over the internet and is not guaranteed
Software paced: 1000 S/s to 5000 S/s typ, on local network
Hardware paced: 250 kS/s max
Channel gain queue (up to 8 elements): Software-selectable channel and range for each queue element
Warm-up time: 15 minutes min

Analog Input DC Voltage Measurement Accuracy (All Values are (±))						
Range	Gain Error (% of Reading)	Offset Error	INL Error (% of Range)	Absolute Accuracy at Full Scale	Gain Temperature Coefficient (% Reading/°C)	Offset Temperature Coefficient
±10 V	0.024	915 µV	0.0076	4075 µV	0.0014	47 µV/°C
±5 V	0.024	686 µV	0.0076	2266 µV	0.0014	24 µV/°C
±2 V	0.024	336 µV	0.0076	968 µV	0.0014	10 µV/°C
±1 V	0.024	245 µV	0.0076	561 µV	0.0014	5 µV/°C

Noise Performance		
Range	Counts	LSBrms
±10 V	6	0.91
±5 V	6	0.91
±2 V	7	1.06
±1 V	9	1.36

For the peak-to-peak noise distribution test, a differential input channel is connected to AGND at the input terminal block, and 16384 samples are acquired at the maximum rate available at each setting.

Settling Time			
Range	4 µs Settling Accuracy (% FSR)	6 µs Settling Accuracy (% FSR)	10 µs Settling Accuracy (% FSR)
±10 V	0.0061	0.0031	0.0015
±5 V	0.0061	0.0031	0.0015
±2 V	0.0061	0.0031	0.0015
±1 V	0.0061	0.0031	0.0015

Settling time is defined as the accuracy that can be expected after one conversion when switching from a channel with a DC input at one extreme of full scale to another channel with a DC input at the other extreme of full scale. Both input channels are configured for the same input range.

Analog Output

Number of channels: 2

Resolution: 16 bits

Output ranges (calibrated): ±10 V

Output transient

Powered on

Duration: 5 ms

Amplitude: 2 V p-p

Powered off

Duration: 400 ms

Amplitude: 10 V p-p

Differential nonlinearity (16-bit monotonic): ±0.35 LSB typ, ±1 LSB max

Output current (AOUTx pins): ±3.5 mA max; leave unused AOUTx output channels disconnected

Output coupling: DC

Power on and reset state: DACs cleared to uncalibrated zero-scale: 0 V, ±50 mV unless the alarm function is enabled for the output.

AOUTx defaults to 0 V whenever the device is powered on or a reset command is issued to the device, unless the alarm functionality is enabled for the output.

Alarm Functionality: Either or both outputs may be configured to go to defined values when an Ethernet connection with a host is established or lost.

Slew rate: 5 V/µs

Throughput (software paced): 1000 S/s to 5000 S/s typ, on local network

This is the typical throughput when the device and host are both connected by Ethernet to the same local network. The throughput can vary significantly, and typical throughput is not guaranteed if a wireless connection is involved or data is sent over the internet.

Calibrated Absolute Accuracy (Analog Output)

Range: ±10 V

Absolute accuracy: (± 18.7 LSB)

Calibrated Absolute Accuracy Components (Analog Output)

Range: ±10 V

% of reading: ± 0.024

Offset: ±2.2 mV

Offset Tempco: 30.1 µV/°C

Gain Tempco: 13.2 ppm of range/°C

Relative Accuracy (Analog Output)

Range: ±10 V

Relative accuracy (INL): ±4.0 LSB typ

Analog Input/Output Calibration

Recommended warm-up time: 15 minutes min

Calibration method: Factory

Calibration interval: 1 year (factory calibration)

Digital Input/Output

Digital Type: 5 V TTL input/advanced BiCMOS output

Number of I/O: 8

Configuration: Independently-configured for input or output

Pull-up configuration: All pins pulled up to 5 V using 47 K resistors (default).

Can be changed to pull-down using an internal jumper.

Digital I/O transfer rate (system-paced): 100 to 5000 port reads/writes or single bit reads/writes per second typ, on local network

This is the typical throughput when the device and host are both connected by Ethernet to the same local network. The throughput can vary significantly, and typical throughput is not guaranteed if a wireless connection is involved or data is sent over the internet.

Alarm functionality: Any combination of DIO bits may be configured to become outputs and go to defined values when an Ethernet connection with a host is established or lost.

Power on and reset state: All bits are input unless the alarm functionality is enabled for them.

Input high voltage threshold: 2.0 V min

Input high voltage limit: 5.5 V absolute max

Input low voltage threshold: 0.8 V max

Input low voltage limit: -0.5 V absolute min, 0 V recommended min

Output high voltage: 3.8 V typ at no load, 3.0 V min (IOH = -3 mA),

2.0 V min (IOH = -32 mA)

Output low voltage: 0.15 V typ at no load, 0.55 V max (IOL = 64 mA)

Power on and reset state: Input

External Trigger

Trigger source (external digital): TRIG

Trigger mode: Software-selectable edge or level sensitive; user configurable for

CMOS-compatible rising or falling edge, high or low level

Trigger latency: 2 µs + 1 pacer clock cycle max

Trigger pulse width: 1 µs min

Input type: Schmitt trigger, 47 kΩ pull-down to ground

Schmitt trigger hysteresis: 1.01 V typ, 0.6 V min, 1.5 V max

Input high voltage threshold: 2.43 V typ, 1.9 V min, 3.1 V max

Input high voltage limit: 5.5 V absolute max

Input low voltage threshold: 1.42 V typ, 1.0 V min, 2.0 V max

Input low voltage limit: -0.5 V absolute min, 0 V recommended min

E-1608

Specifications



External Clock Input/Output

Terminal names: AICKI, AICKO

Terminal types

AICKI: Input (receives A/D pacer clock from external source)

AICKO: Output (outputs internal A/D pacer clock)

Input clock rate: 250 kHz max

Clock pulse width

AICKI: 1 μ s min

AICKO: 1.8 μ s min

Clock mode: Edge-sensitive, rising

Input type: Schmitt trigger, 47 k Ω pull-down to ground

Schmitt trigger hysteresis: 1.01 V typ, 0.6 V min, 1.5 V max

Input high voltage threshold: 2.43 V typ, 1.9 V min, 3.1 V max

Input high voltage limit: 5.5 V absolute max

Input low voltage threshold: 1.42 V typ, 1.0 V min, 2.0 V max

Input low voltage limit: -0.5 V absolute min, 0 V recommended min

Output high voltage: 4.4 V min (IOH = -50 μ A), 3.80 V min (IOH = -8 mA)

Output low voltage: 0.1 V max (IOL = 50 μ A), 0.44 V max (IOL = 8 mA)

Counter

Pin Name: CTR

Counter Type: Event counter

Number of channels: 1

Input type: Schmitt trigger, 47 k Ω pull-down to ground

Input source: CTR screw terminal

Resolution: 32 bits

Schmitt trigger hysteresis: 1.01 V typ, 0.6 V min, 1.5 V max

Input high voltage threshold: 2.43 V typ, 1.9 V min, 3.1 V max

Input high voltage limit: 5.5 V absolute max

Input low voltage threshold: 1.42 V typ, 1.0 V min, 2.0 V max

Input low voltage limit: -0.5 V absolute min, 0 V recommended min

Input frequency: 10 MHz max

High pulse width: 50 ns min

Low pulse width: 50 ns min

Memory

Data FIFO (analog input): 49,152 samples

Non-volatile memory: 2,048 bytes (768 bytes for calibration, 256 bytes for user, 1,024 bytes for network settings)

Power

External power supply: 5 V, 1 A

Supply current (quiescent current): 330 mA typ*, 710 mA max including all external loading

User output voltage range (available at +VO terminal): 4.40 V min to 5.25 V max, assumes supplied AC adapter is used

User output current (available at +VO terminal): 10 mA max

Network

Ethernet Connection

Ethernet type: 100 Base-TX, 10 Base-T

Communication rates: 10/100 Mbps, auto-negotiated

Connector: RJ-45, 8 position

Cable length: 100 meters max

Additional parameters: HP Auto-MDIX support

Network Interface

Protocols used: TCP/IP (IPv4 only), UDP

Network ports used: UDP:54211 (discovery), UDP:6234 (bootloader only), TCP:54211 (commands), TCP:54212 (scan data)

Network IP configuration: DHCP + link-local, DHCP, static, link-local

Network name: E-1608-xxxxxx, where xxxxxx are the lower 6 digits of the device MAC address

Network name publication: By NBNS (responds to b-node broadcasts, therefore only available on the local subnet)

* This is the total quiescent current requirement for the device that includes the LEDs. This does not include any potential loading of the digital I/O bits, +VO terminal, or the AOUTx outputs.

Network Factory Default Settings

Factory default IP address: 192.168.0.101

Factory default subnet mask: 255.255.255.0

Factory default gateway: 192.168.0.1

Factory default DHCP setting: DHCP + link-local enabled

Network Security

Security implementation: TCP sockets are not opened unless application sends the correct PIN code (stored in non-volatile memory, may be changed by user, default value 0000)

Number of concurrent sessions: 1

Vulnerabilities: TCP Sequence Number Approximation Vulnerability

LED Displays and the Factory Reset Button

Power LED (top)

3.3 V < V_{ext} < 5.9 V: On

V_{ext} < 3.3 V, V_{ext} > 5.9 V: Off (power fault)

Activity LED (bottom): On when there is a valid host connection and blinks when a command is received or an AInScan is running.

Ethernet connector LEDs

Left, green: Link/activity indicator; on when there is a valid Ethernet link and blinks when network activity is detected.

Right, yellow: Speed indicator; on for 100 Mbps, off for 10 Mbps or no link.

Factory reset button: Used to reset the network configuration settings to the factory default values.

Environmental

Operating temperature range: 0 °C to 55 °C max

Storage temperature range: -40 °C to 85 °C max

Humidity: 0% to 90% non-condensing max

Mechanical

Dimensions (L x W x H)

Standard version: 117.9 x 82.8 x 29.0 mm (4.64 x 3.26 x 1.14 in.)

OEM version: 98.30 x 76.71 x 14.61 mm (3.87 x 3.02 x 0.575 in.)

Screw Terminal Connectors (E-1608 Standard)

Connector type: Screw terminal

Wire gauge range: 16 AWG to 30 AWG

Header Connectors (E-1608-OEM)

I/O connector type: Two 2 x 8 pin 0.1 in. pitch headers labeled W2 and W4

Power connector type: DC barrel input jack labeled 4 (mates with 5.5 mm OD / 2.1 mm ID plug) and 1 x 2 pin 0.1 in. pitch header labeled W1

E-1608

Ordering



Order Information

Hardware

Part No.	Description
E-1608	Ethernet-based DAQ device with eight analog inputs, 250 kS/s sample rate, two analog outputs, one 32-bit counter input, and eight DIO lines. Includes network cable, power adapter, and MCC DAQ software.
E-1608-OEM	Board-only Ethernet-based DAQ device with eight analog inputs, 250 kS/s sample rate, two analog outputs, one 32-bit counter input, and eight DIO lines.

Accessories and Cables

Part No.	Description
PS-5V1AEPS	5 volt, 1 amp power supply. Shipped with the E-1608 standard device; optional component with the E-1608-OEM. Interchangeable plugs are available separately.
ACC-205	DIN-rail kit; compatible with the E-1608 standard device.

Software also Available from MCC

DAQami	Easy-to-use advanced data logging application to acquire, view, and log data
TracerDAQ Pro	Out-of-the-box virtual instrument suite with strip chart, oscilloscope, function generator, and rate generator – professional version
DASYLab	Icon-based data acquisition, graphics, control, and analysis software