

Y-axis limit switch and mounting hardware.

NOTE:
See limit switch hole templates for the Y- and Z-axes on page 4.

SHERLINE PRODUCTS
INCORPORATED 1974

Mill Limit Switch Mounting Retrofit Instructions

Retrofitting your CNC Leadscrew Mill with Limit Switches

To mount the eccentric trigger on the column saddle and the Y-axis limit-switch mount on the mill base, you will need to drill and tap some holes on your machine. Below you will see print copies. One is for the 8-32 hole location that you must drill and tap in your column saddle for the eccentric trigger (see Figures 1, 2, and 3). The other is for the 5-40 holes in the mill base (see Figures 4 and 5).

Z-Axis Limit Switch

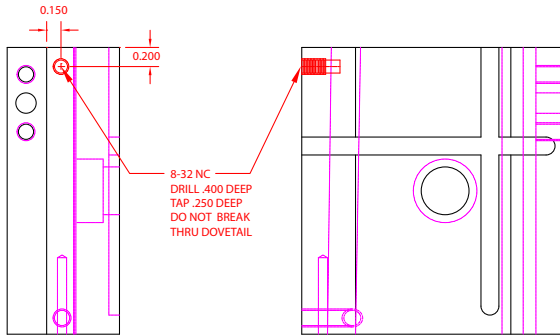

FIGURE 1—CNC leadscrew column saddle 8-32 hole location diagram for the eccentric trigger.

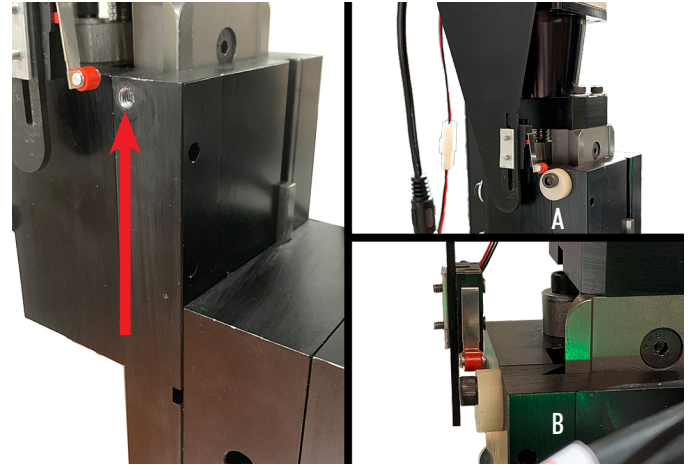

FIGURE 3—The red arrow indicates the eccentric trigger hole location on the ball screw column saddle. Figures A and B show the eccentric trigger mounted in place.

Y-Axis Limit Switch

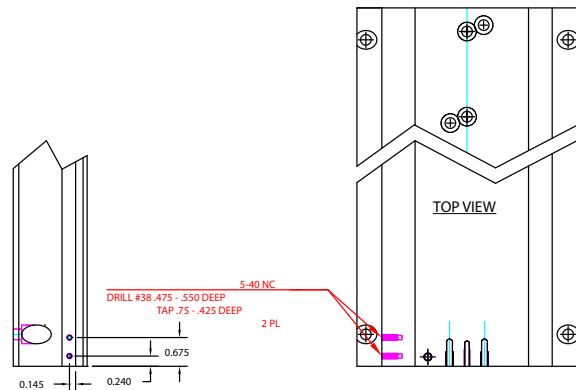

FIGURE 4—CNC leadscrew mill base 5-40 hole location diagram

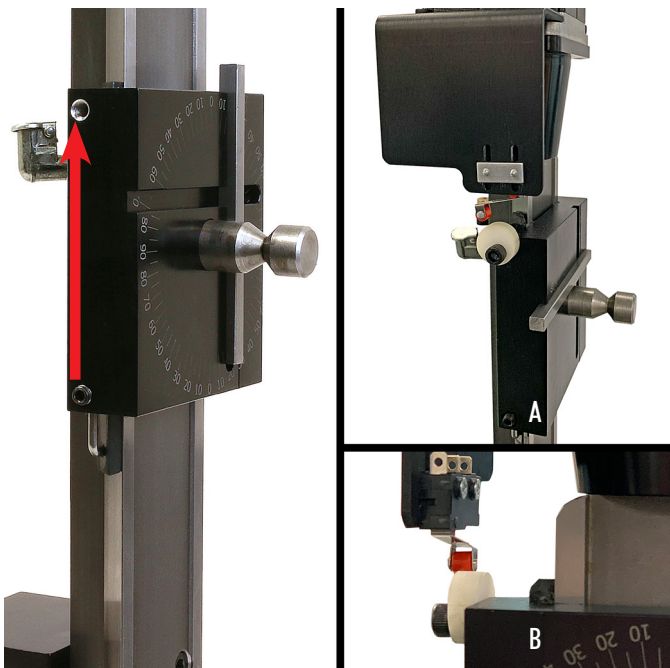

FIGURE 2—The red arrow indicates the eccentric trigger hole location on the standard leadscrew column saddle. Figures A and B show the eccentric trigger mounted in place.

Metric Screw Equivalents

For those who live outside of the USA and don't have access to 8-32 and 5-40 taps, the metric equivalent to these screws is listed below.

The metric thread equivalent and screw lengths for the inch screws are as follows:

- P/N 12051: 4 x 0.7 mm x 10 mm long = 8-32 x 3/8" SHCS
- P/N 67114: 3 x 0.5 mm x 22 mm long = 5-40 x 7/8" SHCS

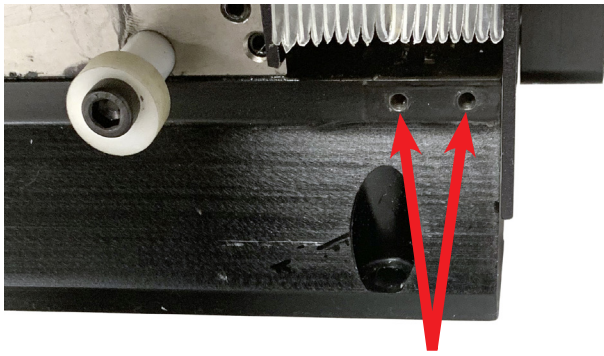

FIGURE 5—The red arrows indicate the 5-40 screw hole locations for the mill base, limit-switch mount.

The limit switch and other components will clear the accordion mounting bolt and the cover.

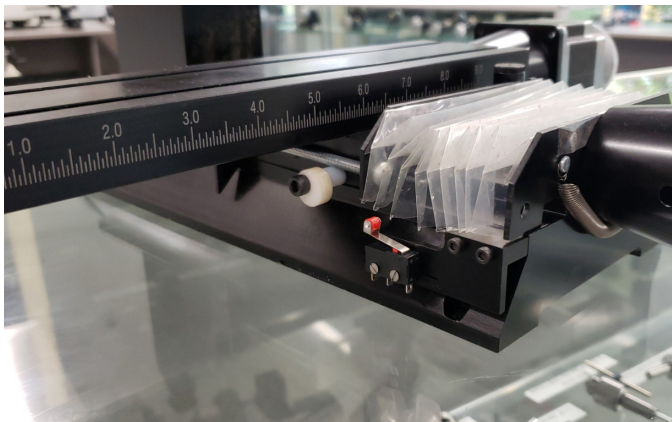

FIGURE 6—The Y-axis limit switch assembly for leadscrew machines with the accordion cover.

Limit Switch and Eccentric Assembly

The relationship between the limit switch ball and the center of the eccentric is critical, especially on the Y-axis. The eccentric should force the ball on the limit switch arm downward. If the limit switch and the eccentric are aligned so the ball is slightly above centerline of the eccentric, the eccentric will force the ball and arm of the limit switch upward. This will break the limit switch arm and run the axis into the hard stop.

1. When you install the Y-axis limit switch, adjust the eccentric so it looks like the picture in Figure 7.

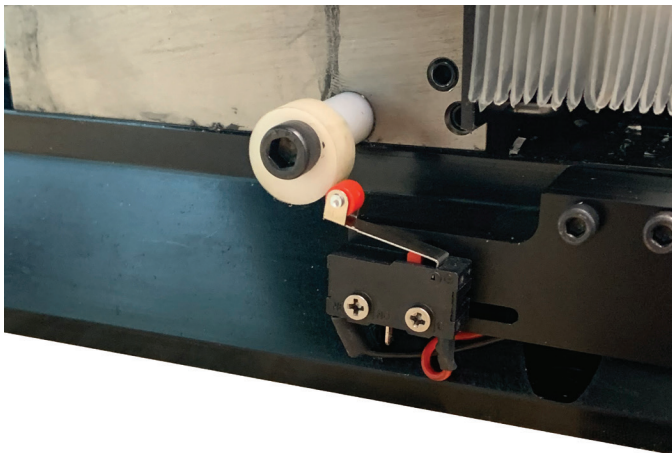

FIGURE 7

2. Figure 8 shows how the ball rolls to the bottom side of the eccentric as the Y-axis moves toward the stepper motor.

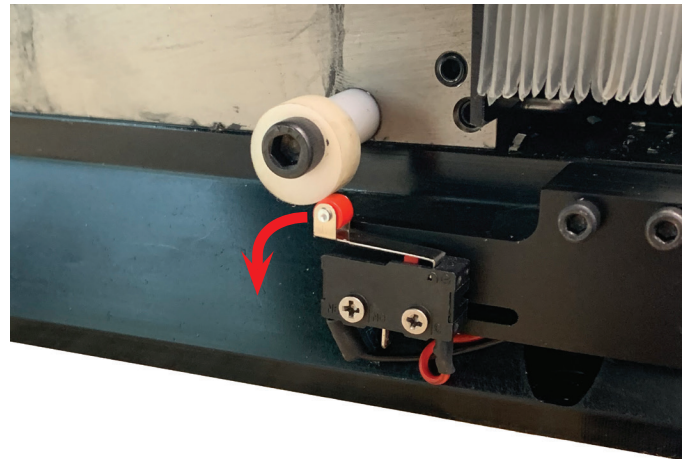

FIGURE 8—The red arrow shows how the limit switch should roll under the eccentric.

3. You may need to bend the limit switch arm down a bit to get the proper engagement and limit switch direction.

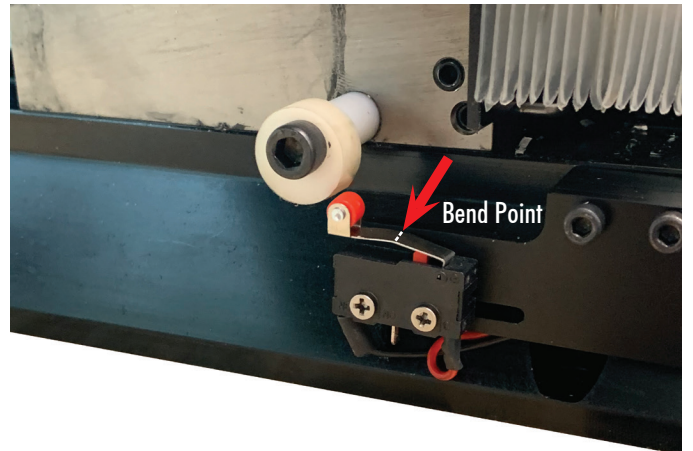

FIGURE 9—The red arrow shows where you might need to bend the limit switch arm to get it to roll under the eccentric.

4. You don't want the eccentric to make contact with the ball and force it upward.

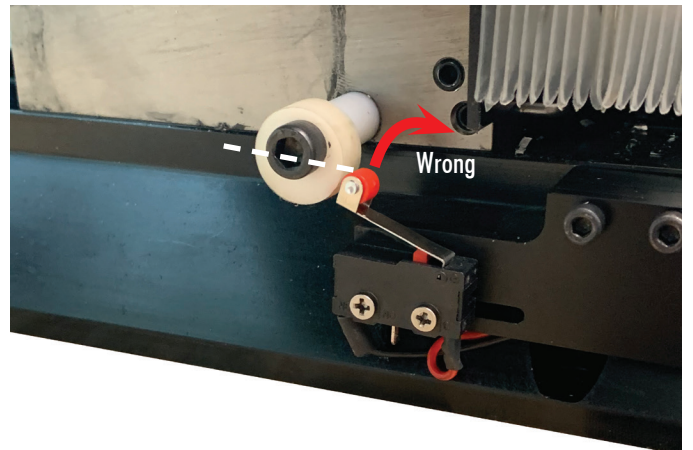

FIGURE 10—The limit switch is now above the centerline of the eccentric, and is in danger of being forced upward.

X-Axis Limit Switch

In order for the limit switch to clear the Y-axis accordion cover mounting bolt, you will need to drill and tap an 8-32 hole in the mill saddle for an 8-32 x 3/8" SHC screw, P/N 12050. This 8-32 screw becomes the trigger stop for the limit switch so the limit switch will not hit the accordion cover mounting bolt (see Figures 11-14).

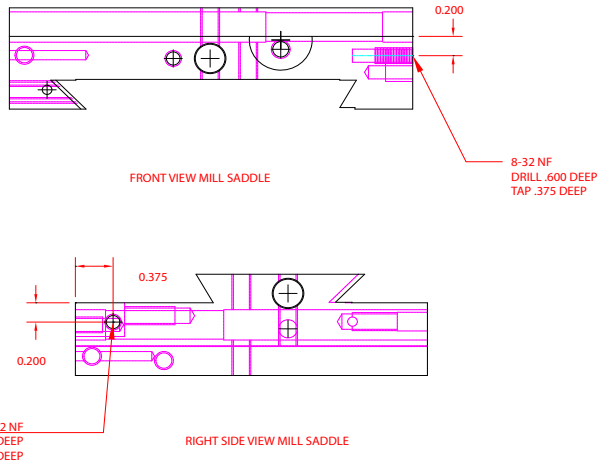

FIGURE 11—Print for 8-32 hole location

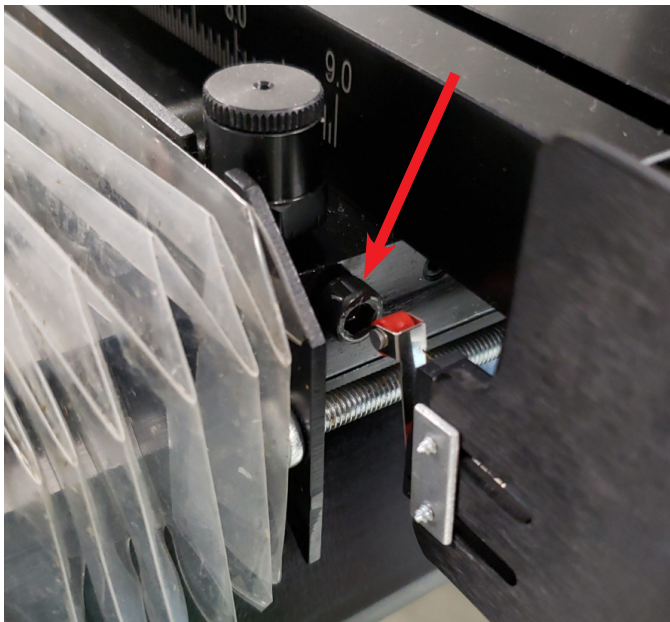

FIGURE 12—8-32 screw assembled

There shouldn't be any interference with the accordion cover bolt. If there is, bend the roller ball arm on the limit switch out and away from the limit switch body just enough to trigger the limit switch prior to any contact with the bolt.

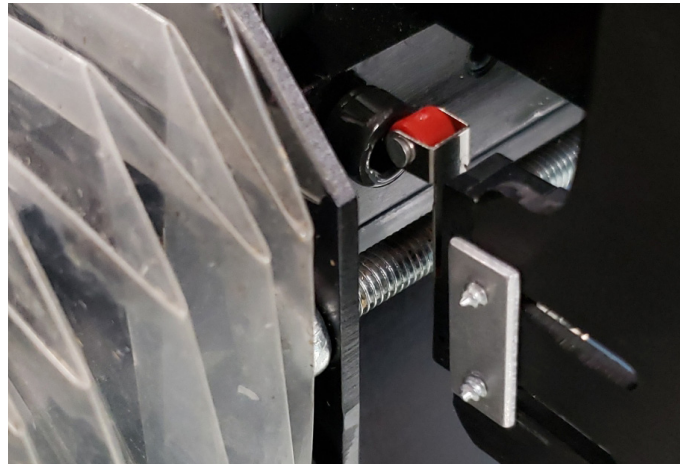

FIGURE 13—Shows the X-axis limit switch in the closed position.

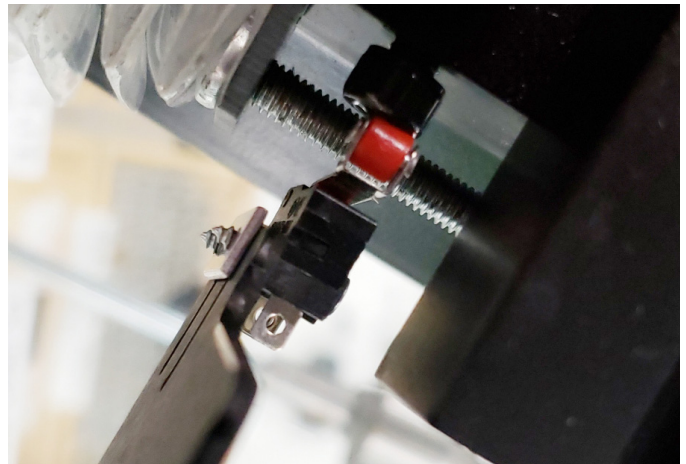
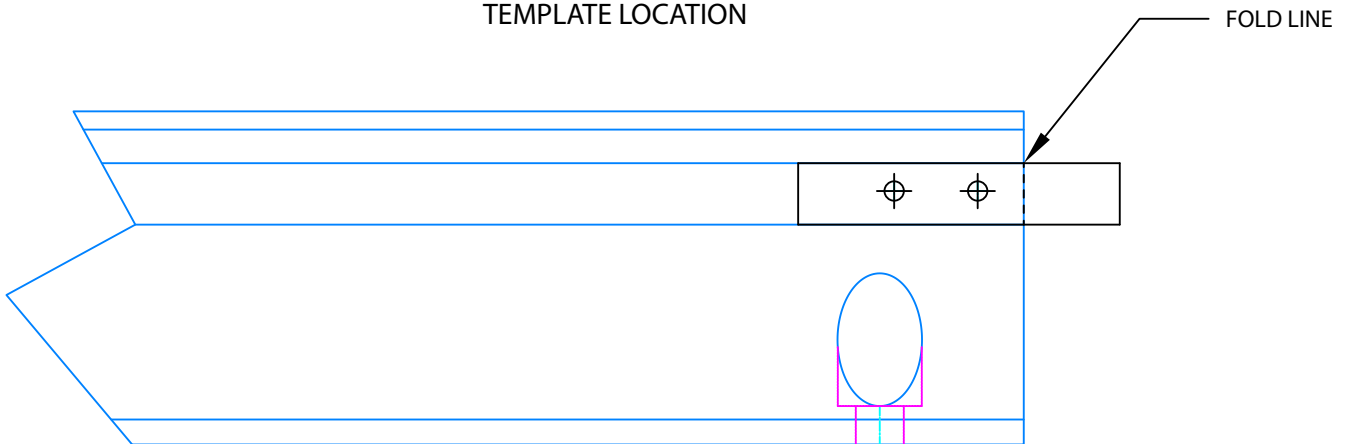

FIGURE 14—Top view of the X-axis limit switch and the stop screw.

Limit Switch Mounting Templates

MILL BASE LIMIT SWITCH HOLES TEMPLATE LOCATION



Mill Base Template Instructions

Cut the template out on the solid lines. Fold the template on the dashed line and tape it in place on your mill base. Position the targets on the side of the mill and the extra fold at the front of the base. The targets indicate the hole locations for the Y-axis limit switch mounting 5-40 screws. You will need to remove the accordion way cover plate before affixing the template if you have one mounted on your mill.

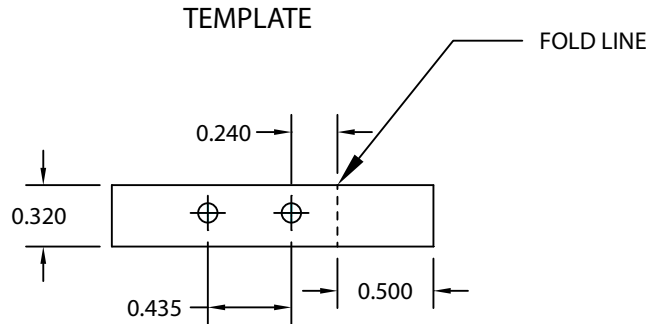

COLUMN SADDLE ECCENTRIC TRIGGER HOLE TEMPLATE LOCATION

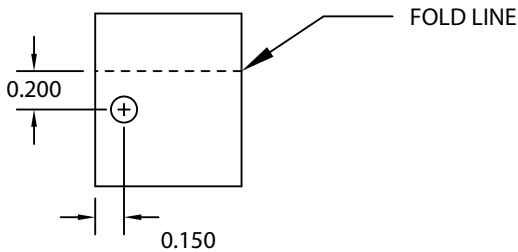

TEMPLATE

Column Saddle Template Instructions

Cut the template out on the solid lines. Fold the template on the dashed line and tape it in place on the top of your column saddle as seen in the diagram to the right. Position the target on the side of the saddle and the extra fold on top of the saddle. The target indicates the hole location for the Z-axis eccentric trigger mounting 8-32 screw.

