

LIFTY CRANE

Make a robot that lifts or lowers an object when you press the A or B buttons on the micro:bit.

Tools & Materials

Included in kit:

- Lifty Crane Templates
If you need to print new templates, you can download them here:
<https://www.okdo.com/p/okdo-microbit-build-a-paper-robot-kit/>
- Continuous Rotation Micro Servo (EF90D, micro:servo 360°)
- 3x Crocodile to Male Jumper Pin Cables
- micro:bit v2 Board
- Micro USB Cable

Not included in kit:

- Computer
- Scissors or Craft Knife
- Glue
- Tape
- String (dental floss works great)

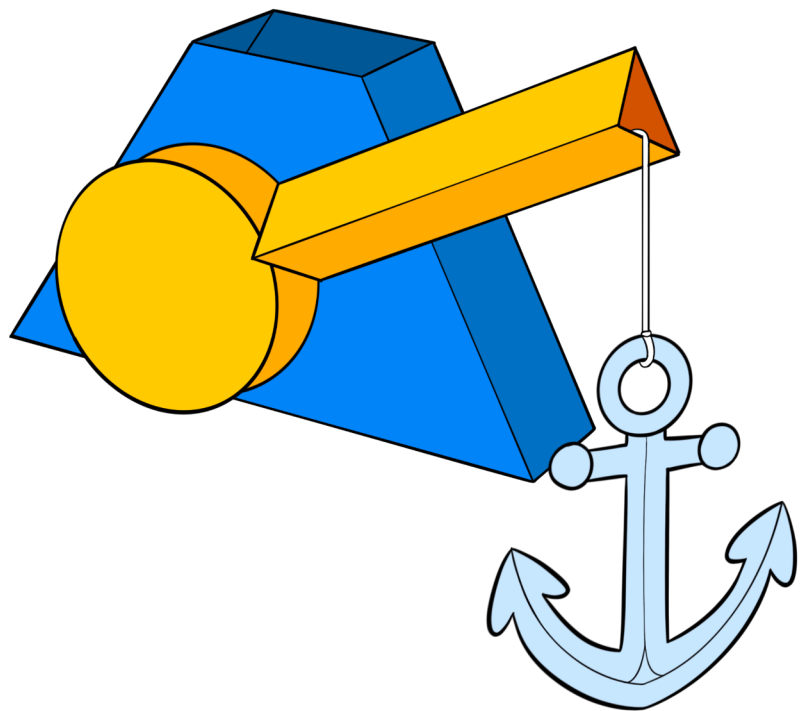

Lifty Crane templates and instructions © Jasmine Florentine 2022

This work is licensed under a Creative Commons Attribution-NonCommercial-ShareAlike 4.0 International License: <https://creativecommons.org/licenses/by-nc-sa/4.0/>

The included templates and instructions are made available under a CC BY-NC-SA-4.0 license. This means you are free to copy, print, translate, and remix elements of the templates as long as it is not for commercial purposes. We only require that you attribute Jasmine Florentine and OKDo and that any derivative works (such as translations and lesson plans) also use the same CC BY-NC-SA-4.0 license.



1

Start by cutting all the pieces out of first page of the template. You might find it easiest to use a craft knife for the cutouts (the part shaded in grey). Make sure to have an adult help if you use a craft knife.

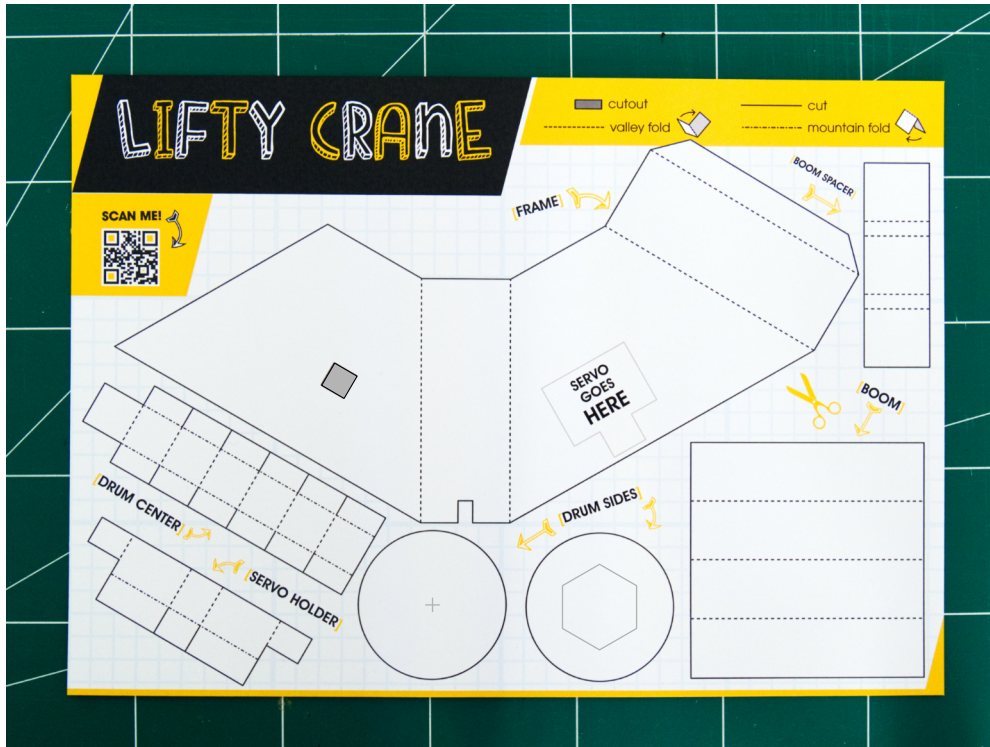

You can use a hole punch for this cutout if it's difficult to cut.

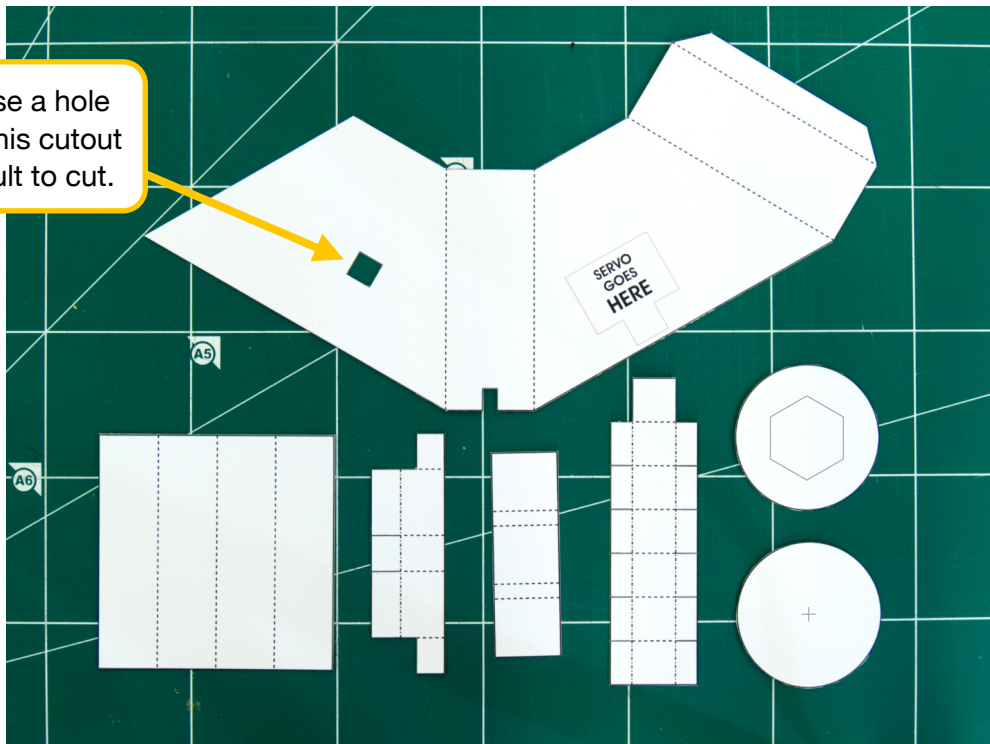

2

Pre-crease all the fold lines. This will make assembly easier later on.

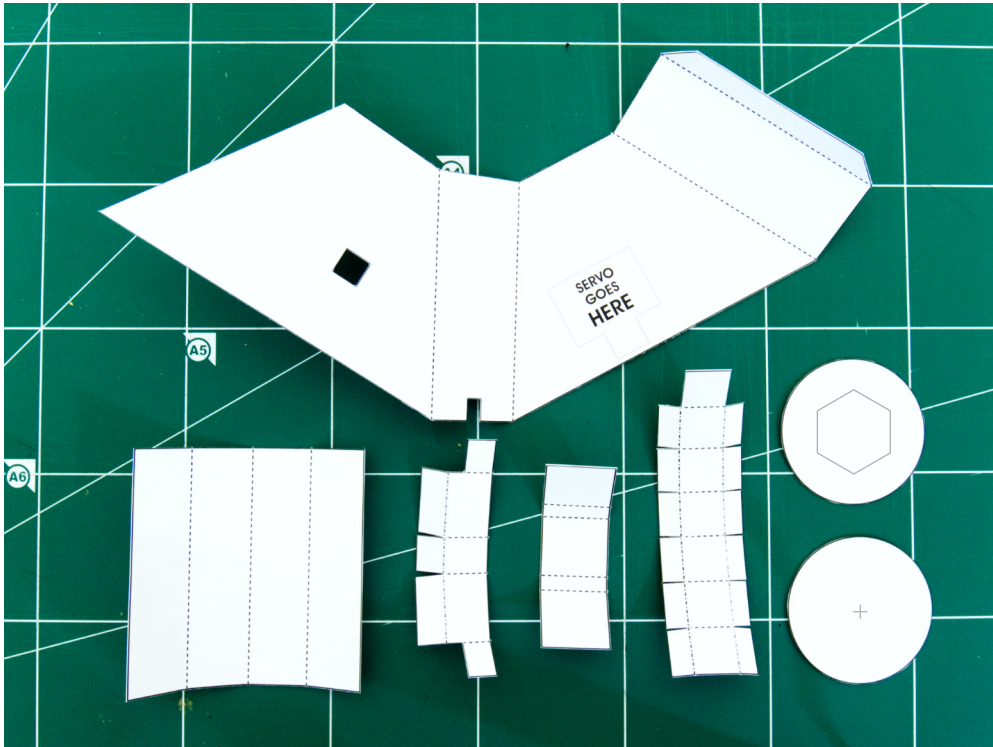

3

You can decorate the Lifty Crane when it's finished, but you might find it easier to color some of the parts while it's still disassembled. (I colored the parts on the backside, since all the fold lines will be hidden on the inside).

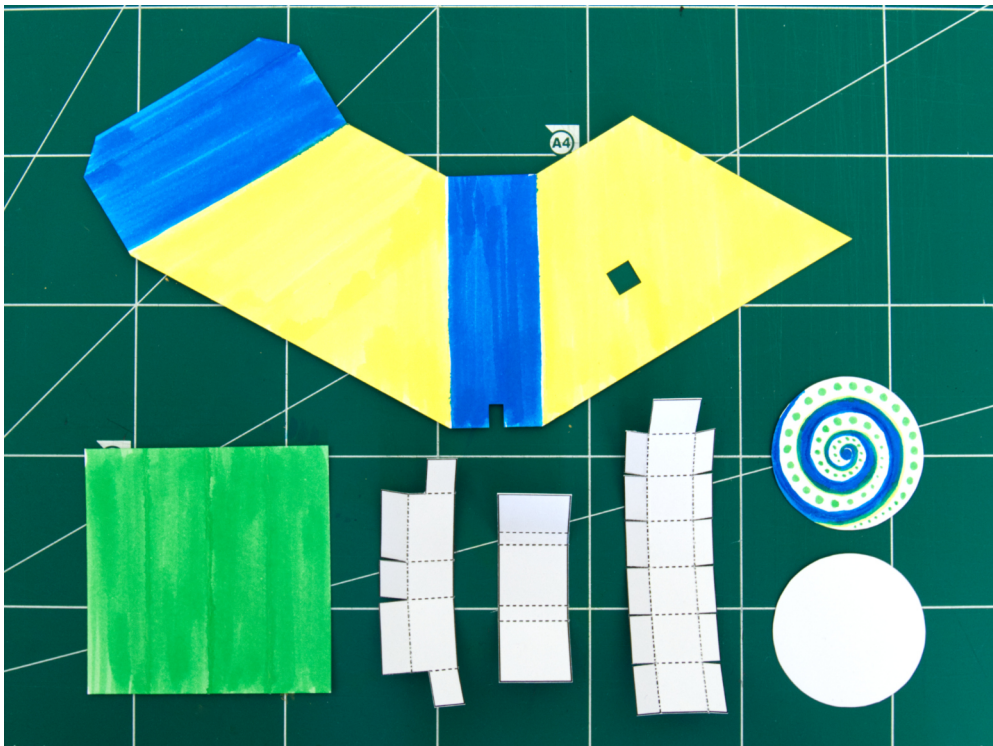

4

Glue or tape the servo holder around the servo. You don't need to put glue on the servo itself, just on the paper tabs that wrap around the servo body.

Note: For this project, make sure you're using the **continuous rotation 360° servo** (the one labeled EF90D).

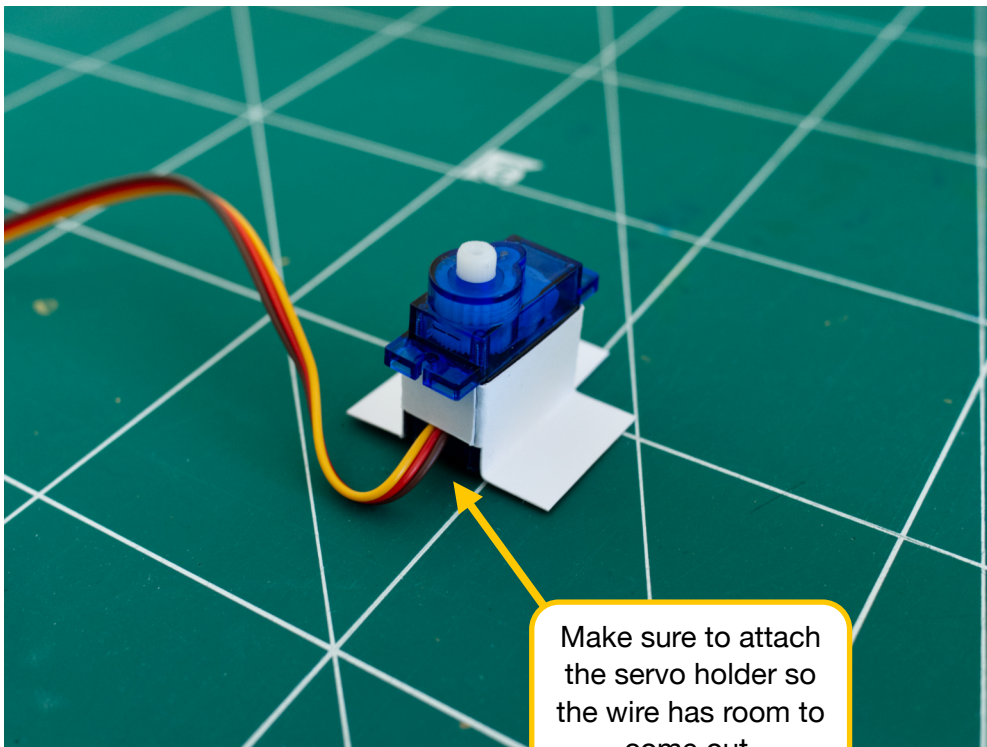
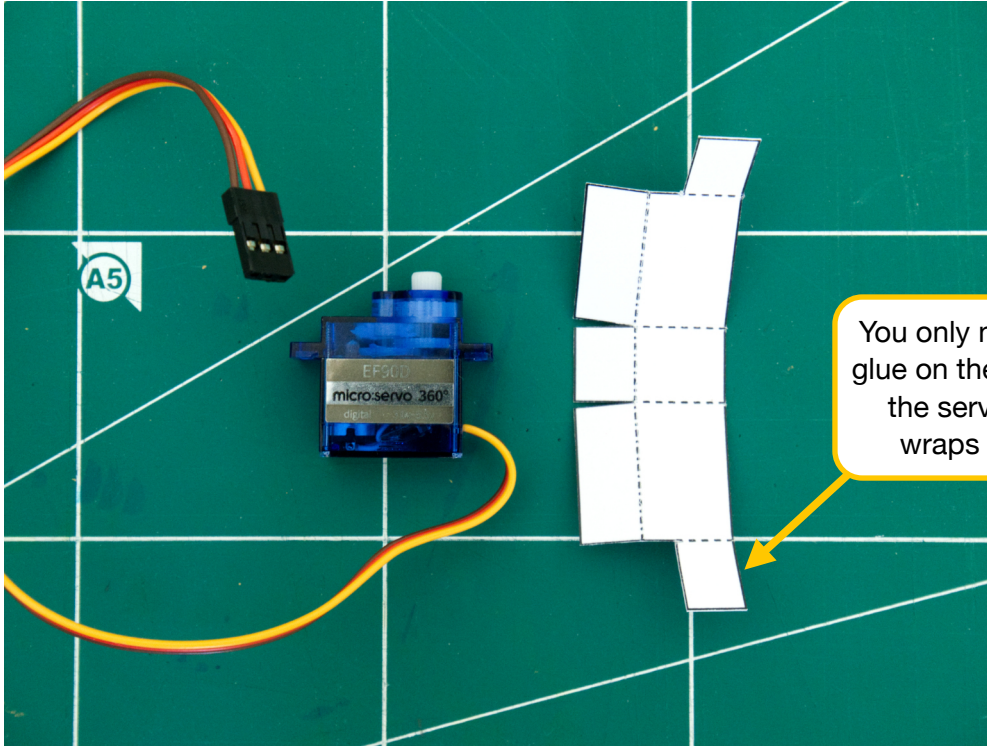

5

Glue or tape the servo in place where shown. Once again, you don't need to put glue on the actual servo — you can just put it on the paper tabs of the servo holder.

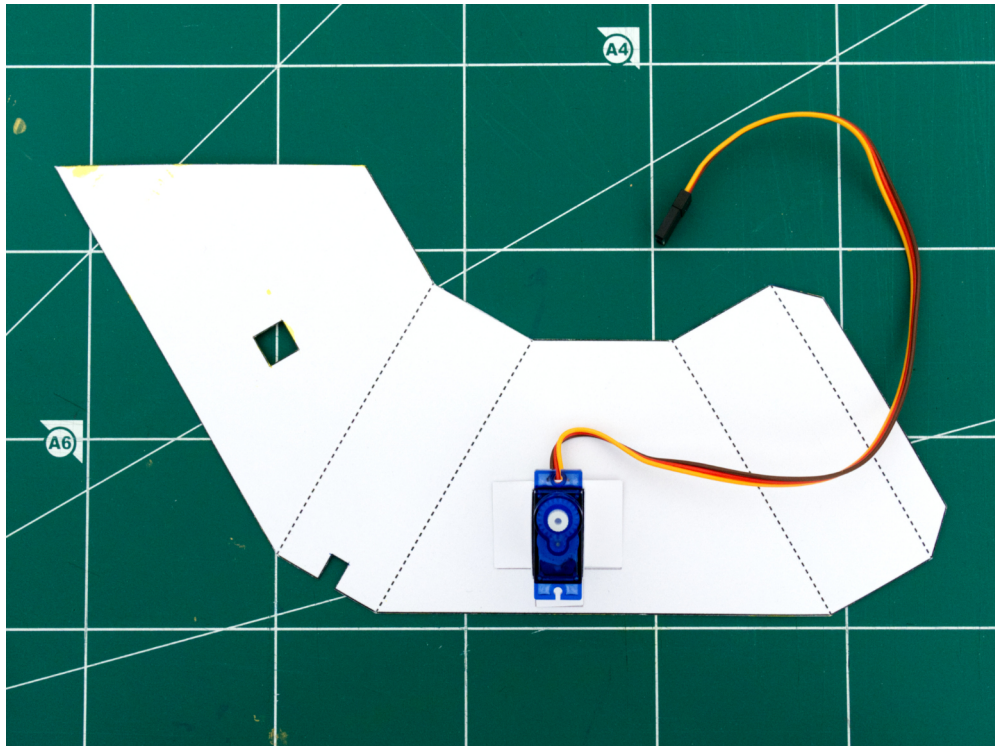
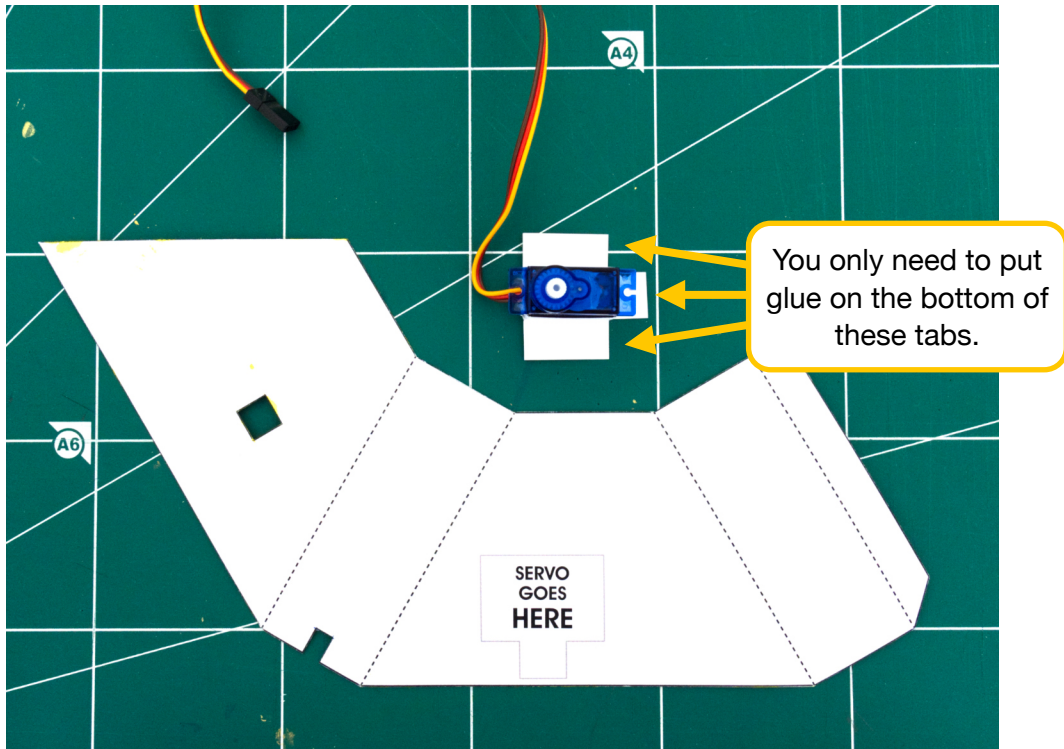

6

Fold the frame and use the tab to glue or tape it together. The cutout should be positioned just above the servo axle.

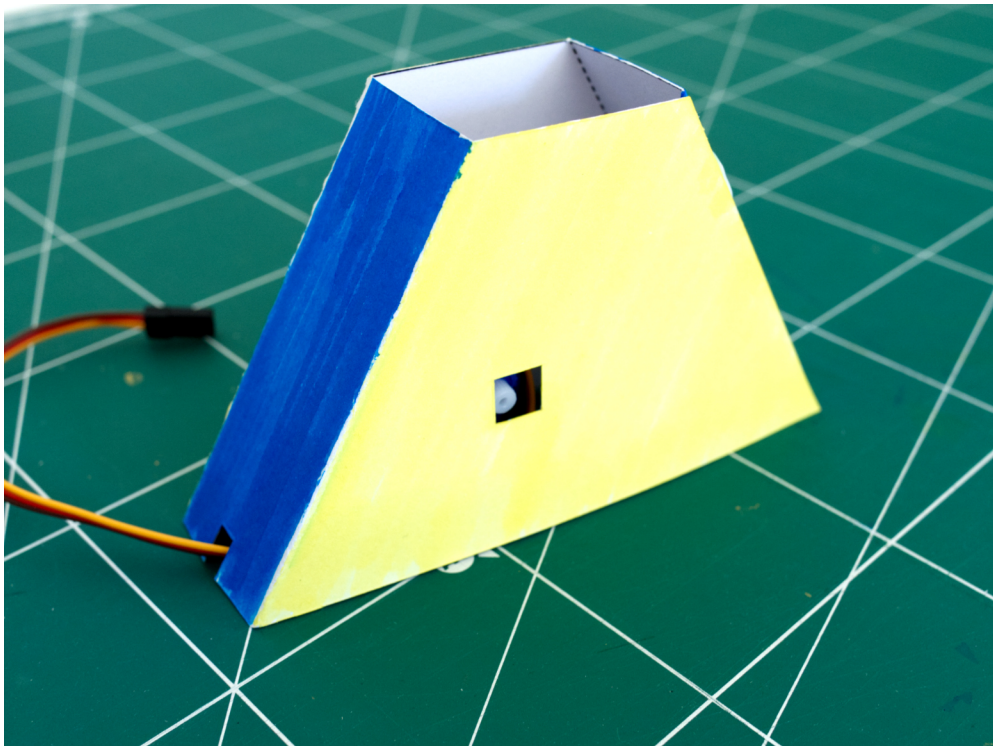
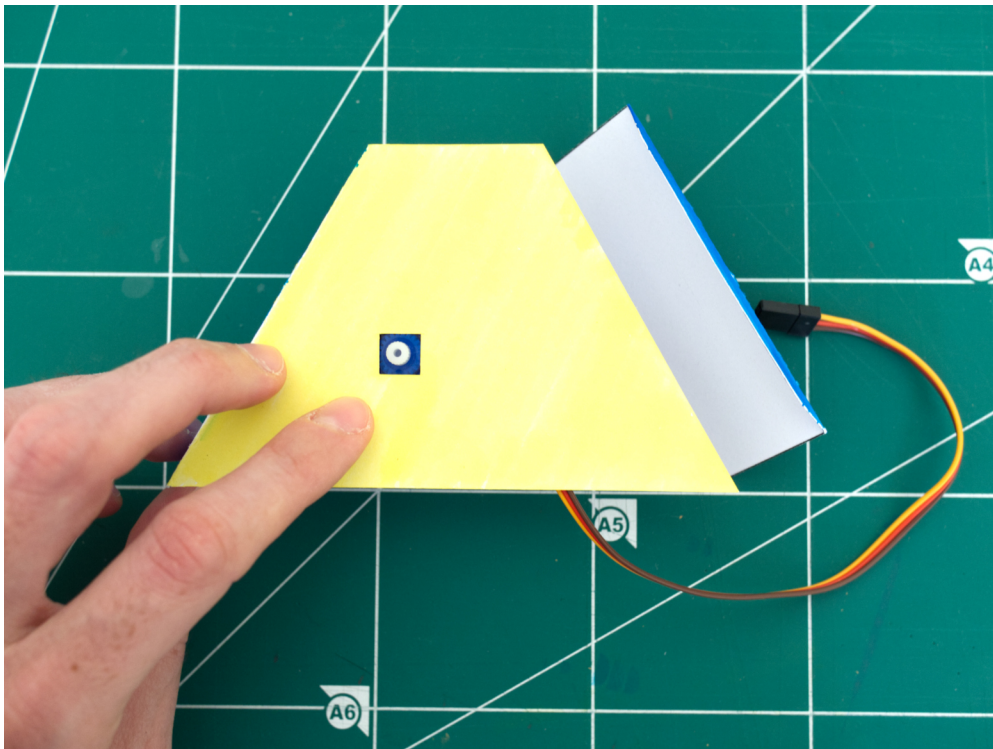

7 Next, we'll assemble the drum (the part that spins).

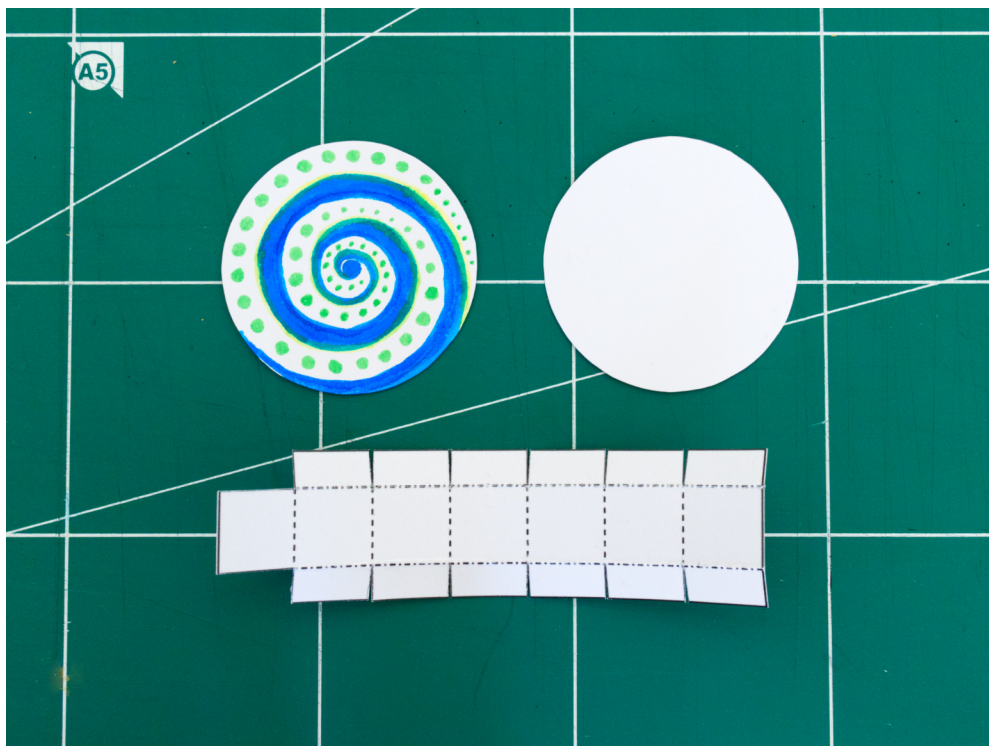

8 Fold and glue (or tape) the drum center so it forms a hexagon shape.

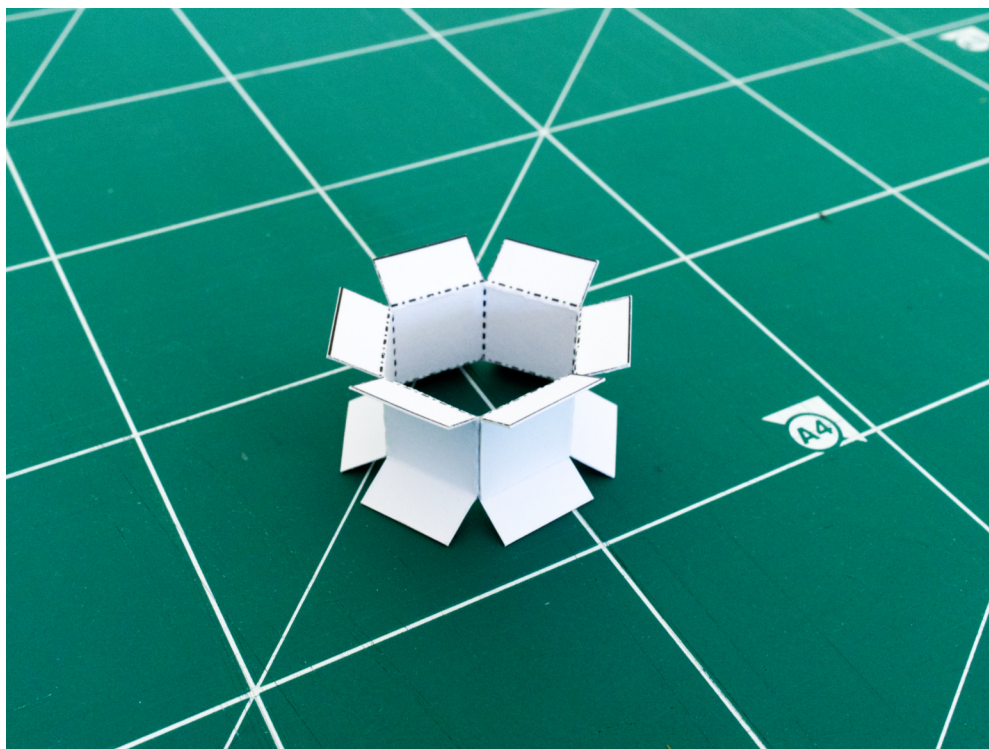

9

Glue or tape the drum center to the drum side with the hexagonal marking, using the marking to help position it.

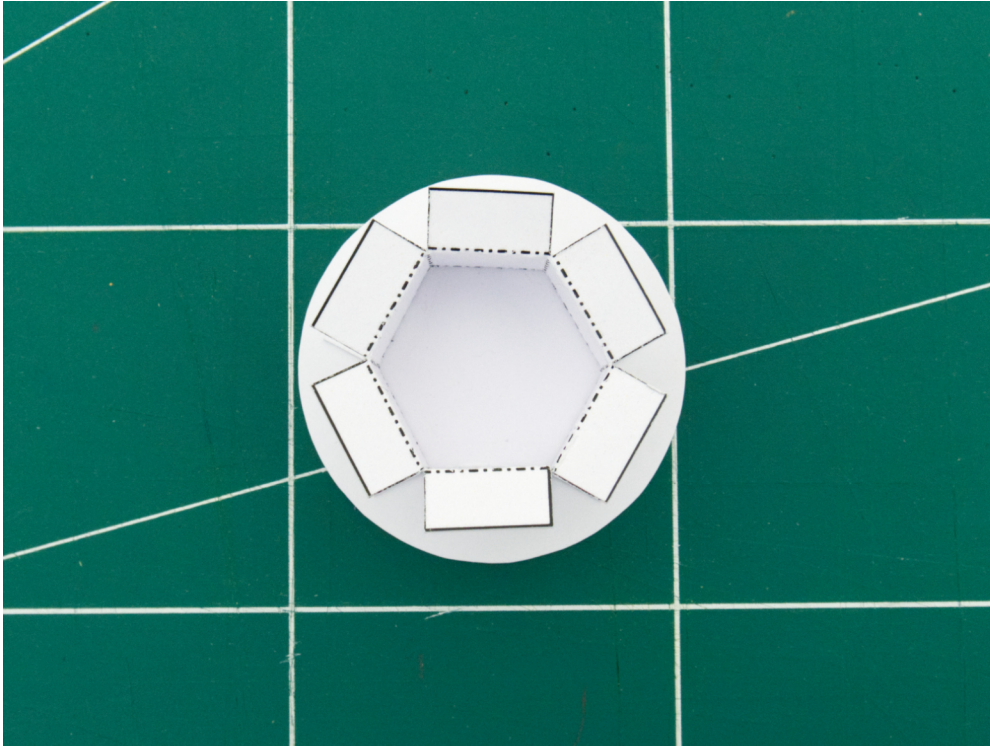

10

Glue or tape the other drum side to the drum center to form the full drum. Make sure the side with the + center mark is facing outwards.



11

Use the center mark on the drum side to position and tape one of the servo horns to it. It doesn't matter which servo horn you use, but the cross shape it easy to tape because of the long arms.

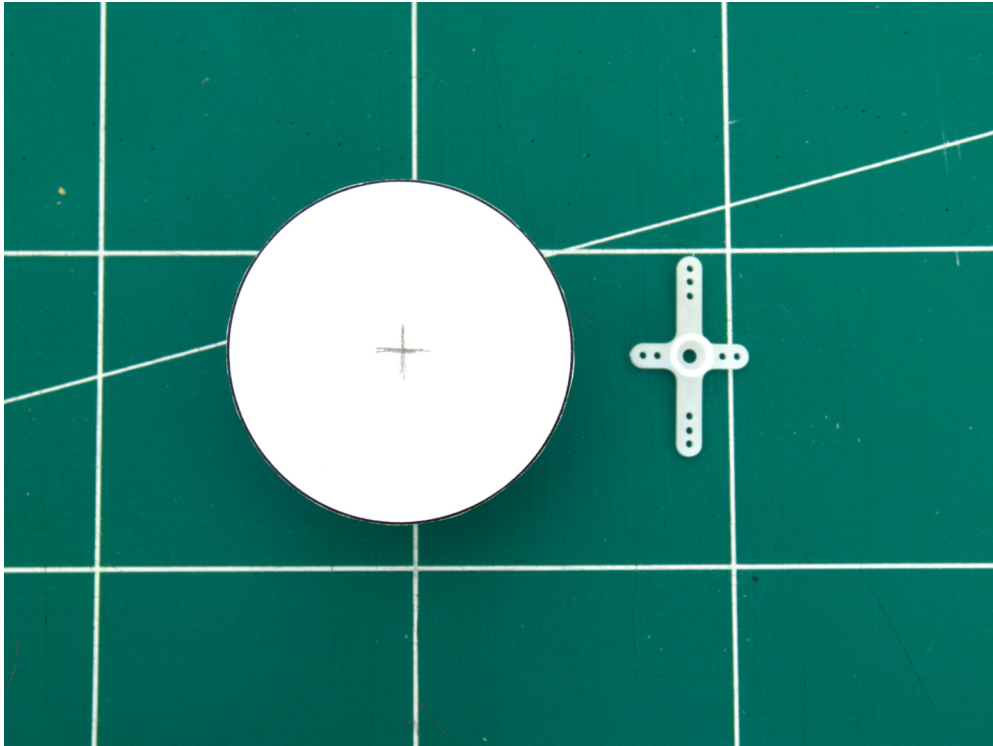

12

Attach the drum to the servo by pressing the servo horn onto the servo axle (you may need to push the servo from inside the frame).

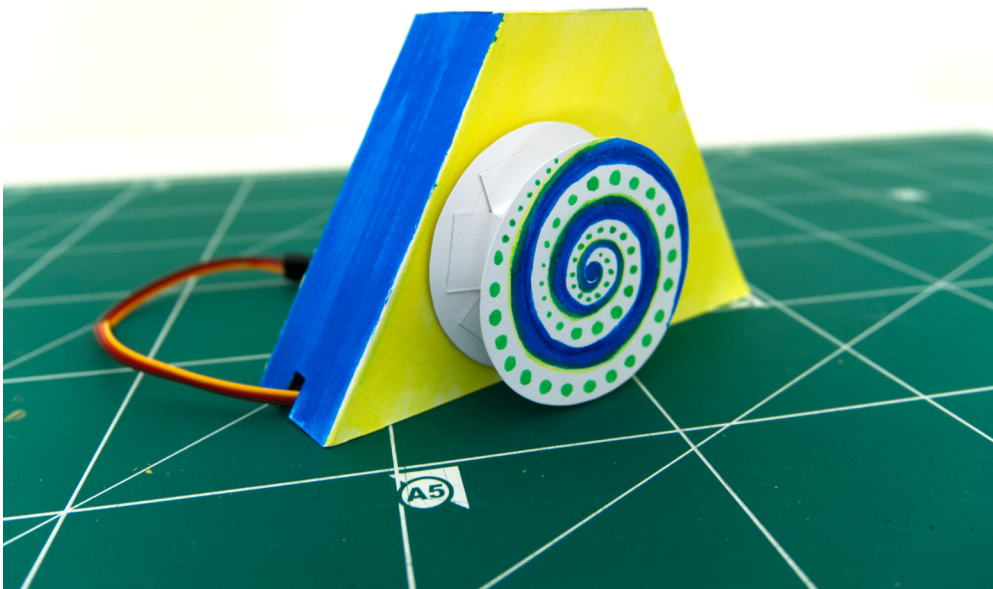
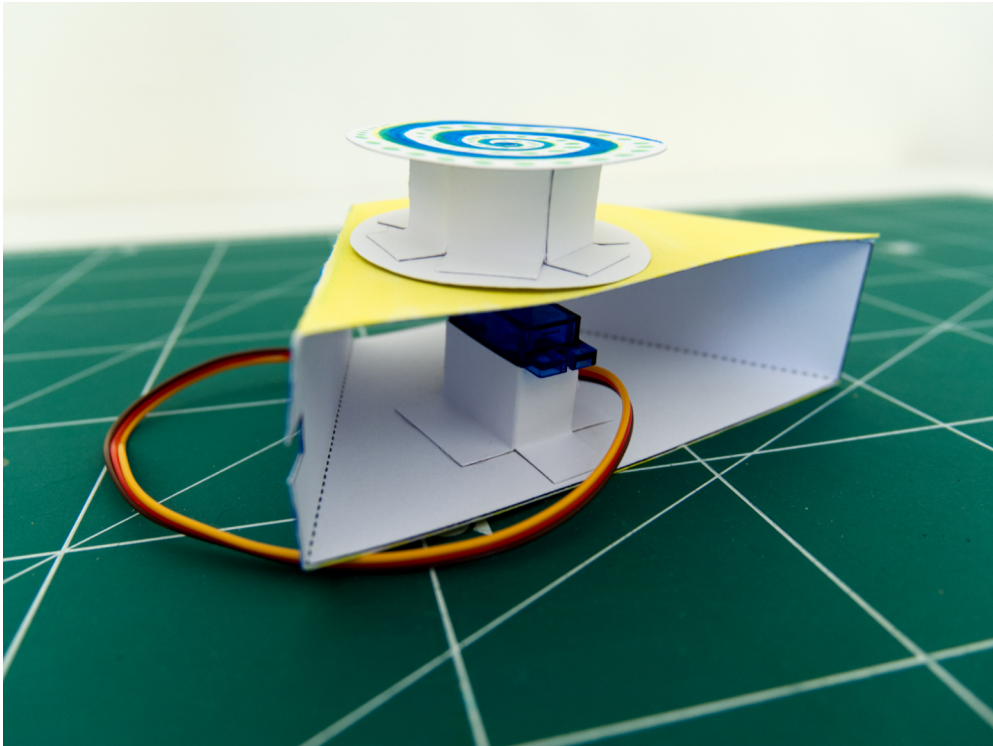

13

Let's move onto the boom and the boom spacer. Fold and glue (or tape) them into shape.

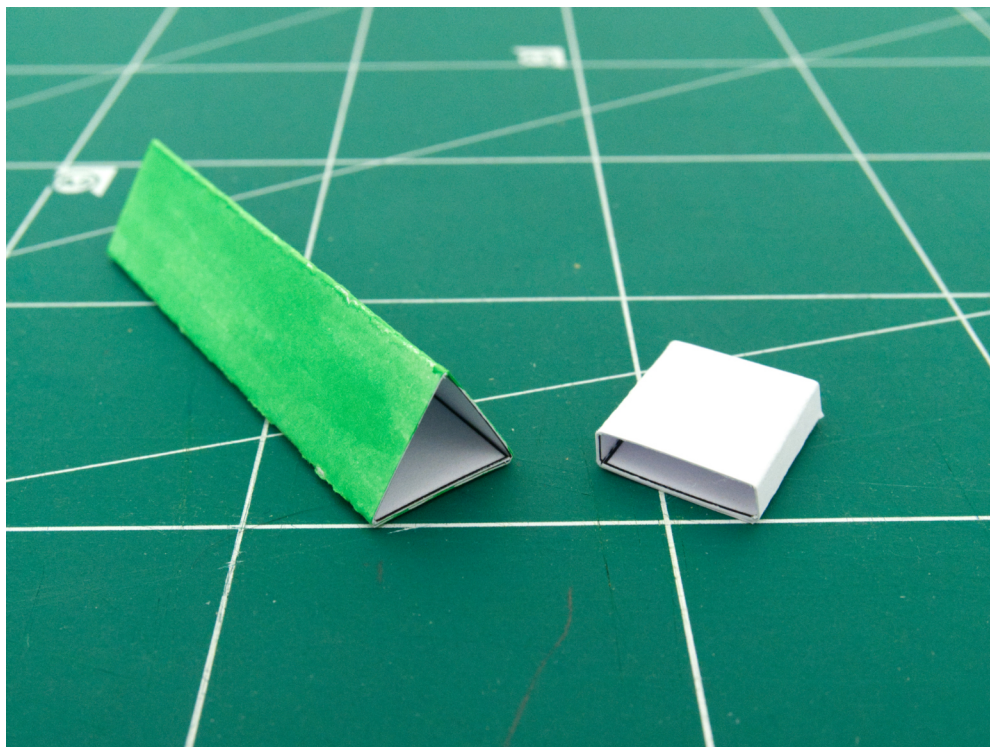
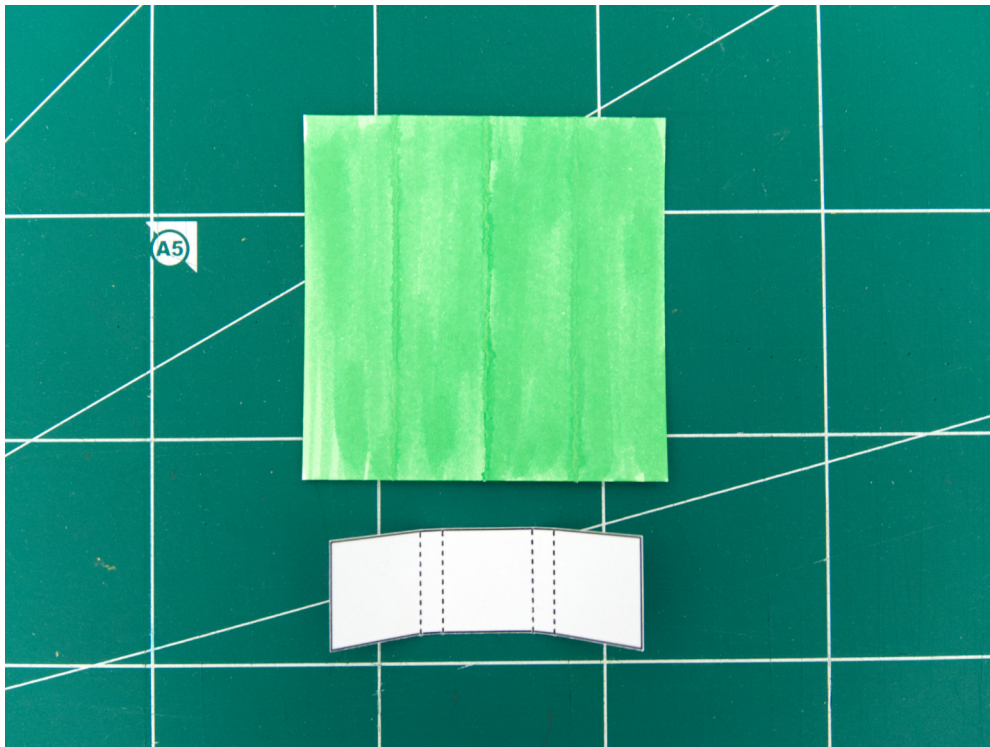

14

Glue or tape the boom spacer to the end of the boom.

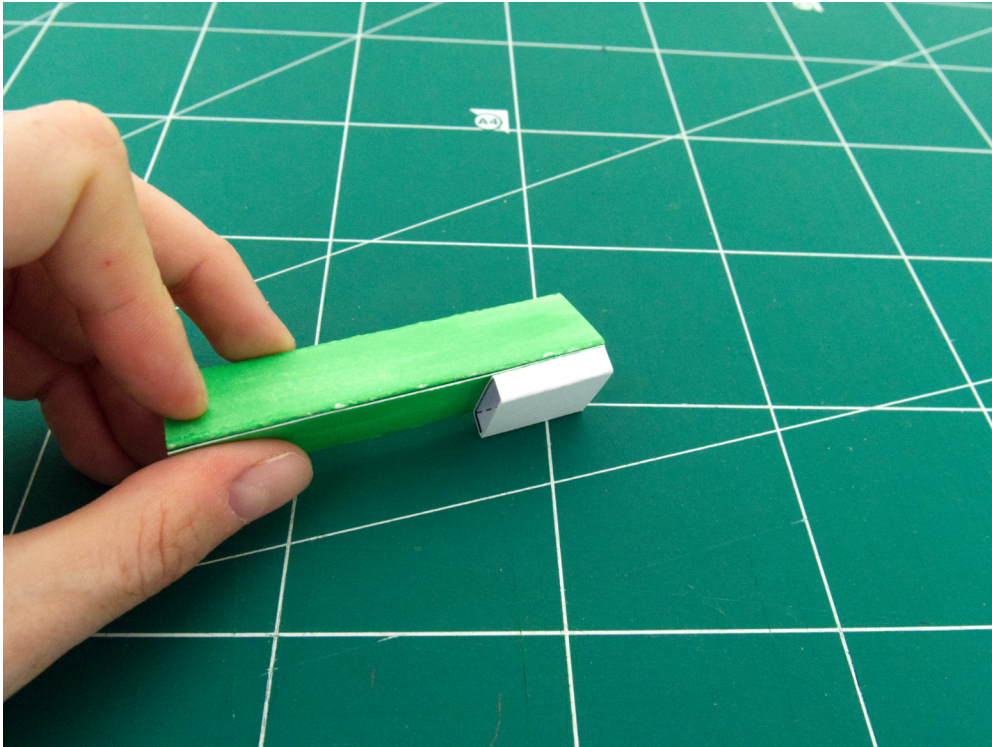

15

Glue or tape the boom with the boom spacer to the frame so it's more or less centered with the drum (see the red dotted line in the second picture).

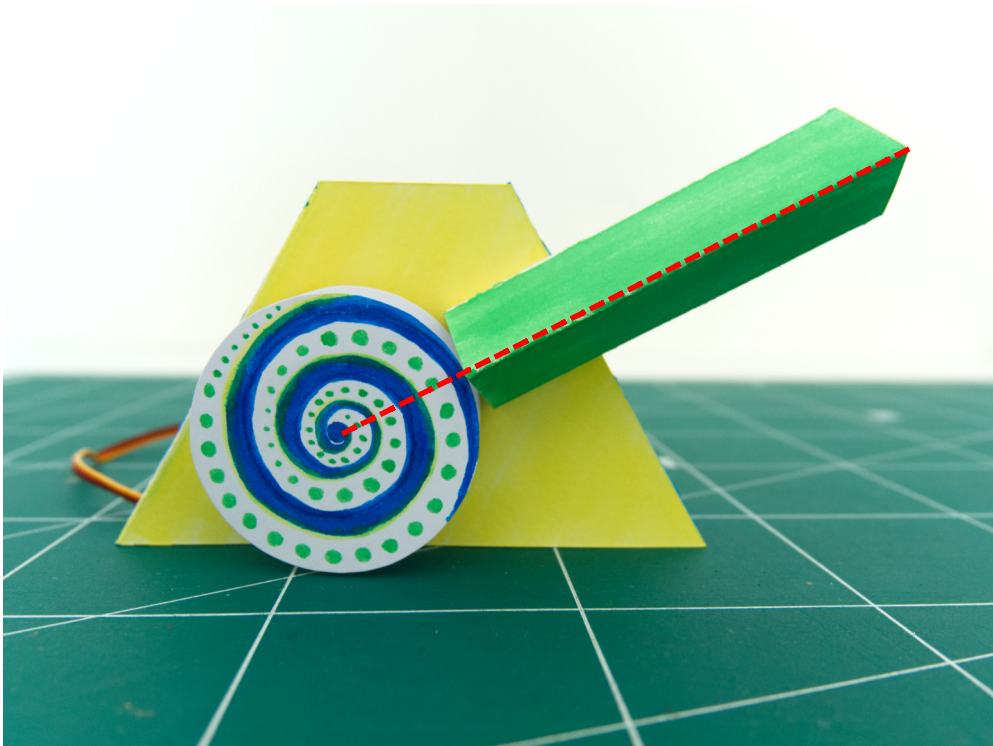
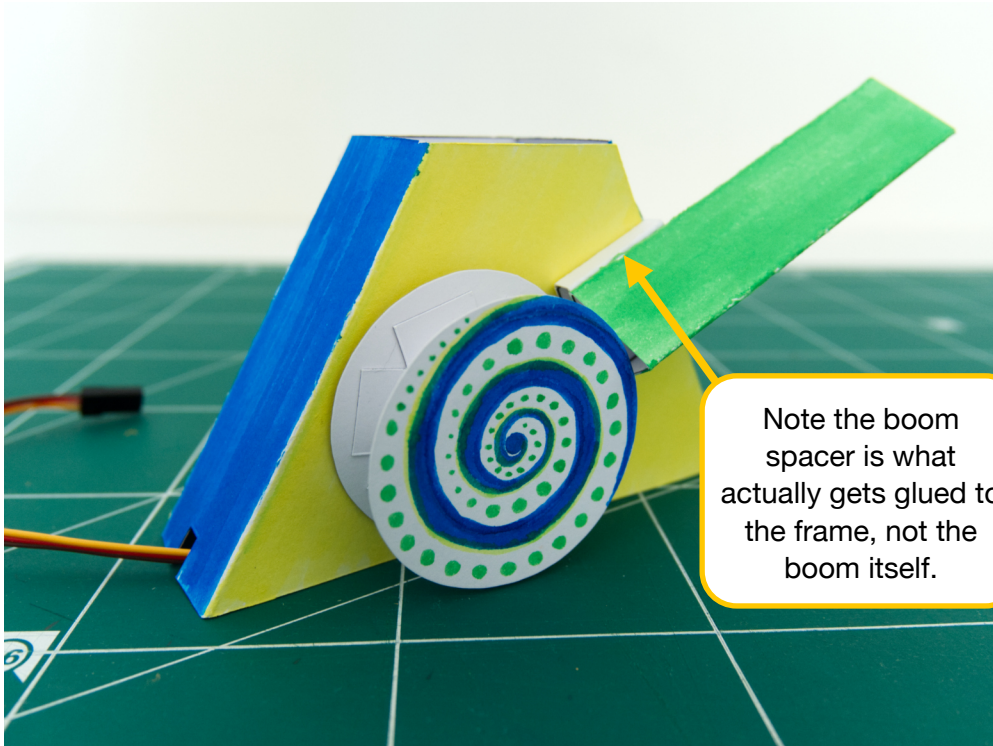

16

Cut a piece of string (I used dental floss) around 50-70 cm long and pull it through the boom. If you have trouble getting it through, you can tie a paperclip to one end and use it to guide the string.

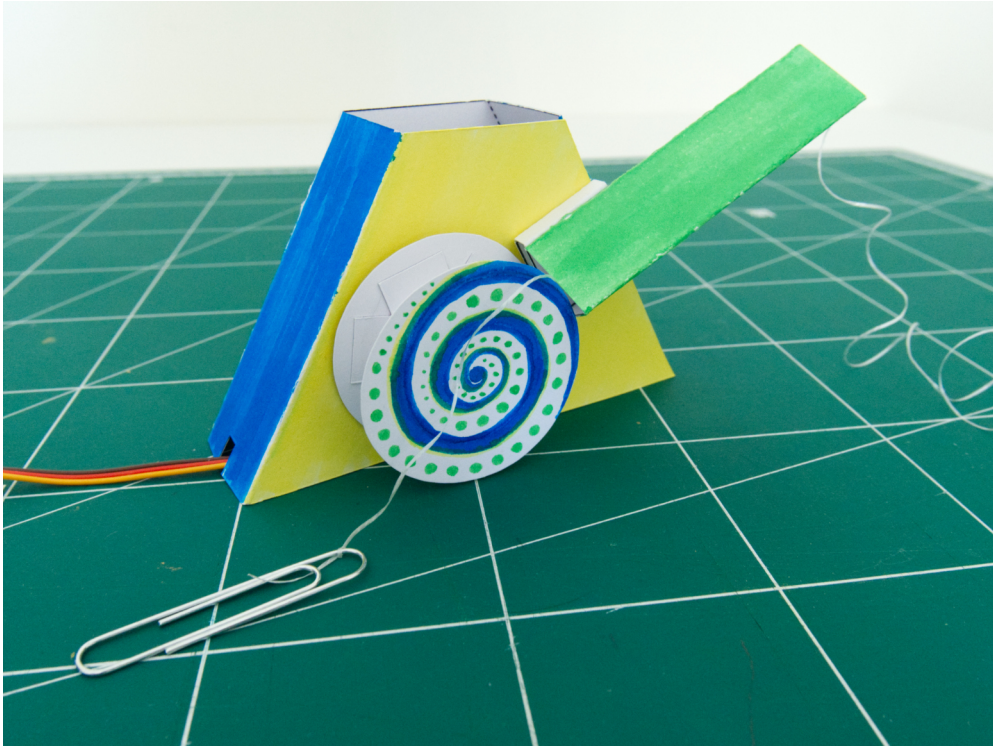

17

Remove the paperclip and tape the end of the string to the drum side.

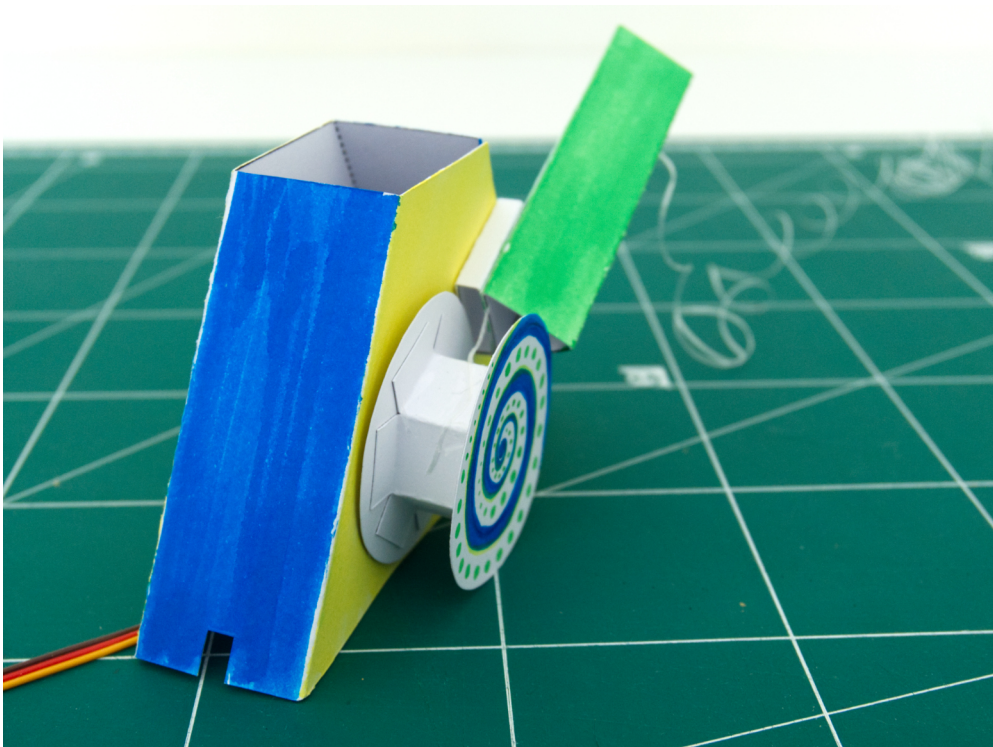

It's time to make something for the Lifty Crane to actually lift! You can use whatever you want so long as it's not too heavy—paper clips, pom-poms, or any of the pictures from the template. I used the fish.

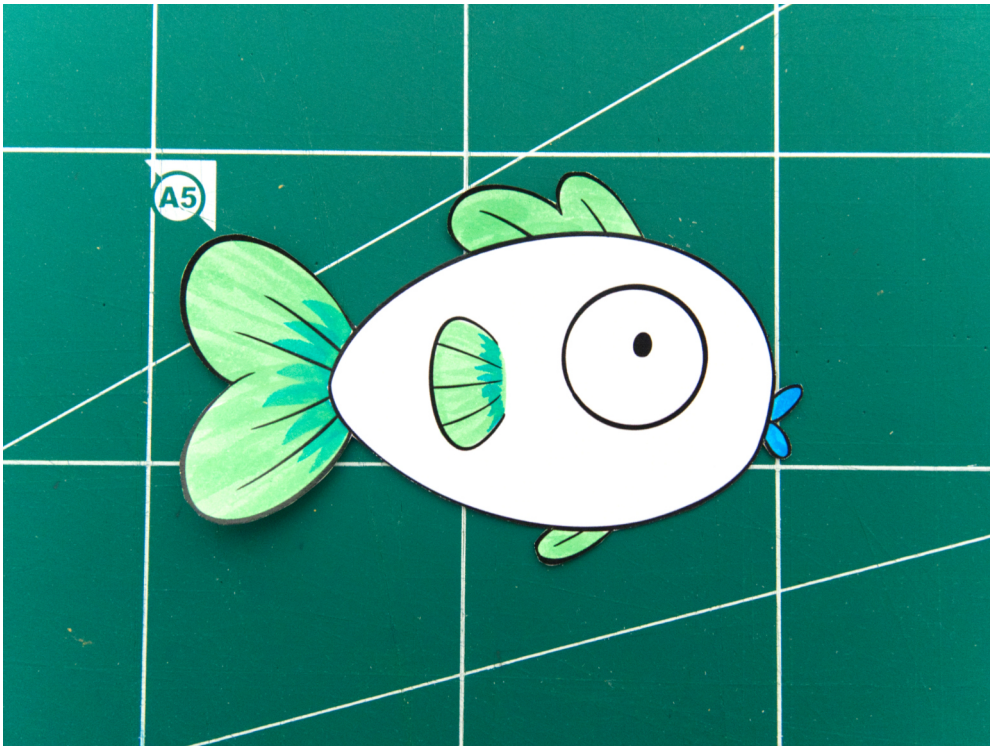

19

Tape or tie whatever you're lifting to the other end of the string.

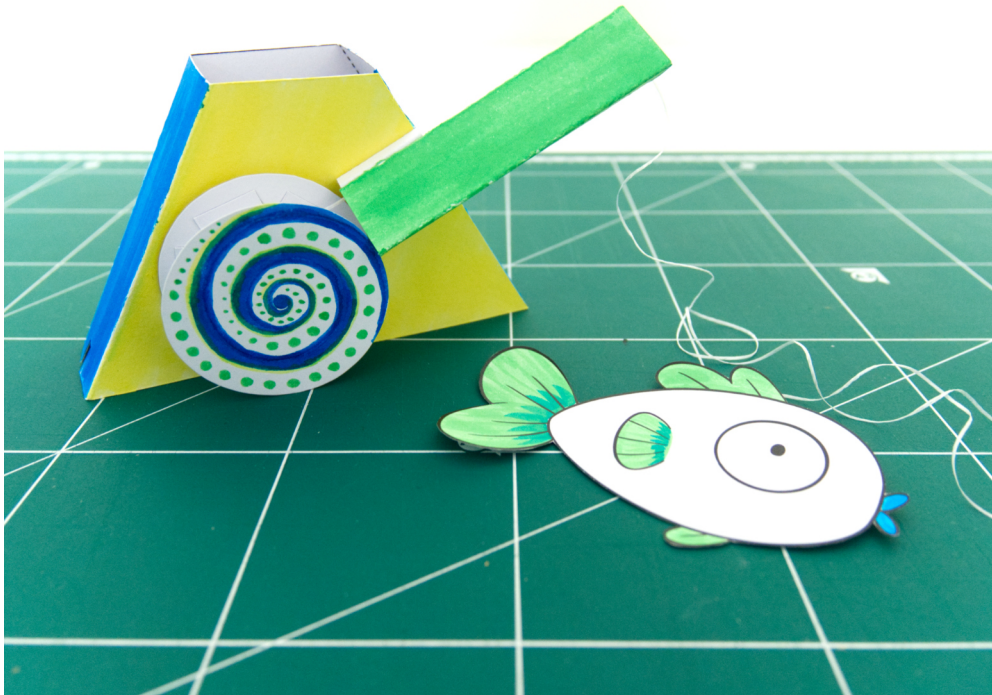

20

Almost done! Now it's time to connect the electronics and program the Lifty Crane. Connect 3 of the the crocodile to male jumper pin cables to the servo header. You can use any color of crocodile cables, but if you match the color of the servo wires to the crocodile cables, it will make it much easier to keep track of the connections.

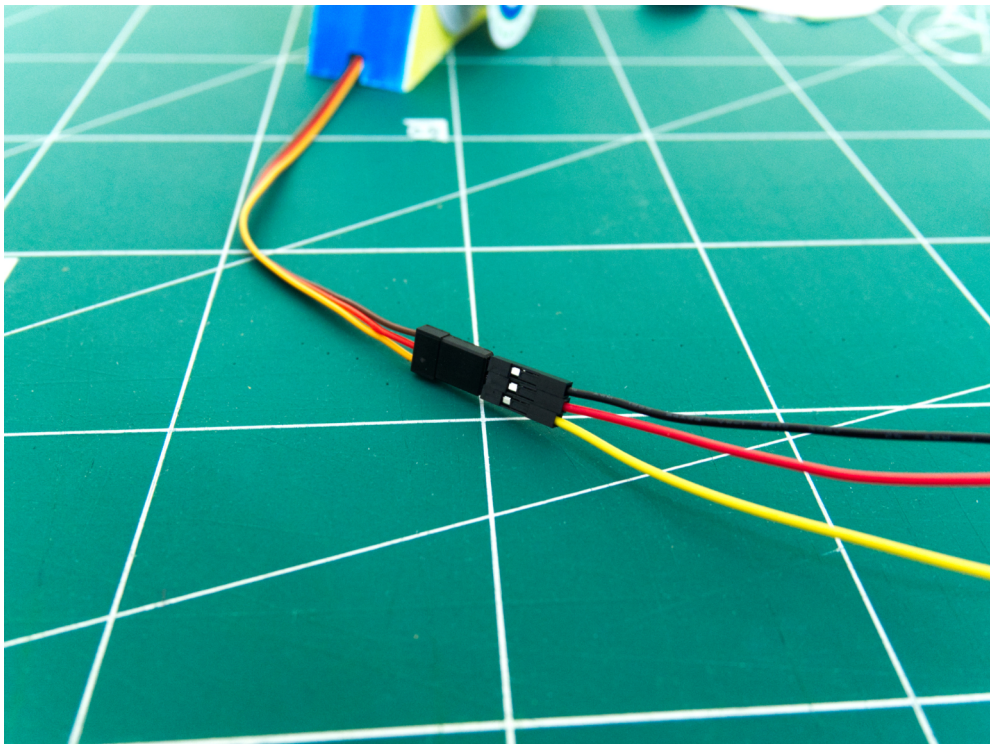
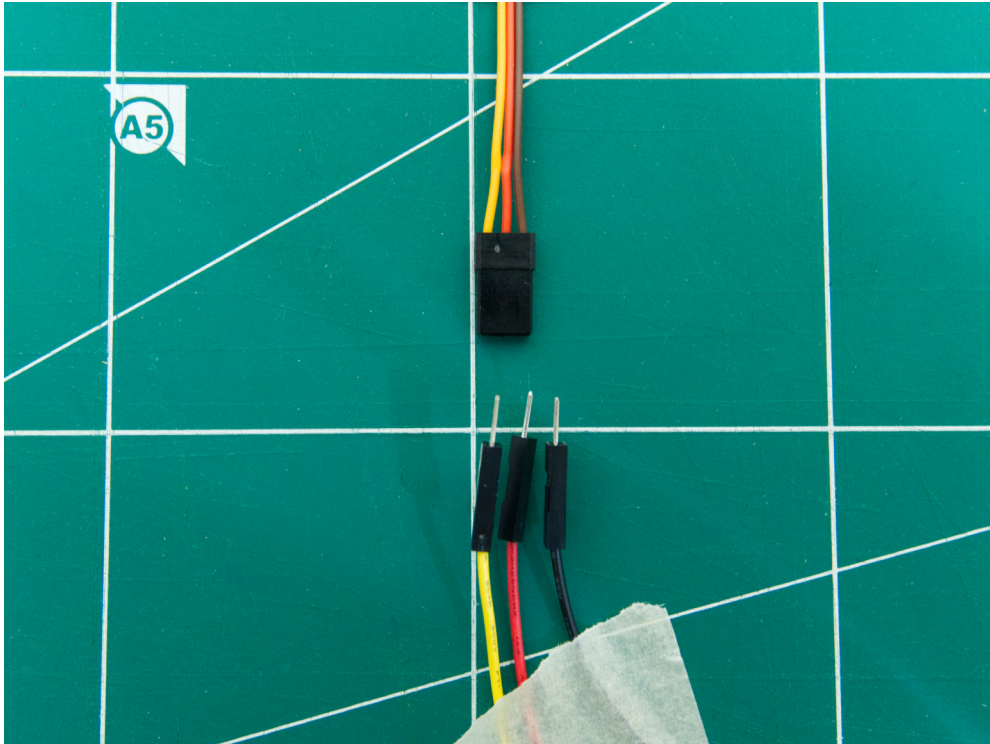

21

Connect the crocodile clips to the micro:bit. Make sure that they are connected as follows:

- Crocodile clip connected to the YELLOW servo wire → micro:bit Pin 0
- Crocodile clip connected to the RED servo wire → micro:bit 3V
- Crocodile clip connected to the BROWN servo wire → micro:bit GND

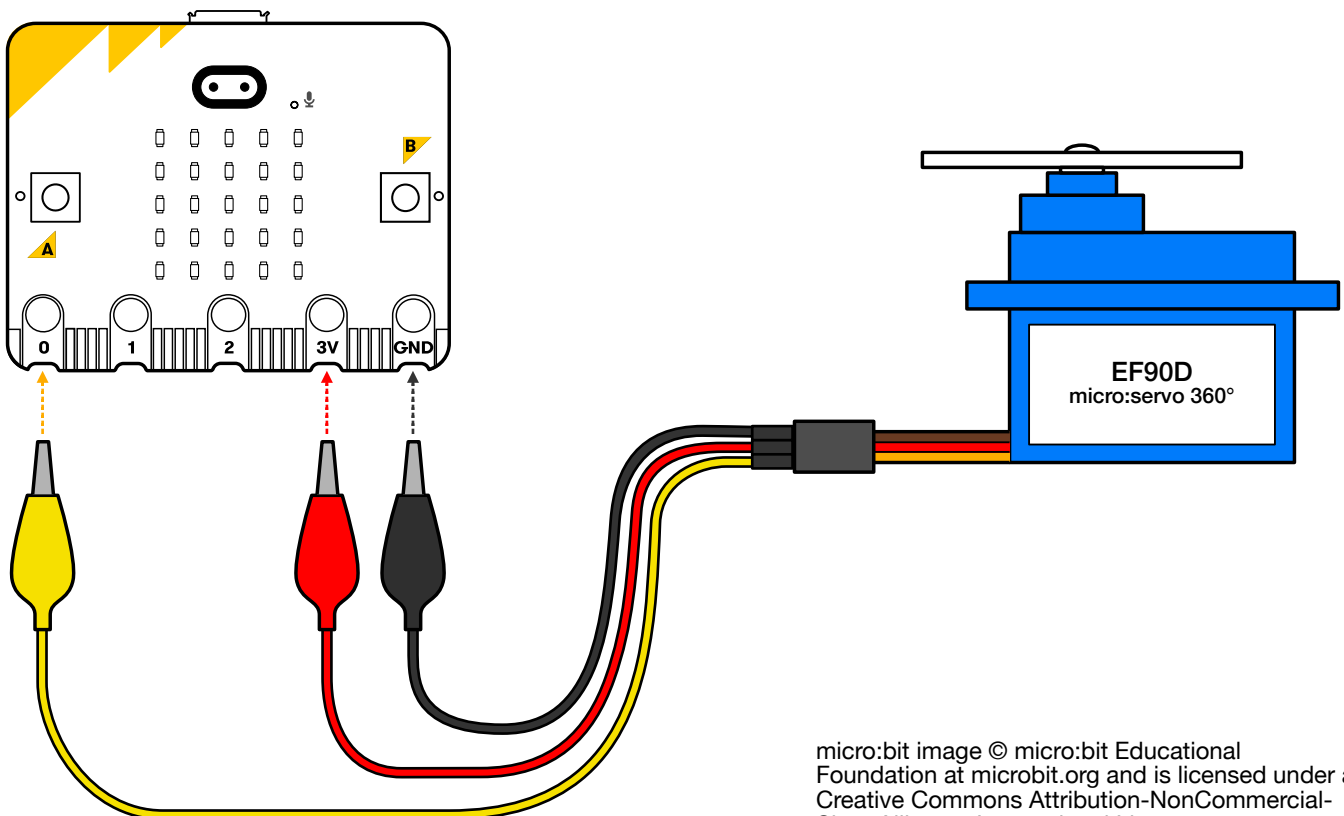
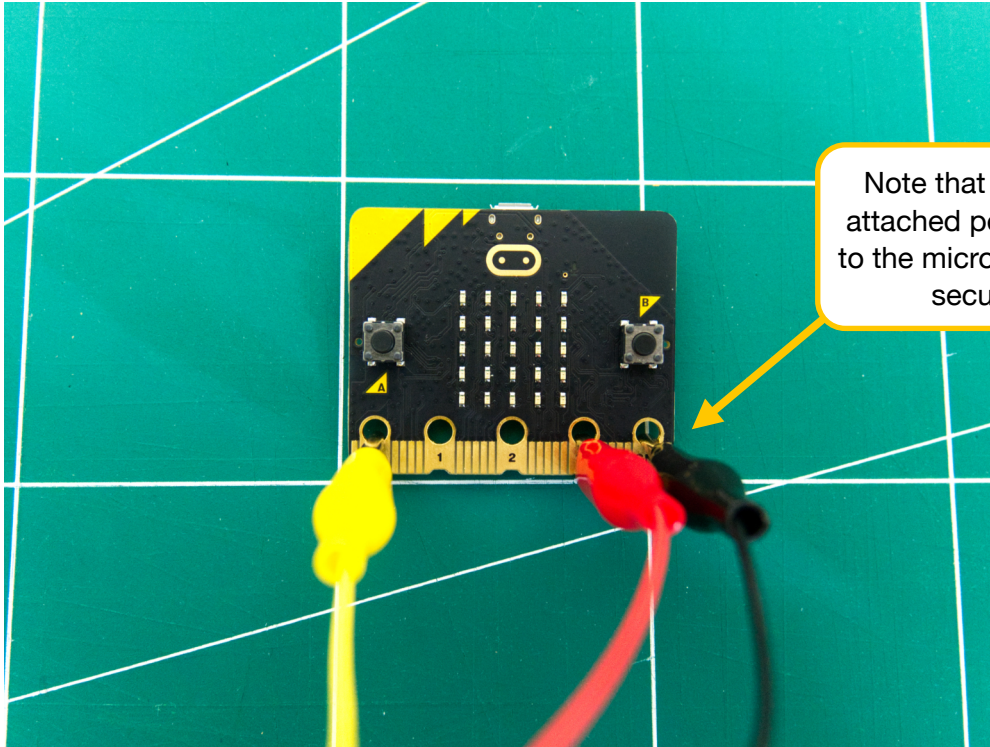

micro:bit image © micro:bit Educational Foundation at microbit.org and is licensed under a Creative Commons Attribution-NonCommercial-ShareAlike 4.0 International License

22

Connect the micro:bit to your computer using the micro USB cord. The cord will be used both to transfer the code and to supply power to the micro:bit and the servo.

23

Get the code from here:

https://makecode.microbit.org/#pub:_34Xe7VJ4zL3p

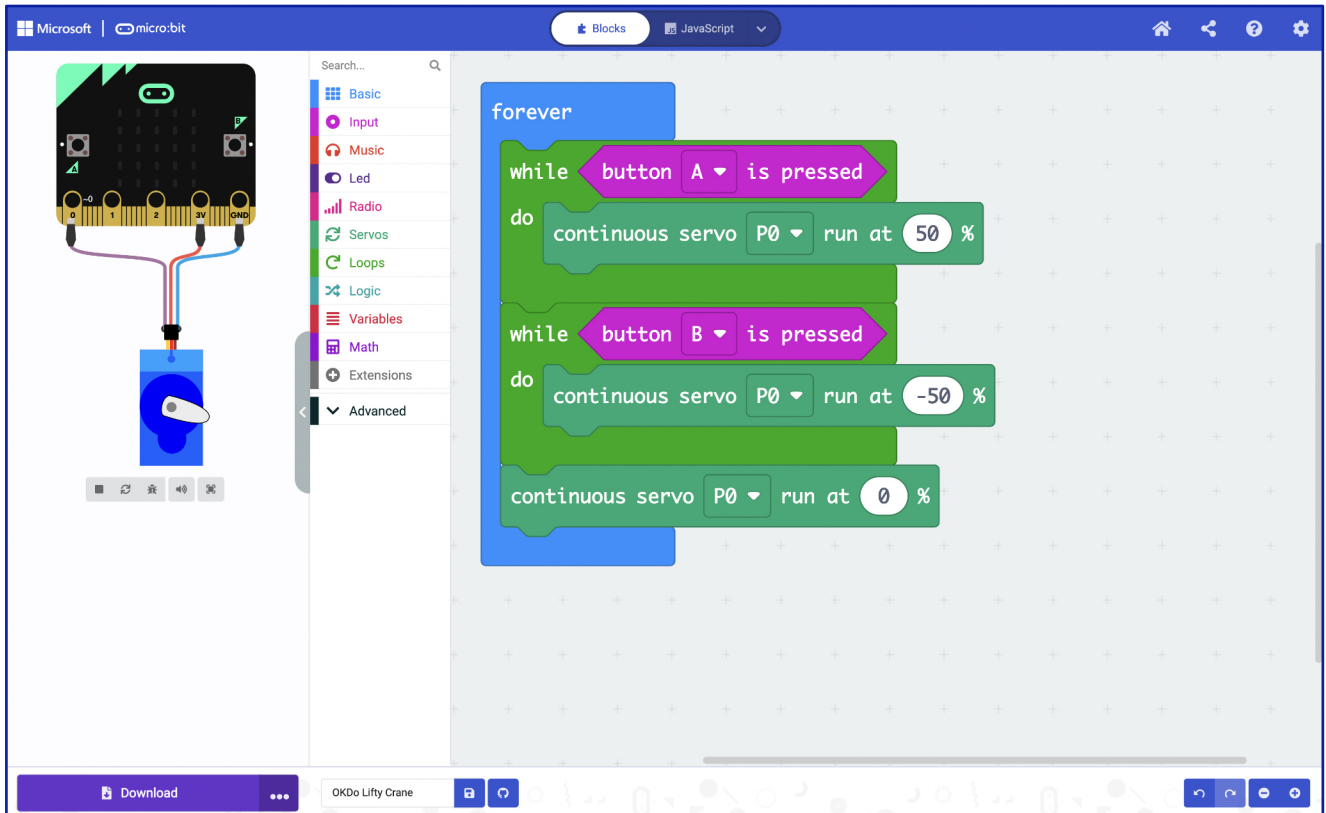
**24**

Upload the code to the micro:bit using the following instructions (choose in the instructions what type of computer and browser you're using for more specific directions):

<https://microbit.org/get-started/first-steps/set-up/>

or

<https://makecode.microbit.org/device/usb>

25

Test it out! Press the A button to spin the drum one way and the B button to spin the other. Here's a video of it in action:

<https://youtu.be/ocuZRu472Mw>

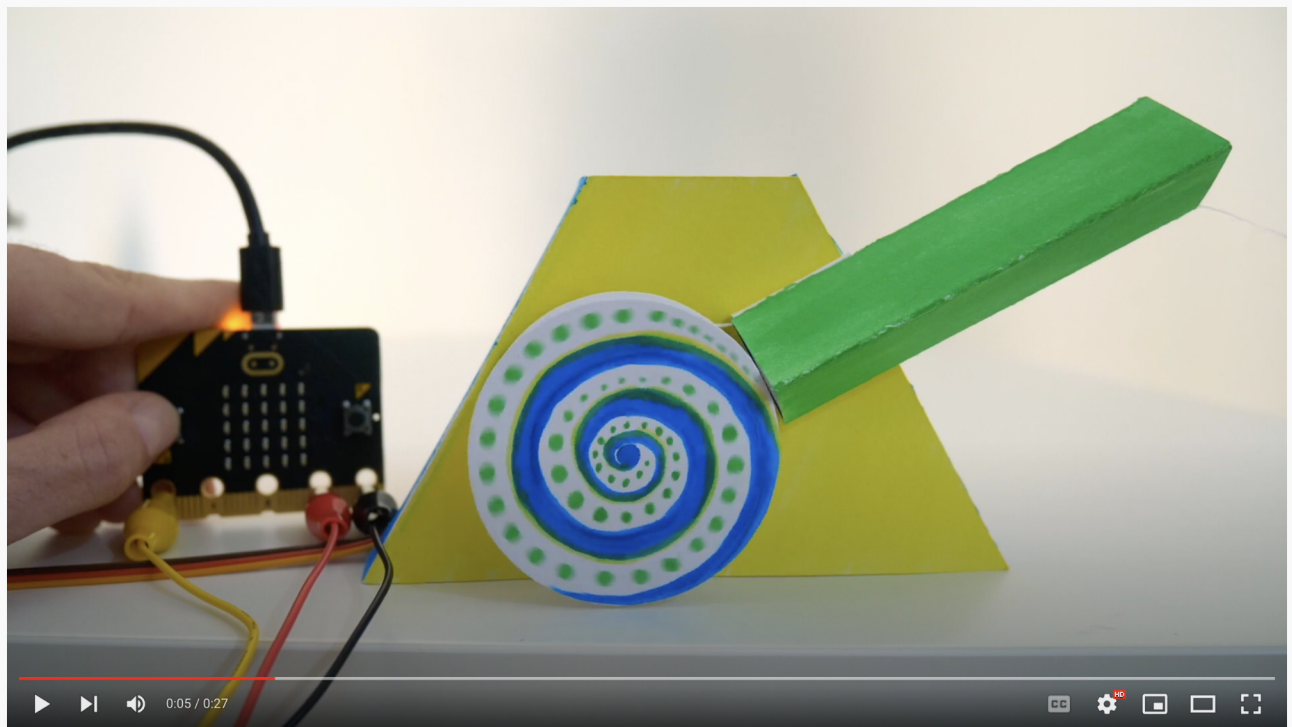

26

Experiment! Can you change the MakeCode to make the servo run faster? Slower? What about using different inputs besides the A and B button? How much weight can you lift with the Lifty Crane before it stops working?