

1139_0 Mechanical Drawing

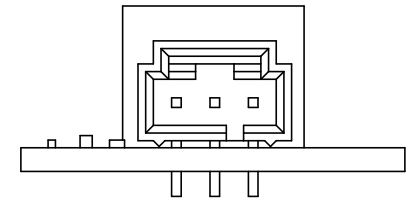
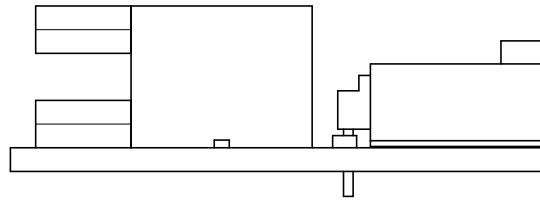
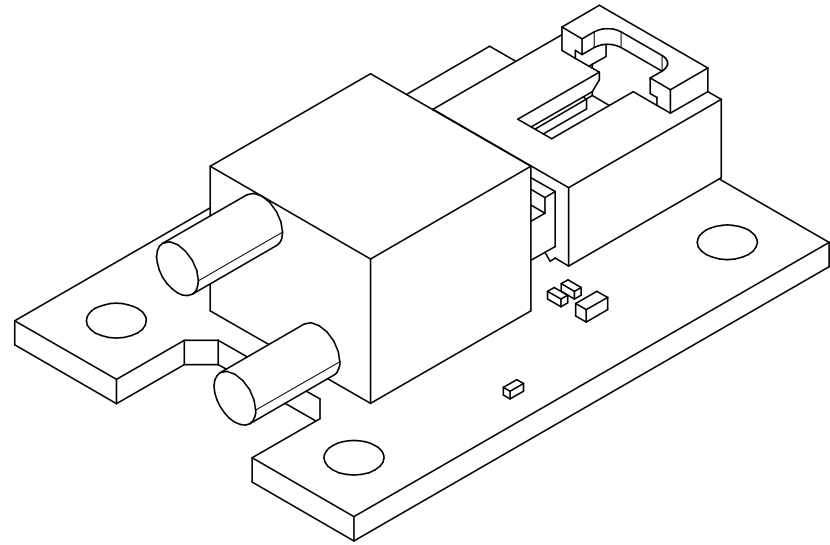
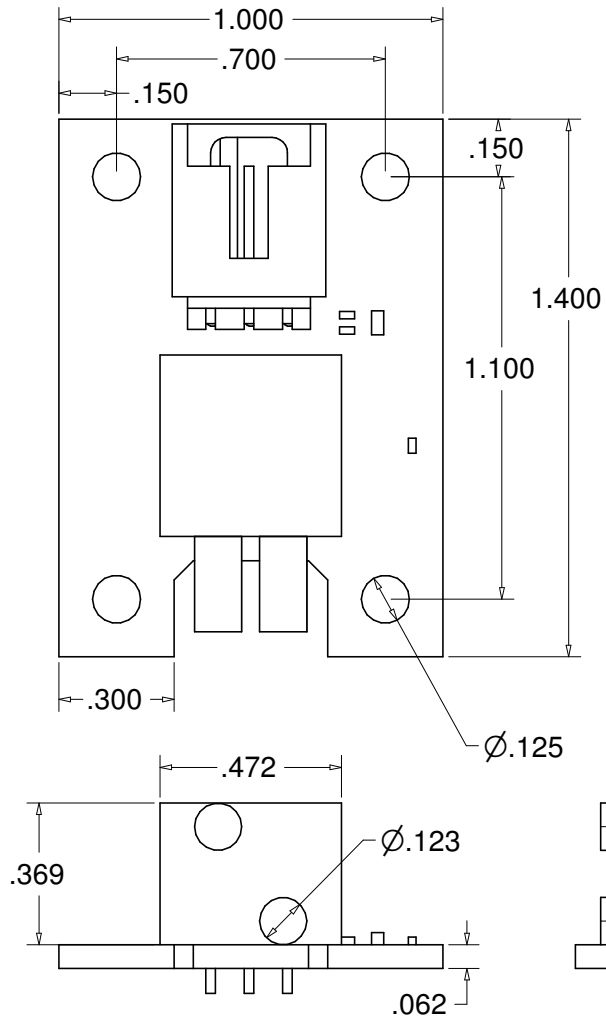

Scale 1: 0.5
Units are in Inches