

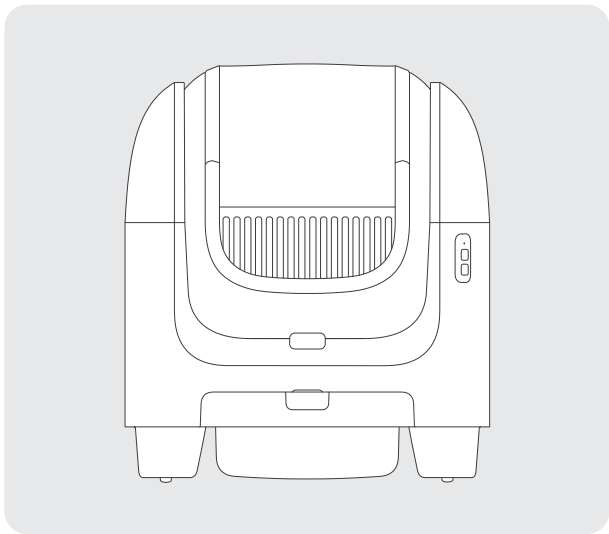

PET MARVEL®



Smart Cat Toilet [C1]

Welcome

Great thank you for choosing us!

This manual is hereby to guide you to fully understand and quickly install this product, meanwhile provide detailed information about usage and maintenance to help you achieve the best product experience.

If you have any questions during use, please feel free to contact User Service Department:

✉ customerservice@petmarvel.com

Or directly contact the distributor who you bought this product from.

Scan the QR code below or search "PET MARVEL" in App Store/Google Play to download our App to unlock more features.



Scan to download App



Scan to view tutorials on use

**TECHNOLOGY
CARES FOR PET
HEALTH**

1 Information For Users

- Please read this product manual carefully before use and keep it properly. Once installed or used, it implies that you have read and accepted the following safety guidelines.
- Our company is not responsible for any accidents or losses caused by improper operation, nor does it assume any legal liability.
- The right to interpret and modify this manual belongs to our company.

Safety Guidelines

*** Failure to comply with the following terms may result in the product not functioning properly or other unforeseen losses.**

*** Please follow this manual for installation and usage of the device carefully. Product malfunctions or damage caused by actions outside of this manual are not covered under warranty.**

- This device is prohibited for use by pets under 6 months old or weighing less than 1.5 kg.
- This product is for indoor use only.
- Do not use this device in places with direct sunlight, such as balconies.
- Ensure power cords are properly concealed or stored to prevent pets from chewing on them, which could cause electric shock or other dangers.
- Do not clean the main body of the device with water to avoid damage to internal electronic components.
- Use only the original power adapter provided with the device. Using a non-original adapter may cause damage due to power mismatch or other safety hazards.
- If the power adapter or power cord is damaged (including fraying, cracking, etc.), immediately stop using the device and contact customer service for repair or replacement.
- Ensure the device is placed on a level surface to prevent inaccurate weighing or other malfunctions.
- Do not sit or stand on the device.
- If you do not use this product for an extended period, unplug it to ensure electrical safety.
- Children should use the device under adult supervision.
- If you are going to leave home for an extended period, please check the litter level in the product's drum as well as the waste bin before you go.
- Do not place fingers in any gaps or openings of the product to avoid injury.
- Clean or maintain the device only when it is turned off or unplugged.

- Do not use the device in an environment below 0°C or above 40°C.
- Keep away from open flames and high heat sources.
- Do not disassemble, modify, or repair the device yourself; doing so will void all warranty and after-sales service rights.
- This appliance can be used by children aged from 8 years and above and persons with reduced physical, sensory or mental capabilities or lack of experience and knowledge if they have been given supervision or instruction concerning use of the appliance in a safe way and understand the hazards involved
- Children shall not play with the appliance
- Cleaning and user maintenance shall not be made by children without supervision
- The appliance is only to be used with the power supply unit provided with the appliance.

This equipment has been tested and found to comply with the limits for a Class B digital device, pursuant to Part 15 of the FCC Rules. These limits are designed to provide reasonable protection against harmful interference in a residential installation. This equipment generates uses and can radiate radio frequency energy and, if not installed and used in accordance with the instructions, may cause harmful interference to radio communications. However, there is no guarantee that interference will not occur in a particular installation. If this equipment does cause harmful interference to radio or television reception, which can be determined by turning the equipment off and on, the user is encouraged to try to correct the interference by one of the following measures:

- Reorient or relocate the receiving antenna.
- Increase the separation between the equipment and receiver.
- Connect the equipment into an outlet on a circuit different from that to which the receiver is connected.
- Consult the dealer or an experienced radio/TV technician for help.

"This device complies with part 15 of the FCC Rules. Operation is subject to the following two conditions: (1) This device may not cause harmful interference, and (2) this device must accept any interference received, including interference that may cause undesired operation."

Radiation Exposure Statement:

1.This equipment complies with FCC/IC radiation exposure limits set forth for an uncontrolled environment.

This equipment should be installed and operated with minimum distance 20cm between the radiator & your body.

2.The device has been evaluated to meet general RF exposure requirement

2 Product Information

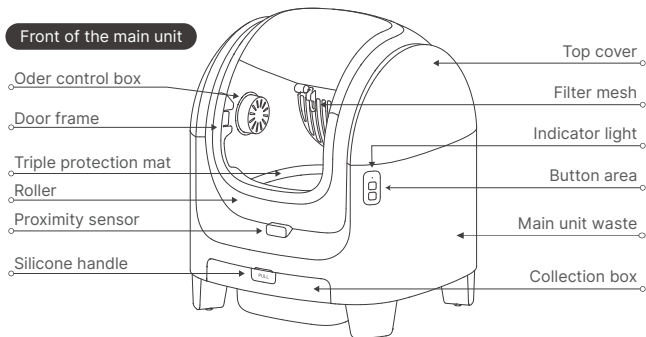

Front of the main unit

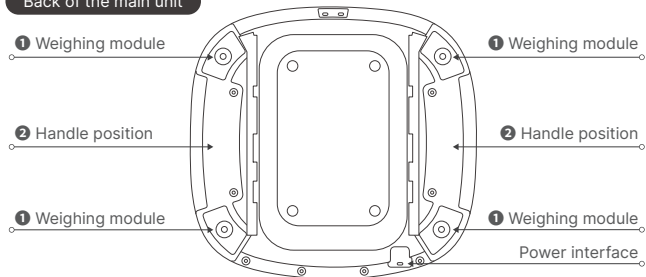

Back of the main unit



Button Instructions

Button	Operation	Status
 <p>Network Configuration / Reset</p>	Press and hold for 7 seconds until you hear a "beep" sound	Device network reset successful
	Double-click to hear a "beep" sound	Reset (simultaneously perform weighing calibration and litter leveling)
	Single-click to hear a "beep" sound	Pause operation
 <p>Clean / Dump litter</p>	Long press for 5 seconds until you hear a "beep" sound	The device executes one-time litter dumping action
	Double-click to hear a "beep" sound	The device performs one-time cleaning action
	Single-click to hear a "beep" sound	Pause operation
	After pressing two buttons simultaneously for 3 seconds, a drip will sound	Child lock on/off

Indicator Light

Status	Working Status	Description
White Light Flashing	WiFi Not Connected	Not connected to WiFi, the white light will flash for 30 minutes by default when turned on; If the distribution network is not completed within 30 minutes, Press and hold the 7S "Distribution/Reset" button to re-enter the waiting network state.
White light steady	Wi-Fi connected	Device status normal.
Red Light Flashing	Full litter reminder	The waste bin is full. Please promptly bag the garbage and replace it with a new garbage bag.
Red light steady	Device malfunction	At this time, the device may have operational faults. Please refer to the app prompts for self inspection of the device; If the product still cannot be used normally after self inspection, please contact after-sales customer service.
Orange Light Flashing	Parts not properly assembled	At this time, the device may have operational faults. Please refer to the app prompts for self inspection of the device.
Green light steady	The device detects movement nearby	For pet safety, the operation is paused.
White light pulsating	Device upgrading	At this time, the device is undergoing a firmware upgrade. Please be patient and wait for the upgrade to complete.

3 Packing List

Note

- After opening the product packaging, please confirm whether the product is intact, and check the accessories against the picture to confirm if they are complete.
- Additionally, as the product may be updated and iterations, some accessories may be adjusted, so please refer to the actual product.

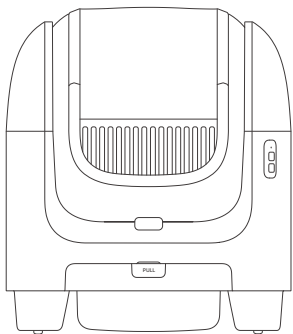

Main Unit*1



Instruction Manual*1



Odor Control Box*1

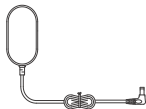

Power Adapter*1



Specialized garbage bag *1 roll

4 Product installation

Scan the code to view the device usage tutorial

This tutorial includes product installation, functional use, network configuration, cleaning and maintenance, and more.



Scan the code to view the device usage tutorial

Remove the collision prevention foam

Remove the anti-collision foam pieces between the roller barrel and the base, between the top cover and the roller barrel.

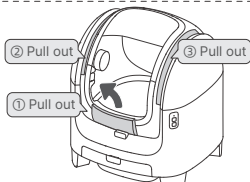

Product Placement Standard

Place the product on a level surface against a wall, ensuring no items are stacked on top.

Maintain a minimum distance of 5cm between the product and surrounding objects on the sides and back, and a distance of at least 50cm in front for proper operation.

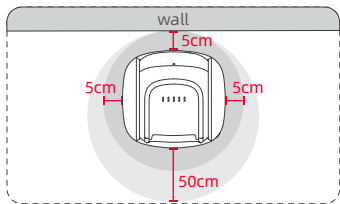

Installing the Odor Control Box

1 Take out the Odor Control Box, follow the diagram, unscrew the top cover, and peel off the top sealing film.

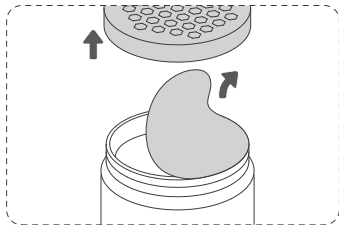

2 Replace the top cover.

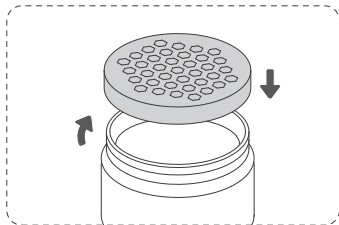

3 As shown in the diagram, rotate the Odor Control Box counterclockwise and remove it from the device.

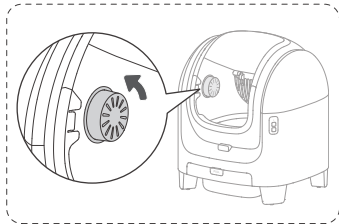

4 As shown in the diagram, please insert the top cover of the Odor Control Box inward into the odor control box.

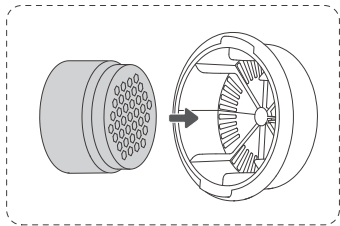

5 Align the clasp of the odor control box with the left slot of the roller, rotate clockwise, and complete the installation of the odor control box.

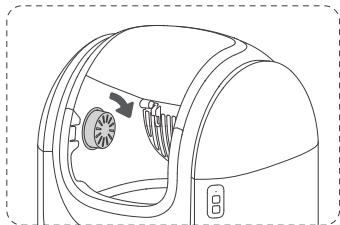

Install dedicated garbage bags

As shown in the diagram, correctly install the dedicated garbage bag into the collection box.

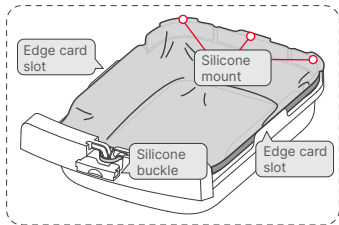

- 1** Pull out the entire waste collection box assembly.

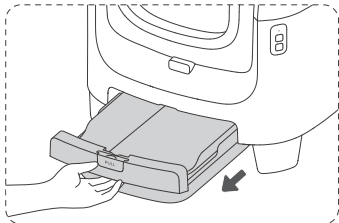

- 2** Pull the silicone buckle of the box outward.

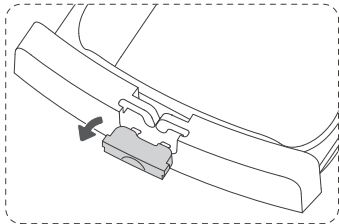

3 As shown in the diagram, press the garbage bag drawstring down from the slot to the bottom and pull it open on both sides, then clip it into the limit slots on both sides.

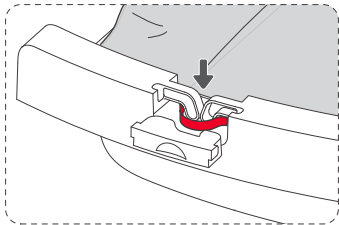

4 As shown in the diagram, pull up three silicone buckles, press the edge of the garbage bag between the silicone buckle and the edge slot, and then release the silicone buckle.

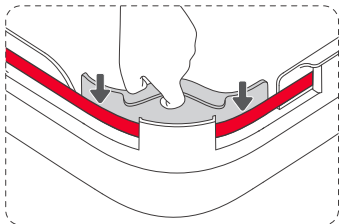

5 As shown in the diagram, press the edge of the garbage bag into the slots on both sides of the collection box.

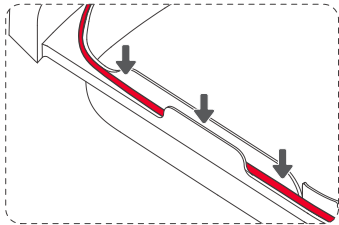

6 Press the silicone buckle inward and flatten the garbage bag to fit it against the bottom of the collection box.

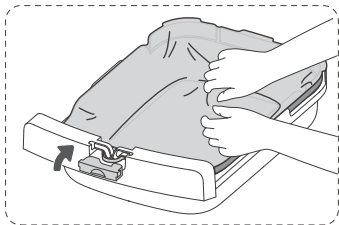

7 After completing the above steps, push the entire waste collection box assembly inward into the main body. When you hear a "beep" sound, the installation of the dedicated garbage bag is complete.

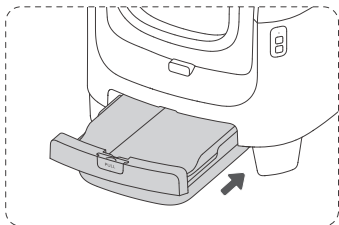

5 Product Usage

Connect the power supply

Remove the power adapter, connect it to the bottom power socket on the back of the host, and then connect the adapter to the socket to power on the device.

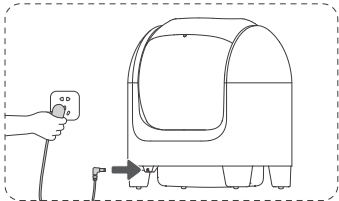

Installation status self inspection

Before using the product, please confirm:

- ① All accessories have been installed in place as instructed.
- ② The device is connected to a power source and the indicator light is on.
- ③ The location of the device has good WiFi signal coverage.
- ④ Place the device on a level ground (do not place the device on soft objects such as carpets).

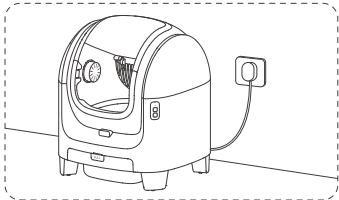

Device Disablement Instructions

Do not operate any settings when cat is inside.

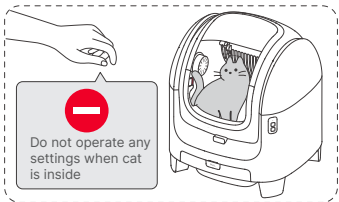

Add cat litter

- 1 Add cat litter into a rolling bucket.

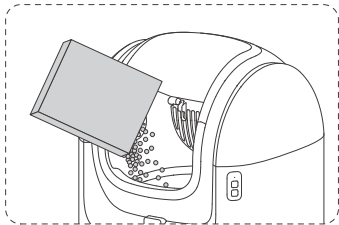

- 2 Double click the reset button to perform the cat litter smoothing action.

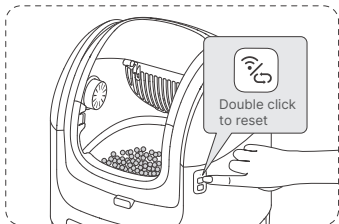

Suggestion for using cat litter

- The cat litter level shall not be higher than the MAX line or be lower than the MIN line;
- This device is compatible with several types of cat litter, including mineral sand, mixed sand, and tofu sand;
- To improve equipment cleaning efficiency, it is recommended to use cat litter specifically designed for this device, which can clump faster, deodorize better, and save more usage;

Note: This device does not support crystal cat litter.

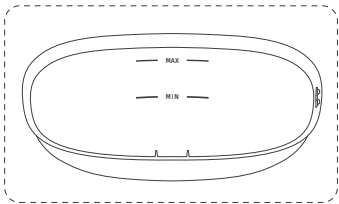

Equipment dumping litter

1 Disassemble door frame

As shown in the diagram, press the protrusions on both sides of the door frame, while facing outward, and remove the door frame.

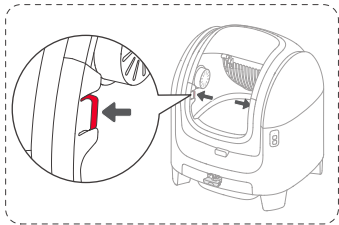

2 One click to dump litter

Press and hold the "Clean/Pour litter" button for 5 seconds, and the device will automatically pour all cat litter into the collection box.

Attention:

- 1 Please ensure that there is sufficient space in the waste bin and the amount of cat litter in the rolling bucket is lower than the MAX line, and then perform a one click sand cleaning operation to avoid overflow or sand leakage.
- 2 To avoid interference with the device, please do not allow cats to approach or use the device during the sand dumping process.

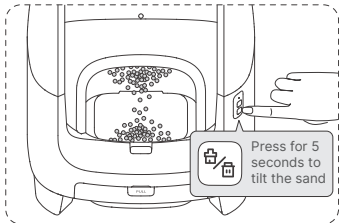

3 Door frame installation

As shown in the diagram, follow the limit diagram and install the door frame into the drum buckle.

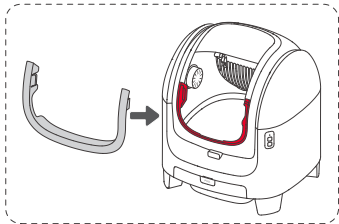

Garbage bag packing

1 As shown in the diagram, pull the silicone buckle of the box outward.

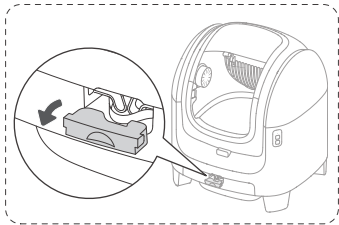

2 Hook the garbage bag drawstring and pull it outward until the garbage bag has completed the drawstring closure.

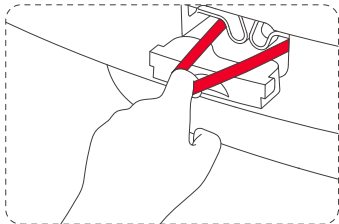

3 Pull out the collection box and remove the packaged garbage bag.

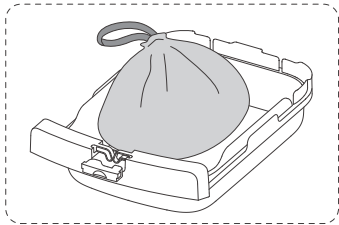

6 Distribution network and usage

Download the App

·Scan the QR code icon or search for 'PET MARVEL' in the app store, download the App, and register to log in.

·Users who have installed the App will directly enter the device's network configuration page after scanning the code.

Equipment network

- 1 Connect your phone to your home wireless network (this product only compatible with 2.4GHz Wi-Fi networks).
- 2 Open the "PET MARVEL" app, click "Add Device", and enable Bluetooth and location permissions on your phone to automatically search for the device. Follow the process shown in the app to complete the device networking operation.

*If the device cannot be found, please press and hold the "Network Configuration/Reset" button for 7 seconds. The indicator light will start flashing white, indicating that the device network reset has been successful. At this time, you can complete the device network configuration operation according to the steps of 1 and 2.



Scan to download App



Scan to view tutorials on use

APP Function Introduction

The app can record the weight of cats, the number of times they use the toilet, the amount of time they use the toilet, and the duration of each use.

Attention: Due to product functionality updates and iterations, please refer to actual usage on the app page.

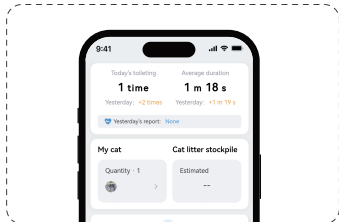

7 Maintenance and Care

Power off the device

Before performing device maintenance, be sure to unplug the power adapter from the socket to ensure the device is powered off.

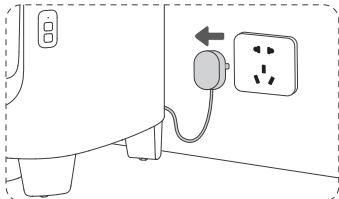

Detachable component cleaning

Disassemble the top cover

As shown in the diagram, remove the upper covers on both sides of the body upwards.

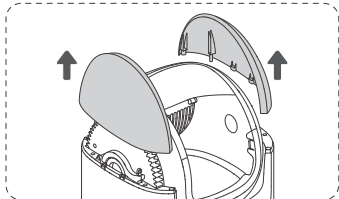

Disassemble the drum

1 Pinch the knob and bottom handle, lift them up, and rotate the drum lock back to the bottom.

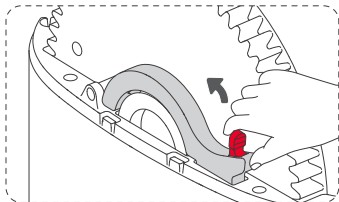

② As shown in the diagram, remove the drum upwards.

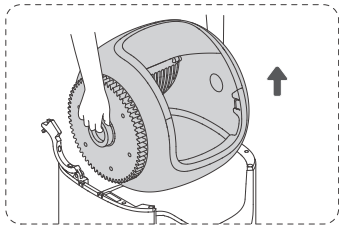

Disassemble the Filter screen

Pinch the deformed area on the left side of the filter, pull outward, and remove the filter.

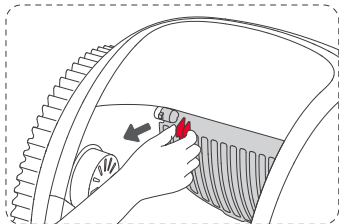

Cleaning of Detachable Components

*Clean as Needed

The upper cover, drum and filter screen removed according to the above steps can all be rinsed with water. After cleaning, please dry the above accessories and set them aside.

Attention: The device body contains a large number of electronic components, and should not be directly rinsed with water, otherwise it may cause equipment damage.

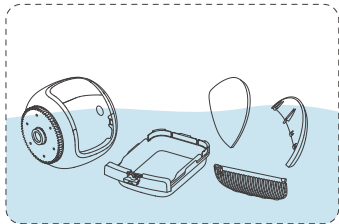

Main Unit Cleaning

Mainframe maintenance *Clean as Needed
Regularly use a soft dry cloth to wipe the device body.

Attention: The device body contains a large number of electronic components. It is prohibited to rinse with water, otherwise it may cause equipment damage.

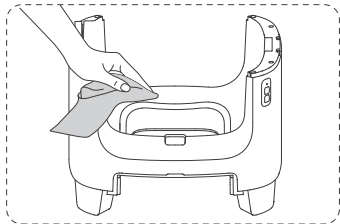

Cleaning the "proximity sensor"

*Clean as Needed

As shown in the diagram, regularly use a soft dry cloth to wipe the proximity sensor in front of the device to avoid dust/dirt blocking and affecting the normal use of the device.

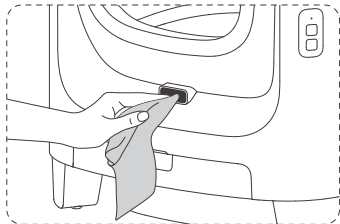

Clean the "full-box sensing lens"

*Clean as Needed

As shown in the diagram, regularly use a soft dry cloth to wipe and clean the bottom of the device with full sensing lenses to avoid dust/dirt blocking and affecting the normal use of the equipment.

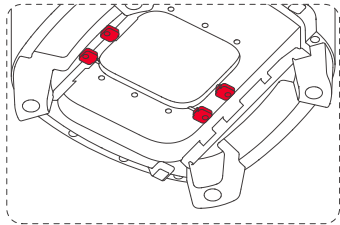

Install filter screen

Press the filter screen shaft into the right side shaft of the drum, then pinch the protrusion of the filter screen and press it into the left side shaft of the drum.

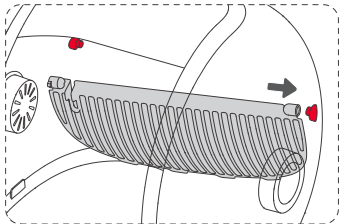

Install the drum

1 Return the drum downwards as shown in the diagram.

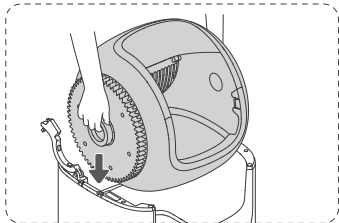

2 Hold the dial and the bottom handle, lift upwards, lock the drum by rotating it forward to the bottom.

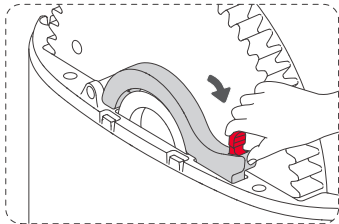

Install the top cover

As shown in the diagram, reinstall the top covers on both sides. After installing the left side cover, you will hear a "beep" sound.

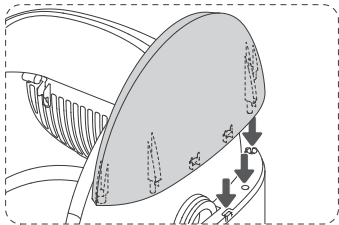

Install the waste collection box

As shown in the diagram, push the entire waste bin inward into the main body. When you hear a "beep" sound, the waste bin installation is complete.

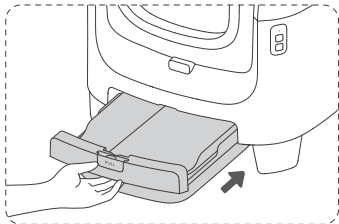

8 Product specifications

Product Name: Smart Cat Toilet [C1]
Product Model: NDSL001
Main Material: ABS, PP
Product Size: 537*509*615mm

N.W.: ≈9.1kg
Connect Method: Wi-Fi (2.4GHz)
Input: 12V ⎓ 2A
Product Grade: Qualified

This device includes a wireless transmission module with model approval code
CMIIT ID: 2021DP11459 (module).

9 Troubleshooting Table

Fault Code	Fault Description	Fault Cause	Solution
E1	Main motor failure	Motor Damage / False Alarm	Please unplug the power adapter from the socket, confirm that the device is powered off, and then reconnect the power adapter, If the issue persists, please contact customer service for further assistance.
E2	Cleaning Hall sensor abnormality	Sensor Damage / False Alarm	Please unplug the power adapter from the socket, confirm that the device is powered off, and then reconnect the power adapter, If the issue persists, please contact customer service for further assistance.
E3	Zero position Hall sensor abnormality	Sensor Damage / False Alarm	Please unplug the power adapter from the socket, confirm that the device is powered off, and then reconnect the power adapter, If the issue persists, please contact customer service for further assistance.
E4	Abnormal Weighing Sensor	Uneven placement of equipment /interference from foreign objects near the equipment	Please check if the machine is placed flat and if there are any objects interfering with the bottom being placed horizontally. After confirming that the above two items are correct, perform the equipment reset action.

Fault Code	Fault Description	Fault Cause	Solution
E5	Abnormal Weighing Readings	Excessive/Negative Weighing Readings	Double-click the "Network Configuration/Reset" button to reset the device. If the issue persists, unplug the power adapter from the socket to ensure the device is powered off. Then reconnect the power adapter. If the issue still cannot be resolved, please contact customer service.
E6	Full Bin Infrared Abnormality	Sensor Damage / False Alarm	Please unplug the power adapter from the socket, confirm that the device is powered off, and then reconnect the power adapter, If the issue persists, please contact customer service for further assistance.
E7	Anti-Pinch Infrared Abnormality	Sensor Damage / False Alarm	Please unplug the power adapter from the socket, confirm that the device is powered off, and then reconnect the power adapter, If the issue persists, please contact customer service for further assistance.
/	Upper cover not installed	The upper cover is not installed properly	Install the top cover into place. You will hear a "beep" sound.
/	The toilet box is not installed	The waste collection box is not installed properly	Install the waste collection box into place. You will hear a "beep" sound.

Fault Code	Fault Description	Fault Cause	Solution
/	During the working process, the drum stops scrolling	Pets approaching	The pet leaves and the machine will continue to work after waiting for 5 seconds.
/	The toilet box is not full, but it shows as full	The toilet bag is not smoothed or covered by dust Infrared radiation sensor above the toilet box	Pull out the toilet box, flatten the toilet bag, and then reinstall it/wipe the infrared sensor above the toilet box.
/	The device keeps showing that the cat is using the toilet	No reset action was performed after adding cat litter	Double click the reset button to perform a reset action.
/	The drum cannot return to its original position.	Dust obstructs the infrared radiation sensor above the toilet box	Wipe the infrared radiation sensor above the toilet box.
/	There are no pets at the device entrance. But App shows that the pet is approaching	Dust blocking in front of the entrance lens	Wipe the entrance lens with a dry cloth.
/	Multiple network failures	Operational issues/equipment malfunctions	Please follow the instructions in the "View Solution" section of the app to troubleshoot. If it has not been resolved yet, please contact after-sales promptly.

Fault Code	Fault Description	Fault Cause	Solution
/	Unable to install the Odor Control Box	Installation step error	Follow the instructions and correct steps to try again. If installation still fails, please contact after-sales customer service.

10 Warranty Terms

Dear customers, thank you for purchasing this product, please read the below warranty terms carefully before using:

12-month Warranty & Lifetime Customer Support

Only apply to eligible purchases made directly from the Pet Marvel authorized distributors. Warranty coverage applies to the original owner and the original product only. And is not transferable.



The following conditions are not covered by the warranty:

- Any malfunction or defect caused by improper use of environment or conditions;
- Any fault or defect caused by improper installation, misuse, unauthorized maintenance, force majeure events, or other external reasons;
- Any fault or defect caused by the use of non-original fittings or accessories;
- The product has exceeded the warranty period;
- Other failures or damages caused by none of the product design, technology, manufacturing process, or quality problems;
- Normal fading, wear and tear, or consumption during the use of the product;
- Not able to provide a valid purchase certificate.

For warranty service and more information, please get in touch via Email: customerservice@petmarvel.com



Note: Pictures on this brochure are for reference only, and the product is subject to the real object.

4		3		2		1				
						版本号	发布日期	变更内容		执行者
						V1.0	2024-05-28	新版发行		张明
						V1.1	2024-06-13	封底文案调整, 修改07页开箱方式		张明
						V1.2	2024-07-10	17页: 更改App下载二维码	张明	
A		A		A		A			A	
物料代码	XXXXXXXX	物料名称	神舟C1·智能猫砂盆-英文	产品型号	NDSL001	 上海乌语花香宠物有限公司				
尺寸	110*110mm(32页)	材质	108g哑粉纸	备注		设计	张明	日期	2024-07-10	
公差	±1mm					审核		日期		
印刷颜色	CMYK+PT185C 	表面工艺	N/A			批准	XXX	日期	XXXX-XX-XX	
4		3		2		1				