

# *Jueying Lite3 Venture*

*User Manual V2.0.0-0*

*2026/02/27*

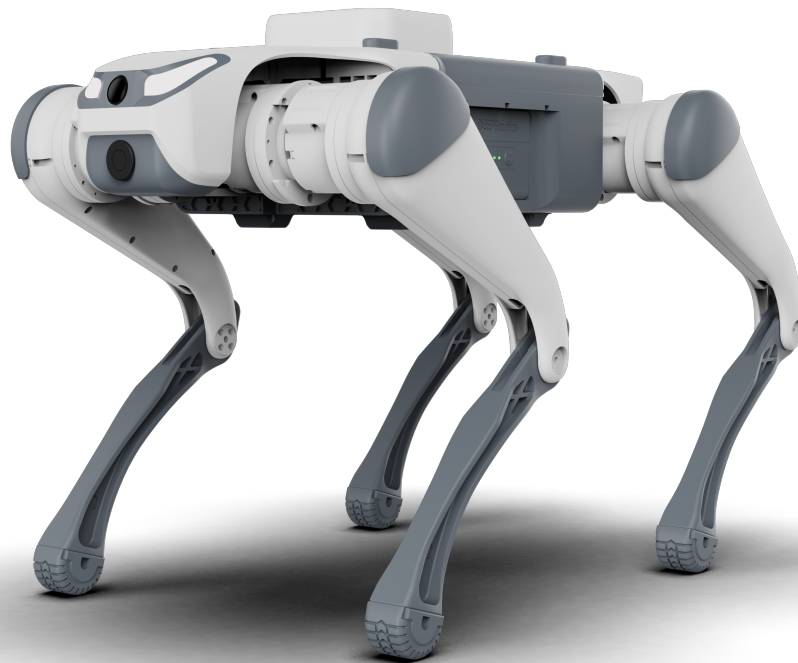

**DEEP**Robotics



## Statement

- This manual is the information asset owned by Hangzhou Yunshenchi Technology Co.,Ltd. (hereafter referred to as DEEP Robotics) and any reproduction of part or all of this manual is strictly prohibited without the permission of DEEP Robotics.
- This manual explains the basic components, transportation and storage, specific operations, exception handling, and technical specifications of Jueying Lite3. Be sure to read and understand this manual carefully before operating the robot.
- Basic information on safe use is described in detail in the "Reading Tips", so be sure to read this part thoroughly to ensure proper use.
- The diagrams and photographs in this manual are representative examples and may differ in detail from the product purchased.
- This manual may be modified as appropriate for product improvements, specification changes, etc.
- The contents of this manual do not exclude the possibility of misremembering or omission. If this manual is damaged or lost or if you have questions about the contents of this manual, please contact us promptly.
- Failure caused by unauthorized disassembly or modification of the product by the customer is not covered by our warranty, see "Service & Warranty" for details.

## Reading Tips

### Description of Symbol

Before use (installation, transportation, maintenance, inspection), please be sure to read and master this manual, and familiarize yourself with the equipment and safety matters before you start using it. The safety matters in this manual are divided into three kinds: "Caution", "Mandatory" and "Prohibition". Even the contents of "Caution" may have serious consequences depending on the situation, so any of these safety matters are extremely important and should be strictly observed.



#### Caution

Usage tips or operational recommendations. Improper using or operating the robot may cause damage to it.



#### Mandatory

Matters that must be observed.



#### Prohibition

Matters prohibited. Misoperation is dangerous and may cause injury to operators or damage to the robot.

### Download DEEP Robotics APP



Use "DEEP Robotics" APP to control the robot and scan the QR code to download and install it ([Download Center](#)). "DEEP Robotics" APP supports Android 6.0 or later, and does not yet support iOS.



### Get Help

For more resources to assist you in using Jueying Lite3 proficiently, you can also visit DEEP Robotics' corporate website: <http://www.deeprobotics.cn>.

## Important Safety Tips

	<p>Before starting the robot, please ensure that all people and objects present are more than 1 meter away from the robot to avoid collisions.</p>
	<ul style="list-style-type: none"><li>• When the robot passes through stairs or slopes, do not stand on the stairs, platforms, or slopes below the robot to avoid personal injury when it falls.</li><li>• When the robot swaying legs, shaking violently or other abnormal phenomena occur in use, press [<b>⑦STOP</b>] to activate the soft emergency stop protection, so that the moving robot enters a protective state. The robot will automatically get down. After identifying the problem, cancel Emergency STOP to operate the robot normally.</li></ul>

## FCC Statement

Please take attention that changes or modification not expressly approved by the party responsible for compliance could void the user's authority to operate the equipment.

This device complies with Part 15 of the FCC Rules. Operation is subject to the following two conditions:

- This device may not cause harmful interference, and
- This device must accept any interference received, including interference that may cause undesired operation.

This equipment complies with FCC radiation exposure limits set forth for an uncontrolled environment. This equipment should be installed and operated with minimum distance 20cm between the radiator & your body.

## EU Conformity Statement



Hereby, Hangzhou Yunshenchu Technology Co.,Ltd. declares that the radio equipment is in compliance with Directive 2014/53/EU.

## RF Exposure Information

- This device has been tested and meets applicable limits for Radio Frequency (RF) exposure.
- This equipment must be installed and operated in accordance with provided instructions and the antenna(s) used for this transmitter must be installed to provide a separation distance of at least 20 cm from all persons and must not be co-located or operating in conjunction with any other antenna or transmitter.

## Other Information

- This appliance can be used by children aged from 8 years and above and persons with reduced physical, sensory or mental capabilities or lack of experience and knowledge if they have been given supervision or instruction concerning use of the appliance in a safe way and understand the hazards involved, children shall not play with the appliance, cleaning and user maintenance shall not be made by children without supervision.
- This appliance contains battery cells that are non-replaceable.



- For the purposes of recharging the battery, only use the detachable supply unit provided with this appliance.
- If the appliance is to be stored unused for a long period, the batteries are removed.
- The supply terminals are not to be short-circuited.

# Content

<b>Statement</b>	<b>I</b>	3.1.3 Checking	15
<b>Reading Tips</b>	<b>I</b>	<b>3.2 Charging</b>	<b>16</b>
Description of Symbol	I	<b>3.3 Start</b>	<b>17</b>
Download DEEP Robotics APP	I	<b>3.4 Connection</b>	<b>17</b>
Get Help	I	<b>3.5 Reset to Zero</b>	<b>18</b>
<b>Important Safety Tips</b>	<b>II</b>	<b>3.6 Motion Control</b>	<b>18</b>
<b>1 Introduction</b>	<b>1</b>	<b>3.7 Action Options</b>	<b>18</b>
1.1 Overview	1	<b>3.8 Voice Command</b>	<b>19</b>
1.2 Product List	1	<b>3.9 Smart Sensing</b>	<b>20</b>
1.3 Part Name	2	3.9.1 Tracking	20
1.4 Main Specifications	3	3.9.2 Auto Stop	20
1.5 Interface	4	<b>3.10 Payload</b>	<b>21</b>
<b>2 Functions and Status</b>	<b>5</b>	<b>3.11 Emergency Operation</b>	<b>21</b>
2.1 Motion Mode and Gait	5	3.11.1 Emergency STOP	21
2.2 Description of Lighting	5	3.11.2 Fall Down & Get up	21
2.2.1 Charger	5	3.11.3 Overtemperature	22
2.2.2 Battery	5	3.11.4 Low Battery	22
2.2.3 LED Eyes	6	3.11.5 Other	22
2.3 "DEEP Robotics" APP	7	<b>3.12 Power Off</b>	<b>22</b>
2.3.1 Home Page	7	<b>4 Precautions</b>	<b>23</b>
2.3.2 Control Page	8	4.1 Work Environment	23
2.3.3 Flat Gait	9	4.2 Battery	23
2.3.4 RUG Gait	10	4.3 Other Precautions	24
2.3.5 Action List	11	4.4 Disposal	24
2.3.6 Settings Page	11	<b>5 FAQs</b>	<b>25</b>
2.3.7 AI Motion Mode	13	<b>6 Transport &amp; Storage</b>	<b>26</b>
2.4 Unlock AI Motion Mode	14	6.1 Transportation	26
<b>3 Operation</b>	<b>15</b>	6.2 Storage	26
3.1 Preparation	15	<b>7 Service &amp; Warranty</b>	<b>27</b>
3.1.1 Environment	15	7.1 After-Sales Service	27
3.1.2 Carrying	15	7.2 Warranty Policy	27
		7.3 Warranty Coverage	27
		7.4 Repair Instructions	28

# 1 Introduction

## 1.1 Overview

Jueying Lite3 is an intelligent quadruped robot with 12 degrees of freedom, featuring a variety of gaits and movements. Jueying Lite3 Venture provides SDK for motion control algorithm development and communication protocol, allowing users to re-develop as needed.

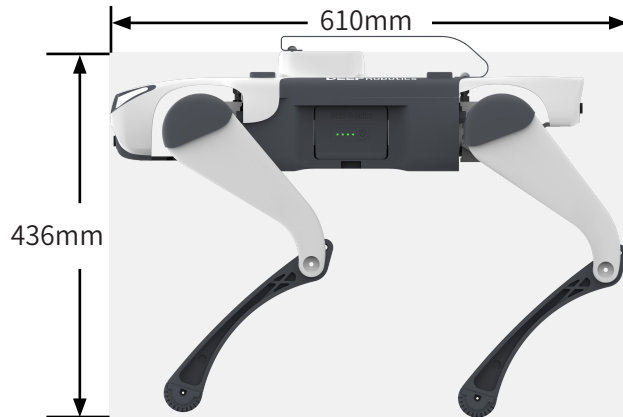
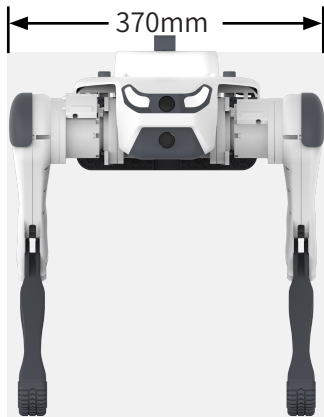

## 1.2 Product List

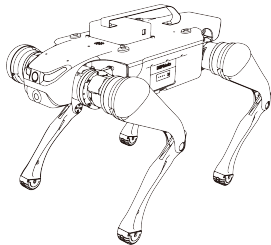

Robot×1  
(Battery not included)

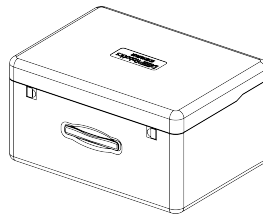

Transport Case×1

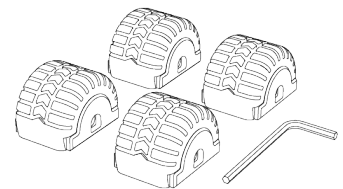

Sole Kit×1

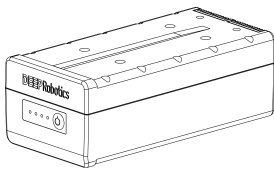

Replaceable Battery×1

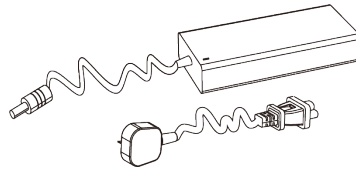

Charger×1

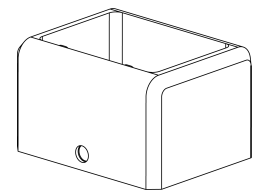

Charging Base ×1

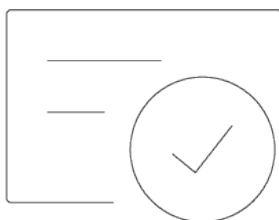

Qualified Certificatex1

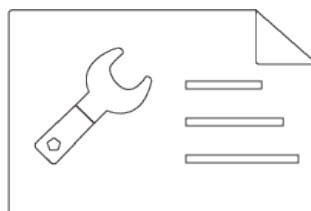

Warranty Card×1

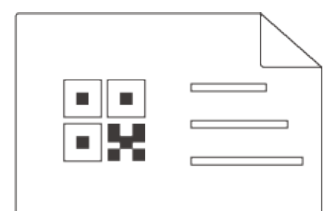

Fold-out Guidex1

### 1.3 Part Name

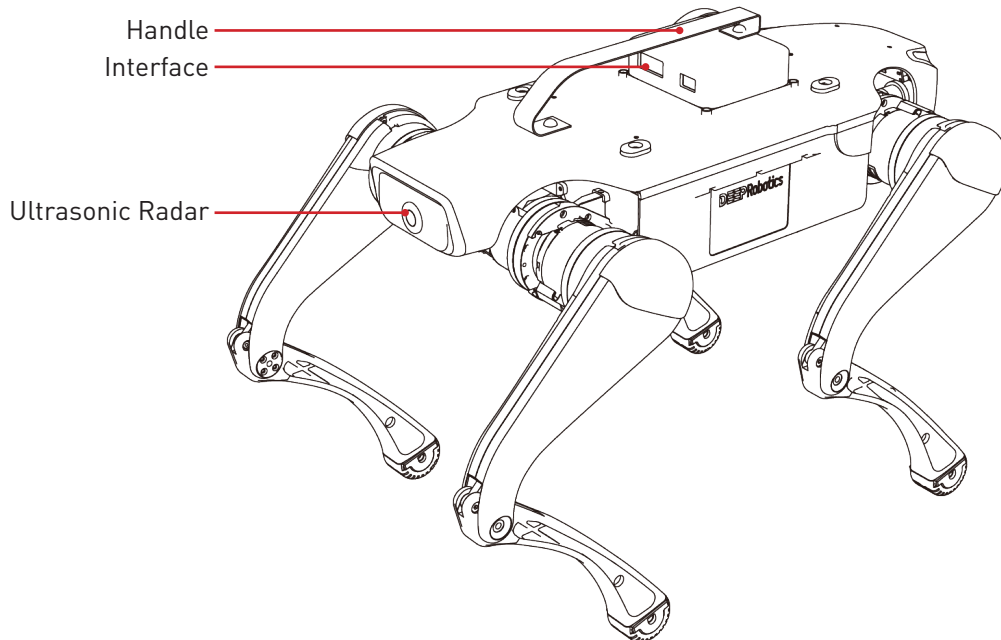
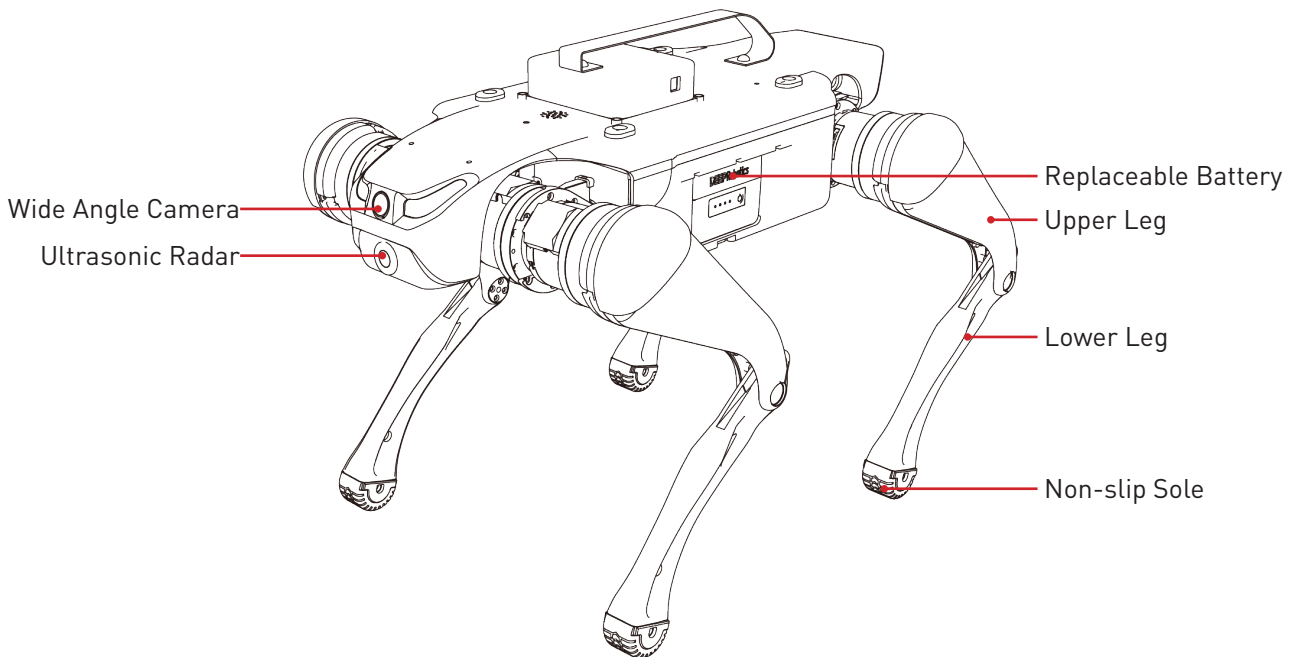

## 1.4 Main Specifications

Robot Dimensions	
Standing Size (Length × Width × Height)	610mm×370mm×436mm
Sitting Size (Length × Width × Height)	680mm×370mm×145mm
Weight	12.2kg
Perception System	
Wide Angle Camera	×1
Ultrasonic Radar	×2
Locomotion Parameters	
Slope	40°
Steps' Height	15cm
No-load Duration	1.5h~2h
Electric Parameters	
Battery Capacity	4.4Ah
Nominal Battery Voltage	28.8V
Charger Input	100V~240V
Charger Output	33.6V/5A
Charging Time	40min~1h
Other	
Operating Temperature	0°C ~40°C
WiFi Frequency Band	2412MHz-2472MHz;5150MHz~5250MHz; 5725MHz~5850MHz
WiFi Transmitter Power	2412MHz-2472MHz:17.77dBm
	5150MHz~5250MHz:14.87dBm
	5725MHz~5850MHz:13.89dBm

※ Data above are measured under ideal conditions, and the actual results may be biased.

## 1.5 Interface

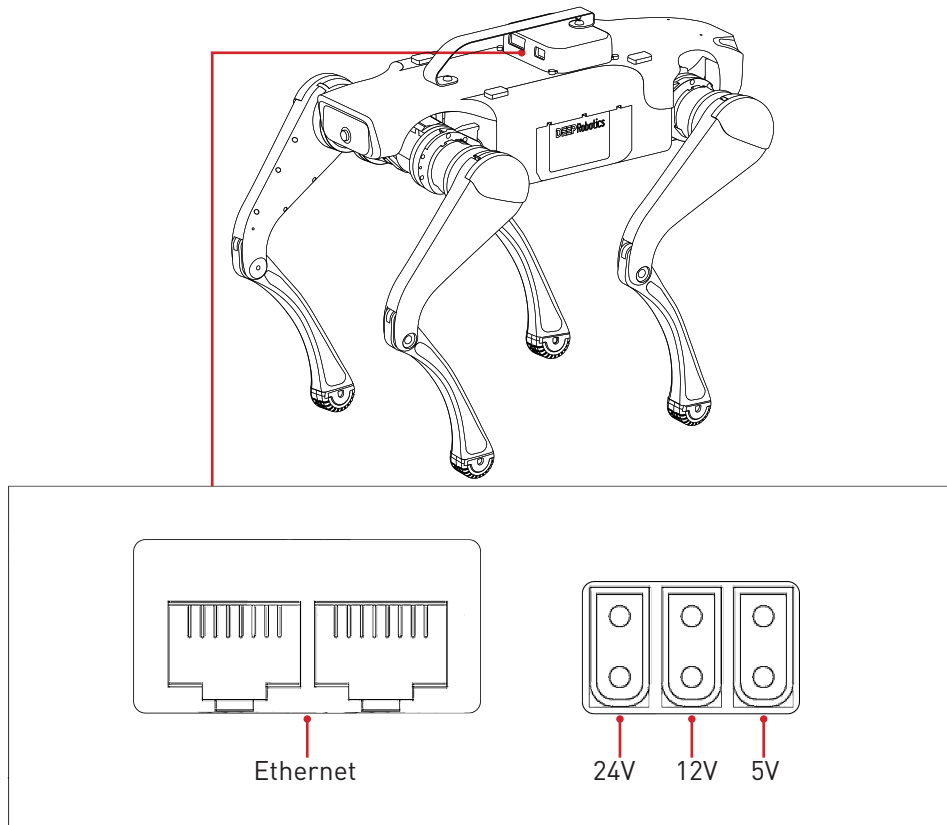

## 2 Functions and Status

### 2.1 Motion Mode and Gait

Mode	Description
Move	Choose a gait and push joysticks to make the robot move
Pose	Push joysticks to change pitch, roll, yaw and body height

Gait	Description
Flat	Adjust height and velocity of the robot in Flat gait
RUG	Choose an appropriate gait based on the actual terrain in RUG gait

### 2.2 Description of Lighting

#### 2.2.1 Charger

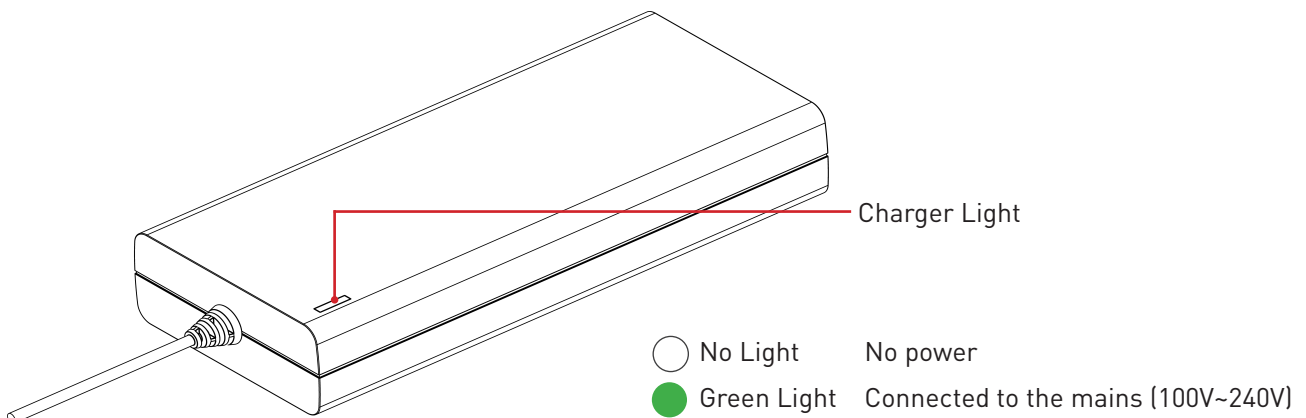

#### 2.2.2 Battery

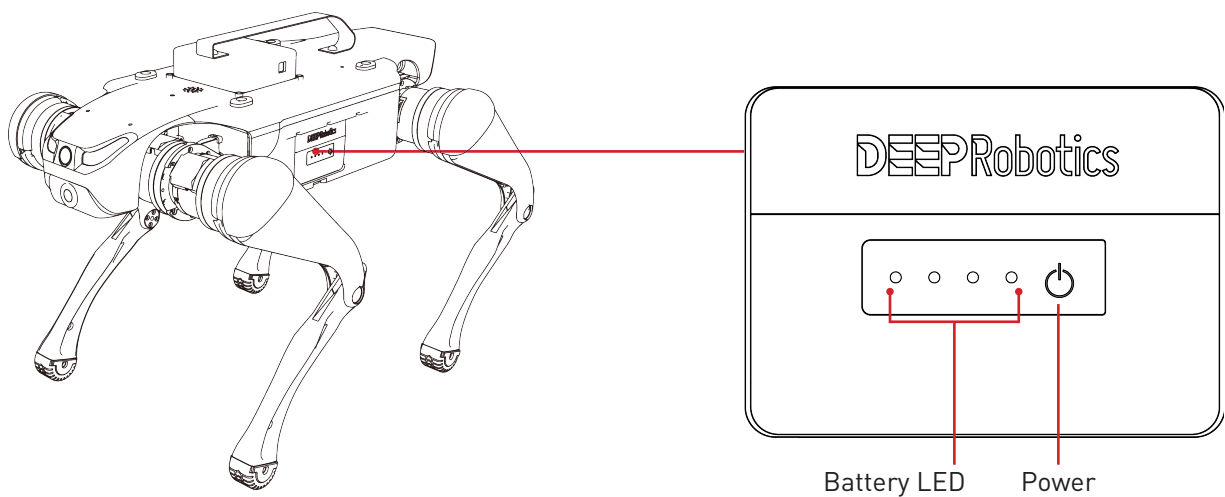

<span style="display: inline-block; width: 15px; height: 15px; border: 1px solid black; border-radius: 50%; margin-right: 5px;"></span> OFF		<span style="display: inline-block; width: 15px; height: 15px; background-color: gray; border-radius: 50%; margin-right: 5px;"></span> ON		<span style="display: inline-block; width: 15px; height: 15px; border: 1px solid black; border-radius: 50%; position: relative; margin-right: 5px;"> <span style="position: absolute; top: 50%; left: 50%; transform: translate(-50%, -50%); font-size: 8px;">+</span> </span> FLASHING		<span style="display: inline-block; width: 15px; height: 15px; background-color: gray; border-radius: 50%; position: relative; margin-right: 5px;"> <span style="position: absolute; top: 50%; left: 50%; transform: translate(-50%, -50%); font-size: 8px;">~</span> </span> MOVING	
Status				Meaning			
● ● ● ●		Four lights on		Power > 75%			
● ● ● ○		Three lights on		50% < Power < 75%			
● ● ○ ○		Two lights on		25% < Power < 50%			
● ○ ○ ○		One light on		20% < Power < 25%			
⦿ ⦿ ⦿ ⦿		Four flashing lights		5% < Power < 20%			
⦿ ○ ○ ○		One flashing for 30s and off		Power < 5%			
● ● ● ● ~~~~~		Moving light, light on in turn		Charging, lights show % charge			

### 2.2.3 LED Eyes

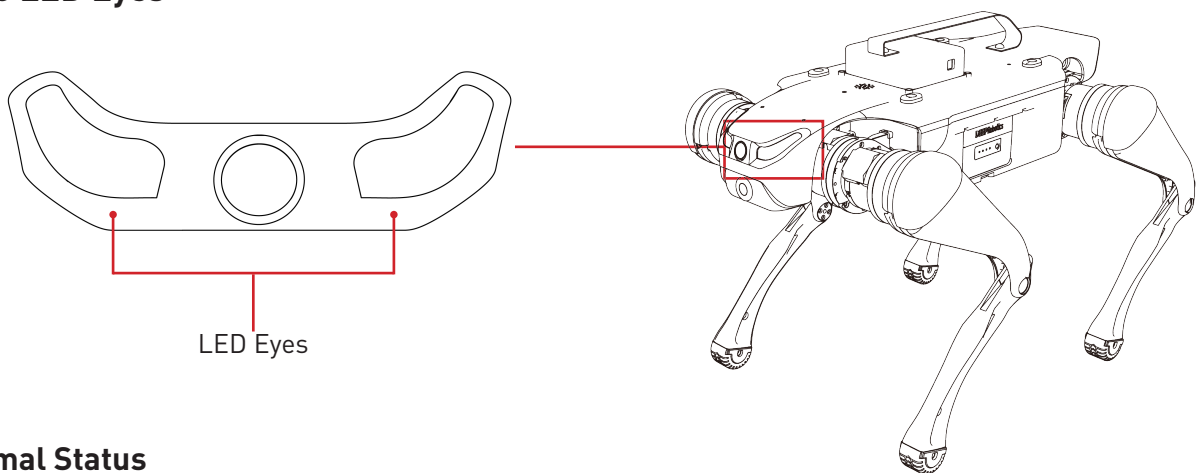

#### Normal Status

Light Status	Robot Status	Meaning
Blue moving lights	Starting	Starting up and self-checking
Blue breathing lights	Waiting for connection	Started, and waiting for the APP to connect
Blue lights on	Sit down	Connected, and the robot is sitting
White breathing lights	Moving	Standing, moving, or twisting
White lights flash twice	Change	Switching gait, action, status
White flashing lights	Fall Down & Get up	Falling down and getting up
Blue&purple moving lights	Performing / AI Mode	Performing an action in the action list / Entering AI mode

## Abnormal States

Light Status	Robot Status	Meaning
Yellow lights	Low Power (35%)	The power of robot is below 35%
Red lights on	Low Power (20%)	The power of robot is below 20%,need charging
Yellow & red lights flash in turn	Disconnection	Connection between robot and APP was broken
Red lights flash at medium speed	Overtemperature	Joints of the robot were too hot, need to wait until it cools down
Red lights flash at high speed	Overcurrent	Electric current of robot's joints was too high

## 2.3 "DEEP Robotics" APP

### 2.3.1 Home Page



Function	Description
① General	View APP Version, Change Language, etc.
② Album	View the screenshots of video streaming
③ Connect	Connecting to the robot WiFi
④ Control	Go to Control Page

## 2.3.2 Control Page

To access Control Page, click [④Control] button on Home Page.

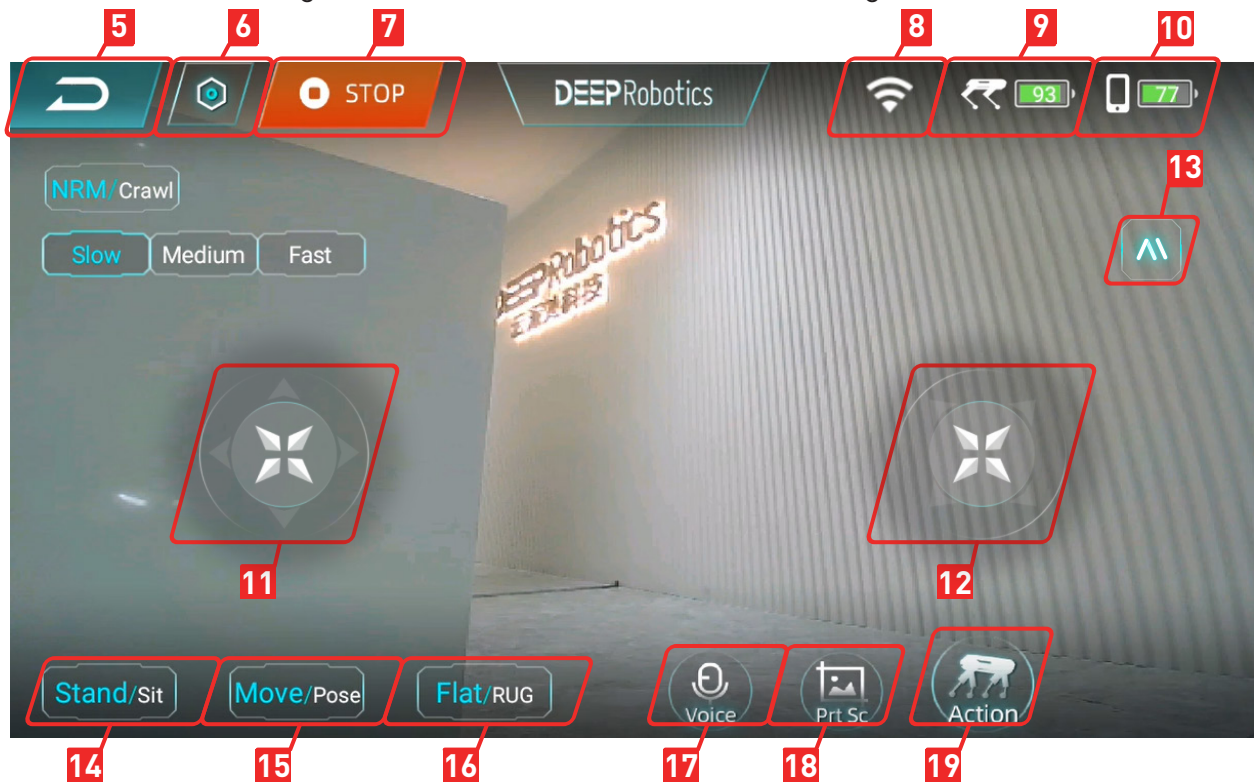

Function	Description
⑤ Return	Go back to Home Page
⑥ Settings	Motion Settings   Perception Settings   Other Settings (see 2.3.3 for details)
⑦ STOP	Make the robot down immediately, generally used when the robot's joints are uncontrollable or in an emergency
⑧ WiFi	Show robot WiFi signal strength
⑨ Robot Battery	Show the robot's battery percentage
⑩ Remote Control Battery	Show the remote controller's battery percentage
⑪ Left Joystick	Control the robot to translate in Move Mode and change its pitch and roll angle in Pose Mode
⑫ Right Joystick	Control the robot to rotate in Move Mode and change its height and yaw angle in Pose Mode
⑬ AI Function	Enable/disable the AI motion mode for the robot; displayed after activating [⑳ Lab Mode]
⑭ Stand/Sit	Switch Stand and Sit posture
⑮ Move/Pose	Choose a Motion Mode: Move Mode or Pose Mode

Function	Description
⑩ Flat/RUG	Choose a Motion Gait: Flat Gait or RUG Gait
⑪ Voice	Execute voice control function (see 3.8 for details)
⑫ Screenshot	Capture the current picture of the video stream
⑬ Action	Open the action list (see 2.3.5 for details)

### 2.3.3 Flat Gait

To access Flat gait, click [⑩Flat/RUG] button.

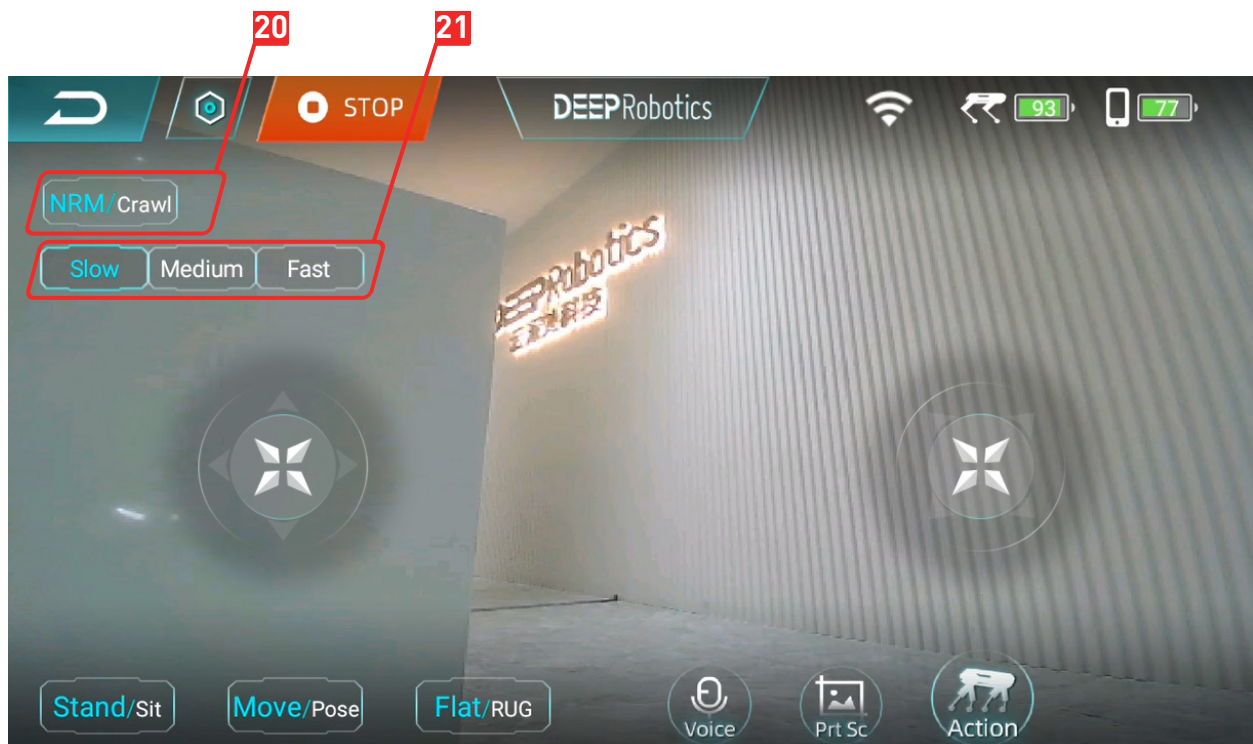

Gaits	Description
⑩ Body Height	Adjust the body height of the robot to NRM/Crawl: In NRM, the robot is in normal height and the velocity can be set to Slow, Medium or Fast; in Crawl, the robot lowers its body and moves at a default velocity.
⑪ Velocity	Set the velocity of the robot to Low, Medium, or Fast (Effective only when Body Height is in NRM)

### 2.3.4 RUG Gait

To access RUG gait, click [16 Flat/Rug] button.

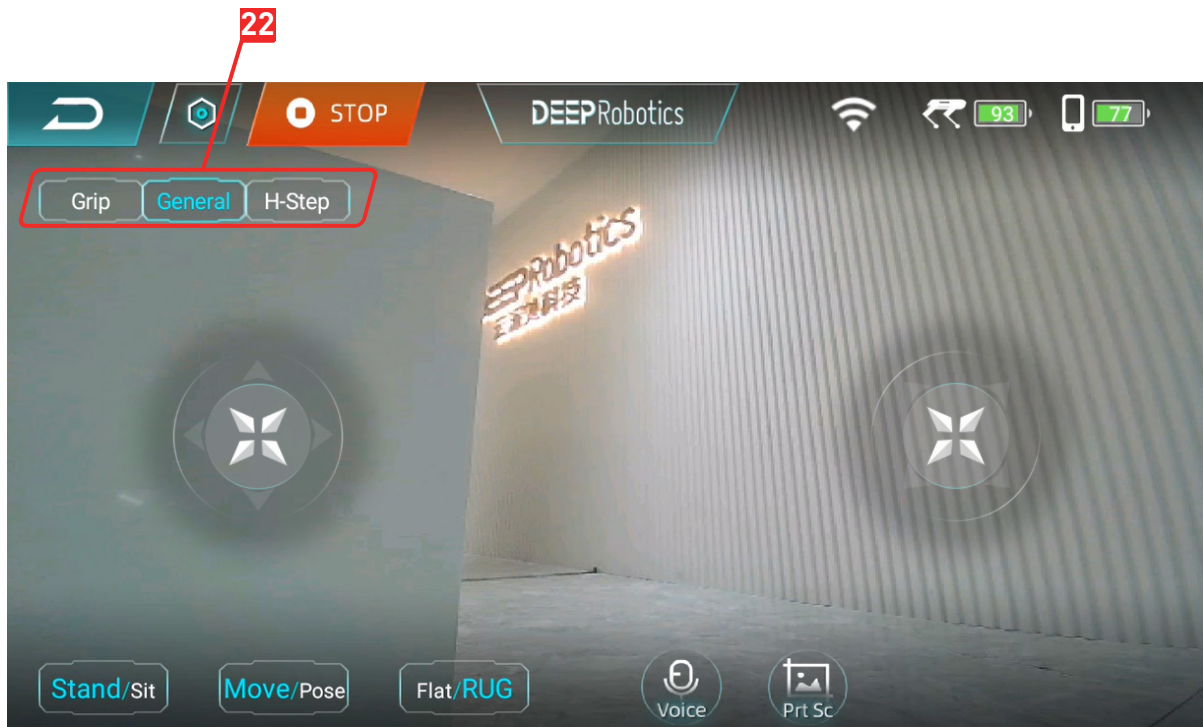

Gaits	Description
② RUG gait	Including three gaits for different rugged terrains: General, Grip, and H-Step
RUG	Applicable Terrain
General	Suitable for general stairs and slopes: steps' height $\leq 12\text{cm}$ ; slope $\leq 30^\circ$ (may be biased due to the slope material)
Grip	Suitable for steep slopes: slope $\leq 40^\circ$ (may be biased due to the slope material)
H-Step	Suitable for higher stairs: steps' height $\leq 15\text{cm}$

### 2.3.5 Action List

To access Action list, click [19 Action] button on Control Page.

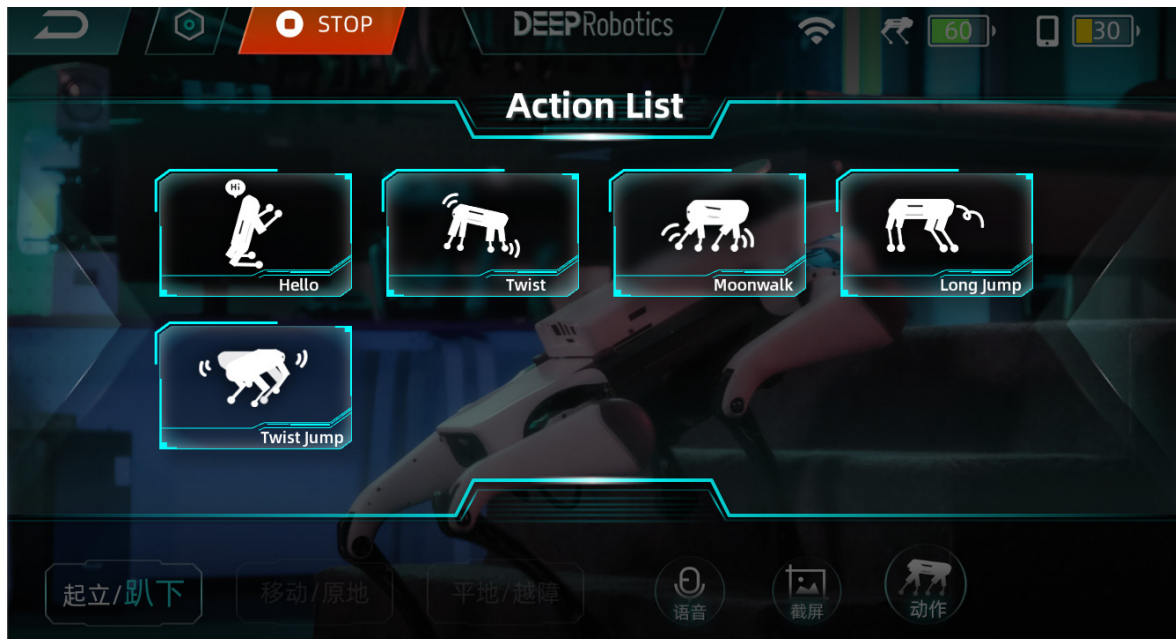

The robot can perform actions such as Hello, Twist, Moonwalk, Long Jump, Twist Jump.

### 2.3.6 Settings Page

To access Settings, click [6 Settings] button on Control Page.

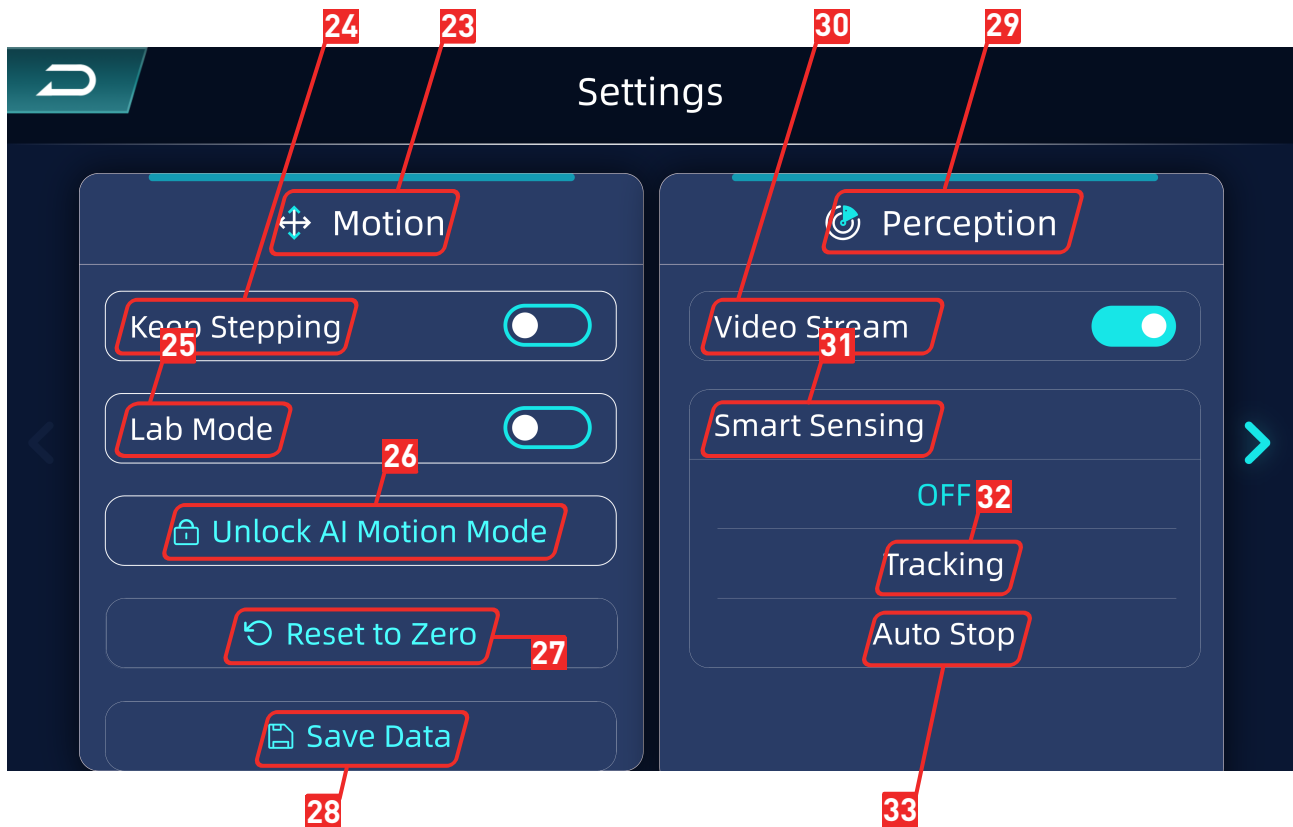

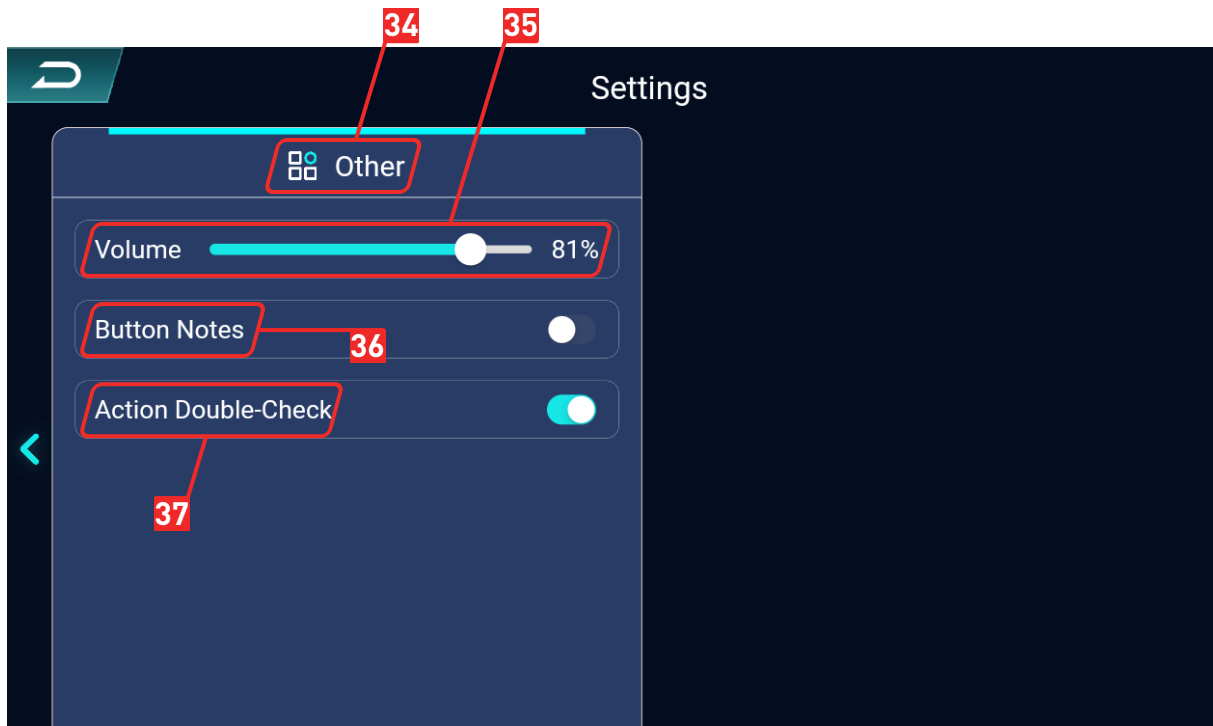

Function		Description	
②③ Motion	②④ Keep Stepping	Make the robot keep stepping	
	②⑤ Lab Mode	Allow users to try out experimental features	
	②⑥ Unlock AI Motion Mode	Press to unlock the robot's AI motion mode	
	②⑦ Reset to Zero	Initialize the joint motor when it loses its position (only available when the robot is sitting)	
	②⑧ Save Data	Save the fault information to the motion host for troubleshooting	
②⑨ Perception	③⑩ Video Stream	Show the live stream of robot camera	
	③① Smart Sensing	③② Tracking	The robot can autonomously follow the selected person in the control page (see 3.9.2 for details)
		③③ Auto Stop	Automatically stop when encountering obstacles (see 3.9.1 for details)
③④ Other	③⑤ Speaker	Turn on and off robot speaker	
	③⑥ Button Notes	Display the physical button name in the upper-right corner of the virtual button	
	③⑦ Action Double-Check	A safety tip will appear before performing Long Jump, Backflip or Carpet Backflip	

### 2.3.7 AI Motion Mode

To enter AI motion mode, click [13 AI Motion Mode] button on Control Page.

	<p>This feature is available only after unlocking the AI motion mode (see Section 2.4 for details).</p>
---	---

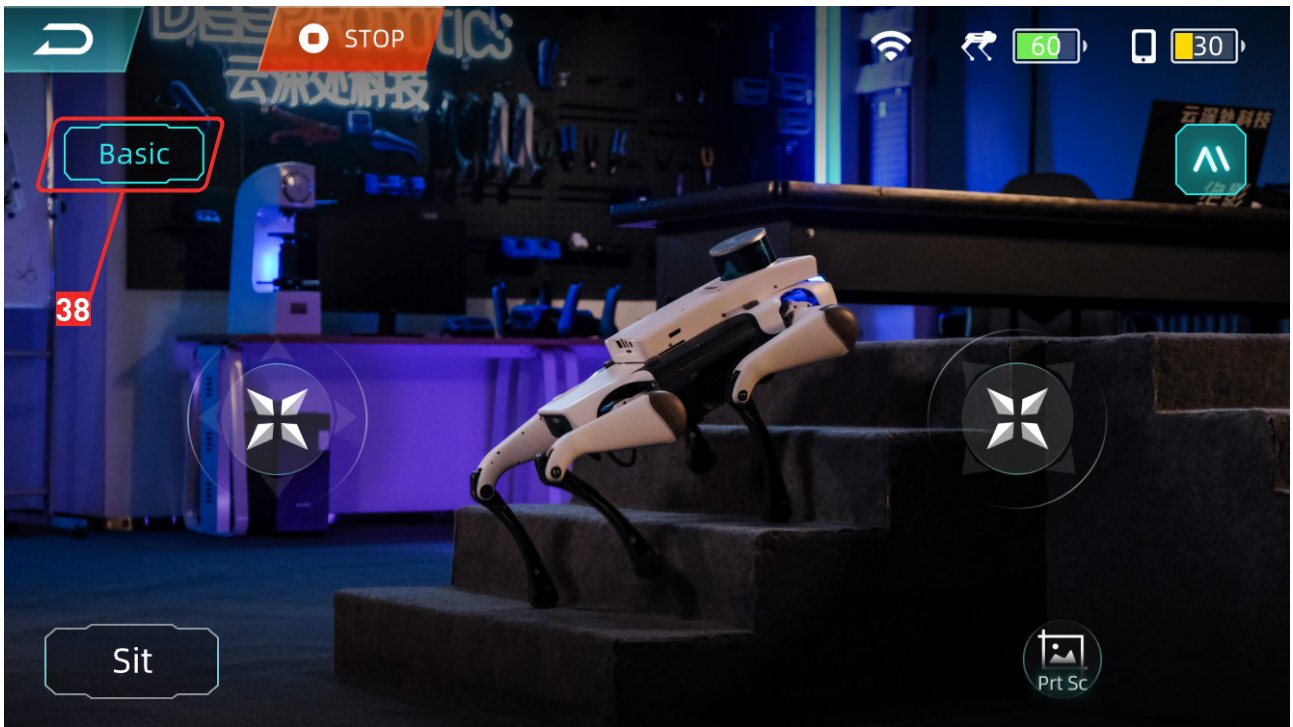

Gaits	Description
⑬ AI Gait	Including Base AI gait

AI Gaits	Applicable Terrain
Base	Maximum forward speed: 0.8 m/s. Suitable for standard paved and unpaved surfaces. Supports traction control when no axis command is issued. Suitable for general stairs and slopes: steps' height ≤18cm; slope ≤ 30° (may be biased due to the slope material).

※ Data above are measured under ideal conditions, and the actual results may be biased.

## 2.4 Unlock AI Motion Mode

Instructions for First-Time Unlocking of the AI Motion Mode Function:

- Obtain the MAC address of the device to be unlocked: After connecting the APP to the quadruped robot, go to the home page and tap [**① General**] - [**About Device**] to view the robot's MAC address.
- Obtain the activation key: Provide the robot's MAC address to after-sales support to receive the activation key for unlocking the AI motion mode function.
- Enter the key and unlock the function: On the Control Page, tap the [**⑥ Settings**] button, then select [**⑳ Motion**] - [**㉔ Unlock AI Motion Mode**]. Enter the activation key obtained in the previous step in the pop-up window to unlock the AI motion function.

After successful activation, enable the [**㉕ Lab Mode**] function. The [**⑬ AI Function**] toggle will appear on the right side of the Control Page. Click it to enter the AI motion mode.

## 3 Operation

### 3.1 Preparation

#### 3.1.1 Environment

	<ul style="list-style-type: none"> <li>• Please ensure that operators and non-operators present have read the manual carefully and understand the basic operating instructions and safety precautions.</li> <li>• Before start the robot, ensure that all people or objects present are more than 1 meter away from the robot to avoid collisions.</li> <li>• Please use the robot in an environment of 0°C ~40°C.</li> </ul>
---	---

#### 3.1.2 Carrying

Hold the back handle of the robot and lift it out of the transport box onto a flat road surface.

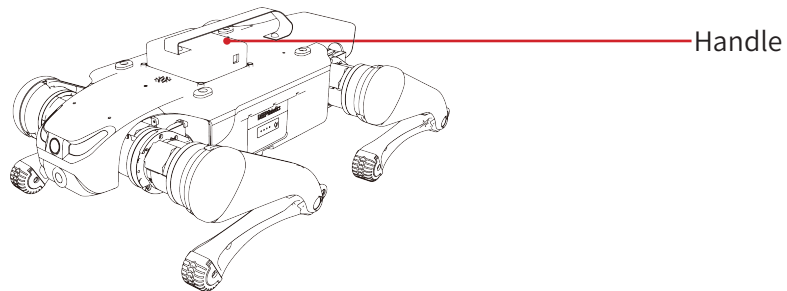

	<ul style="list-style-type: none"> <li>• Please carry the robot gently. Please do not release the robot handle when the robot is lifted, to prevent it from falling, which may cause the robot to lose control or even be damaged.</li> <li>• Please avoid joints to prevent pinching or even scratching.</li> <li>• The handle requires self-installation. Please contact after-sales for assistance</li> </ul>
---	--

#### 3.1.3 Checking

	<ul style="list-style-type: none"> <li>• Press the power button once to check the battery. It is suggested to start the robot when the battery power is at least 75%.</li> <li>• Make sure the remote controller is fully charged.</li> <li>• Make sure there is no visible damage to the exterior of the robot.</li> <li>• Check if Emergency STOP Controller has power and STOP Button is released.</li> </ul>
---	--

	<p>If the robot parts are aging or damaged, please do not start the robot and contact the after-sales staff in time.</p>
---	--

### 3.2 Charging

Jueying Lite3 is powered by a ternary lithium battery that is pluggable. User can insert the battery into the charging base for charging.

1. First lift the robot up slightly on the left side and place it firmly, and then press the button at the bottom of the battery bin and the battery will pop out, after which the battery can be removed from the battery bin.

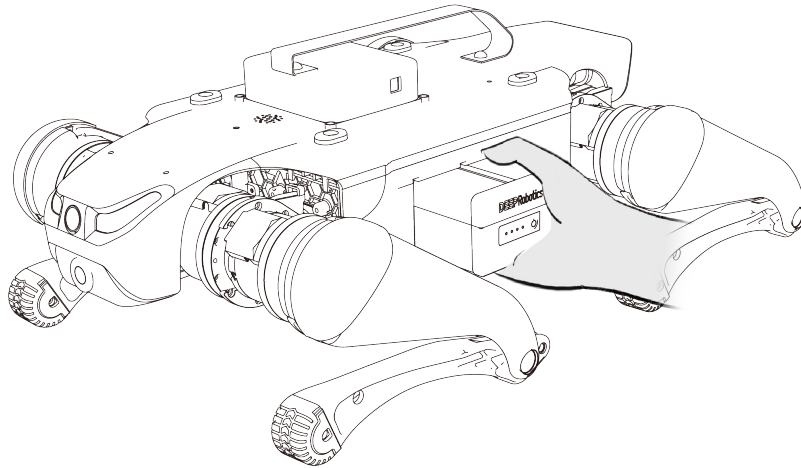

2. Insert the battery into the charging base, connect the charging base to the charger, and then connect the charger to the mains (100V~240V) for charging, and the charger light will light up green.

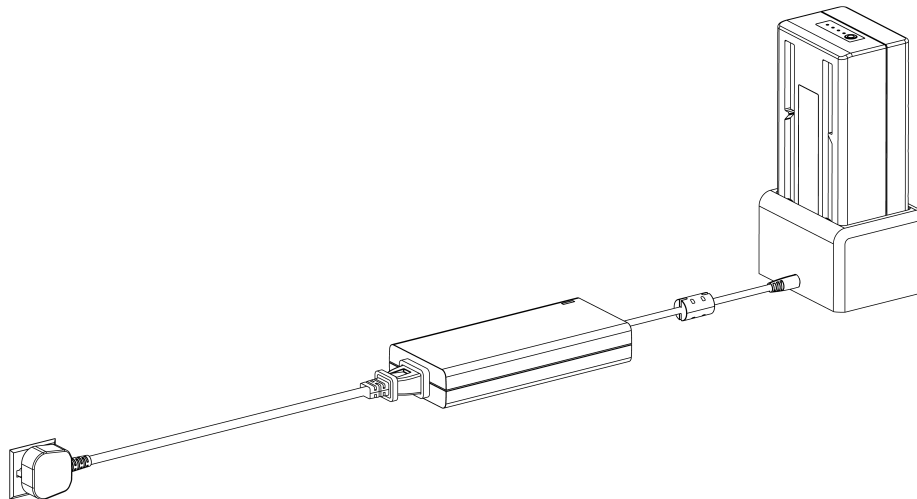

3. When charging, the battery LED lights are all in a moving state, and the number of lights on corresponds to the power already charged.

4. After finishing charging, the four LED lights on the battery will turn off.



- It is recommended charge in an environment of 5°C ~30°C.
- During charging, please always pay attention to the battery and charger to prevent accidents, and disconnect the charging power in time after charging is completed.

### 3.3 Start

Press the power button briefly and then press and hold until the LED lights flash once, the robot starts up, and the power light shows the current battery level. Then power on Emergency STOP Controller.

### 3.4 Connection

	<p>During the startup of the built-in wireless router in the robot, LED Eyes lights up with blue moving lights. Connect the remote controller to the robot after LED Eyes turns into blue breathing lights.</p>
---	---

1. Scan the QR code to download and install "DEEP Robotics" APP. "DEEP Robotics" APP supports Android 6.0 or later, and does not yet support iOS.



2. Open "DEEP Robotics" APP on remote controller or your phone.



3. Check the label on the Warranty Card for WiFi information and click [③Connect] button to connect. After the connection is completed, you can click the [④Control] button to enter the control page and control the robot.

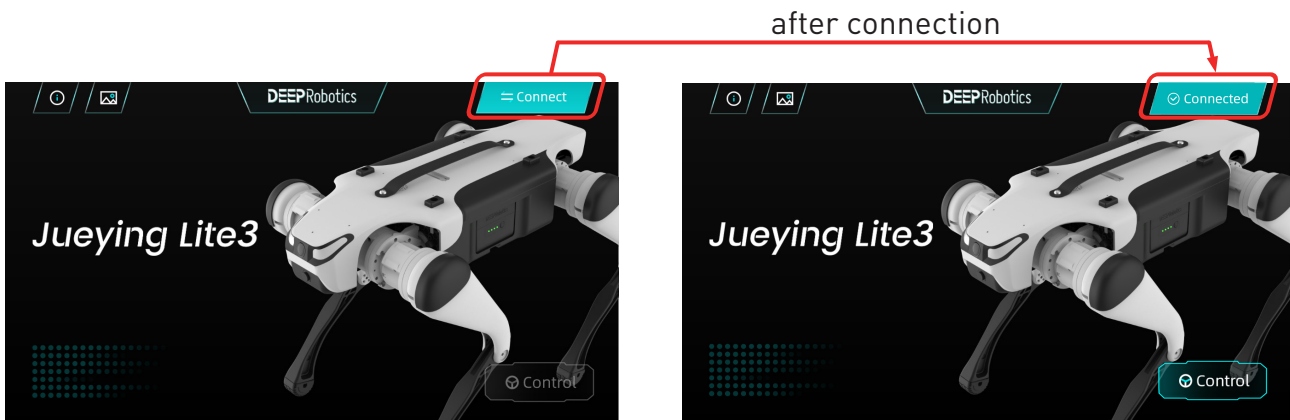

### 3.5 Reset to Zero

After connected, position the robot to Ready Posture and then enter Control Page and click the **[14Stand]** button to initializing the robot which takes about 10 seconds. The robot will reset to zero and then automatically stand up.

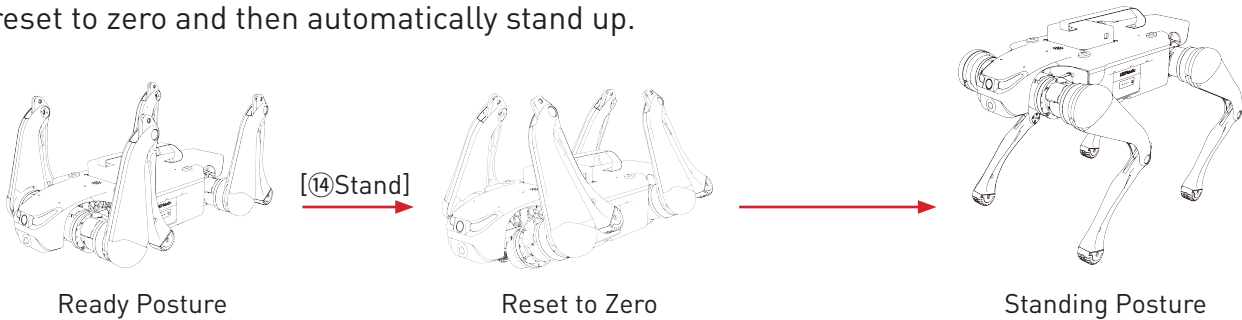

### 3.6 Motion Control

After standing up, you can select gait or terrain options in Move Mode, and push the joysticks to make the robot move.

When the robot moves on flat terrain with Flat gait, users can choose an appropriate body height and velocity according to needs.

When encountering lower steps, stairs, or gentle slopes or grasslands, users can choose the General gait of RUG; when encountering steep slopes, users can choose the Grip gait of RUG; when encountering higher steps, users can choose the H-Step gait of RUG.

After standing up, in Pose Mode, the joysticks can be pushed to make the robot twist.



When the robot passes through stairs or slopes, do not stand on the stairs, platforms, or slopes below the robot to avoid potential personal injury when the robot falls.

### 3.7 Action Options

When the robot is standing or lying still, user can click the **[19Action]** button to open the action list and select an action.



- To perform Long Jump, make sure that there are no obstacles within 2m in front of the robot.
- Please avoid using the robot continuously and intensively, otherwise it may cause overheating or damage.

### 3.8 Voice Command

Click the [17Voice] button at the bottom of the Control Page and say the corresponding command, and the robot will execute the corresponding action.

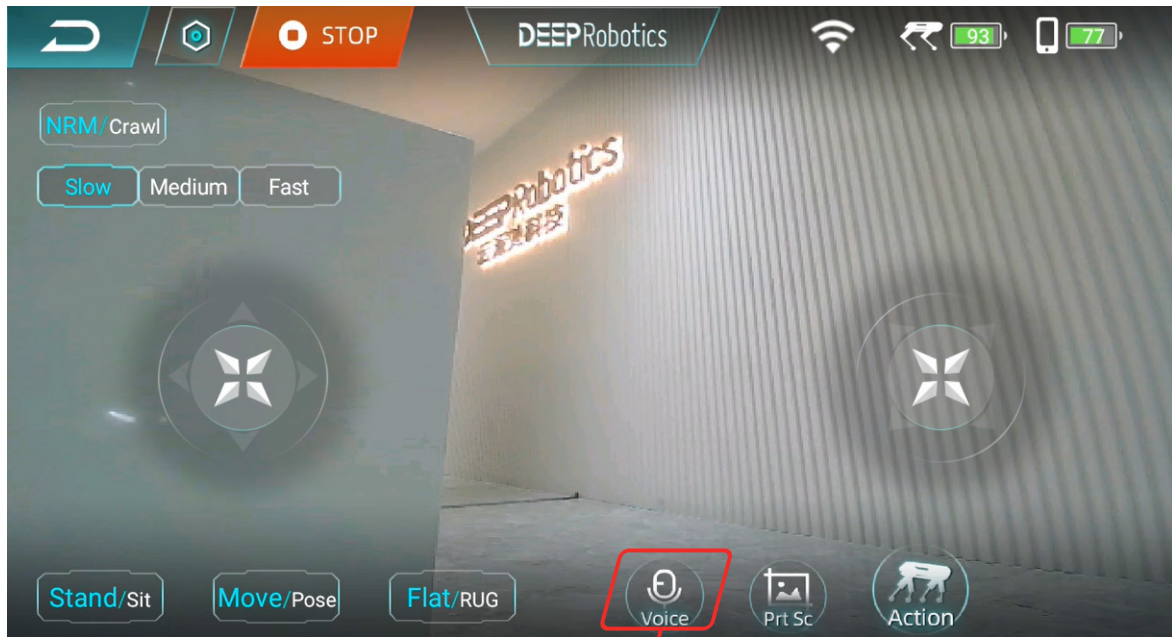

17

Command (EN)	Command (ZH)	Action
stand up	站起来	Stand up
get down	趴下	Get down
go forward	往前走	Walk forward for 5 seconds
go backward	往后走	Walk backward for 5 seconds
go left	往左走	Walk to the left for 5 seconds
go right	往右走	Walk to the right for 5 seconds
stop	停止	Stop walking
look up	往上看	Raise the head
look down	往下看	Bow the head
look left	往左看	Turn head to the left
look right	往右看	Turn head to the right
turn left	往左转	Turn 90° to the left and stop
turn right	往右转	Turn 90° to the right and stop
turn around	往后转	Turn backwards 180° and stop
say hello	恭喜发财	Greet

## 3.9 Smart Sensing

### 3.9.1 Tracking

Click the [⑥Settings] button to enter the Settings Page, and select the [③②Tracking] option in [③①Smart Sensing] to enable the visual tracking function. After returning to the Control Page, when the robot detects a person, it will frame the person with a gray box on the screen, click the gray box of the object that needs to follow, and when the gray box turns green, the object will be selected successfully. The robot will autonomously follow the object in the green box when it is upright.

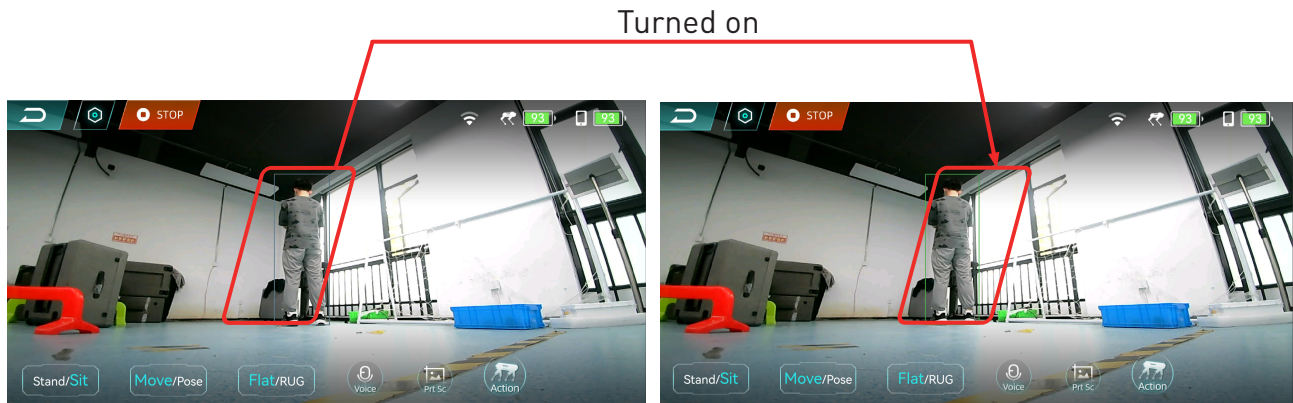

- When the Tracking function is enabled and there is a follow target framed in a green box on the Control Page, using the joystick to control the robot will cancel the selected target.
- Robot can not detect obstacles when tracking. Please ensure there are no obstacles in the direction of robot to avoid collisions.
- Please press the soft emergency stop in case of an emergency.

### 3.9.2 Auto Stop

Click the [⑥Settings] button to enter the Settings Page and select the [③③Auto Stop] option in [③①Smart Sensing] to enable the auto stop function. Return to the Control Page, and manually push the joysticks to make the robot move. The robot will be able to detect obstacles forward and backward and slow down.

### 3.10 Payload

Users can screw devices into the thread holes on the back of robot (unit: mm).

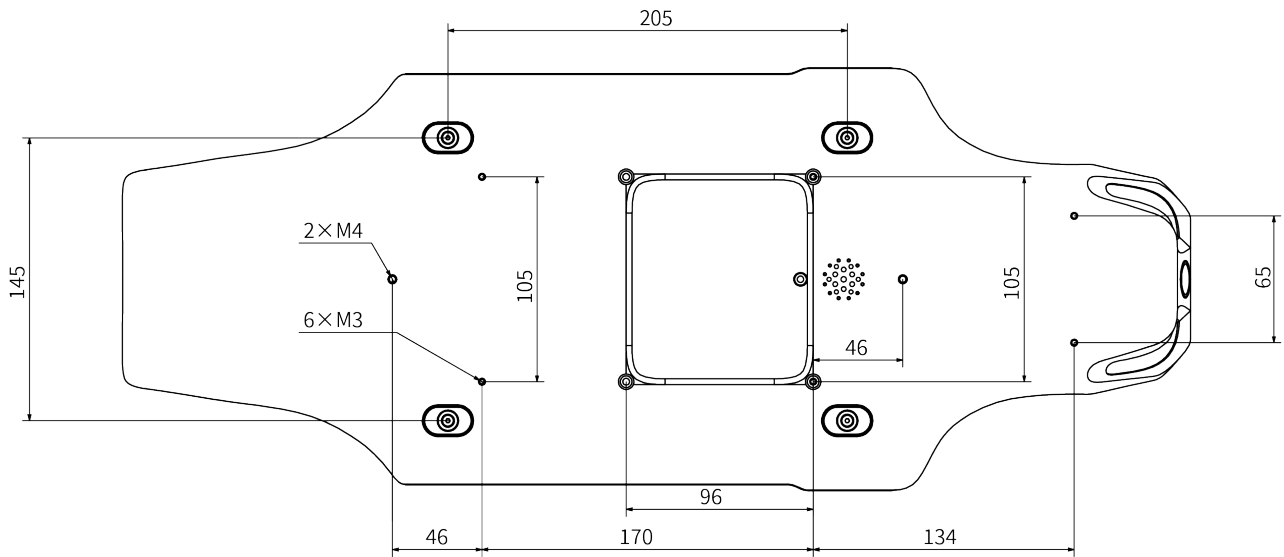

	<p>When the weight of devices reaches or exceeds 4.5 kilograms, robot's motion performance may be affected. Please consult with after-sales personnel before adding overweight devices.</p>
--	---

### 3.11 Emergency Operation

#### 3.11.1 Emergency STOP

When the robot swings its legs, shakes violently or other abnormal phenomena occurs in use, push STOP Button on Emergency STOP Controller into stop to let the robot into a protected state. The robot will automatically get down, and shut down. After troubleshooting, release STOP Button by twisting it.

#### 3.11.2 Fall Down & Get up

When the robot falls on its back accidentally, you can choose to let the robot turn left or turn right based on the surrounding obstacles: If there is an obstacle on the left side of the robot, choose right. If there is an obstacle on the right side of the robot, choose left.



### 3.11.3 Overtemperature

When the robot runs for a long time and cause the motor or actuator to overheat, it will automatically turn on overtemperature protection: stop moving and sit down in place. Please wait until it cools down and then press [**14Stand/Sit**] to continue.

### 3.11.4 Low Battery

When the robot's power is below 35%, users should change or charge the battery as soon as possible. When the robot's power is below 20%, low power protection will be triggered and the robot will not respond to motion commands. Please power off the robot and replace the battery, referring to "3.2 Charging" for specific instructions on replacing batteries.

### 3.11.5 Other

- If the robot is out of control with AI options, press the [**7STOP**] in time.
- If you encounter a fire, do not use water to extinguish it. Please use one of the following types of fire extinguishers nearby: foam, dry powder or carbon dioxide.
- If [**7STOP**] fails or the robot has smoke or water in it or other unexpected situations occur, please try to cut off the robot power and remove the battery at first. And wait until it's safe to troubleshoot the problem. Then feedback the situation to DEEP Robotics, and we will offer help. Please pay attention to safety in use.

## 3.12 Power Off

	<p>Make sure that the robot is down before performing the following operations.</p>
---	---

Press the power button briefly and then press and hold until the LED lights flash once. Then the robot LED Eyes and the battery LED lights turn off, indicating the shutdown is completed.

## 4 Precautions

### 4.1 Work Environment

	<ul style="list-style-type: none"> <li>• Do not operate the robot in environments with strong electromagnetic interference such as high-voltage cable, high-voltage transmission stations, base stations and television broadcasting towers, etc.</li> <li>• Please do not operate the robot in environments with strong WiFi signal interference. Be sure to turn off all other WiFi signal source, and then use DEEP Robotics APP to operate the robot.</li> <li>• Do not operate the robot in bad weather with fog, snow, rain, lightning, sandstorms, windstorms, tornadoes, etc.</li> <li>• Keep the robot in sight and keep it at least 1 meter away from people, water, open flames, etc. at all times.</li> <li>• When using the robot on smooth surfaces such as ice, glass and tiles, avoid violent movements and use Grip gait to prevent the robot from slipping and falling.</li> <li>• Do not run the robot on the edge of a high place to prevent it from falling from a height and causing damage.</li> </ul>
---	---

### 4.2 Battery

	<ul style="list-style-type: none"> <li>• When water is touched inside the battery, a decomposition reaction may occur, which may cause the battery to self-ignite or even explode. It is strictly forbidden to expose batteries to any liquid, never immerse them in water or get wet, and never use them in rain or wet environment. If the battery accidentally falls into water, immediately place the battery in a safe open area and keep it away from the battery until it is completely dry. Drying batteries should not be reused.</li> <li>• It is strictly forbidden to use drum bags, leaks, damaged batteries and charge them. Rechargeable lithium batteries should not be used when they appear odor, distortion, discoloration or any other abnormal phenomenon. In case of abnormal battery condition, please contact after-sale for further treatment.</li> <li>• Disassembly of batteries without authorization is prohibited. Once disassembled, no warranty is granted. Deep Robotics is not responsible for battery accidents caused by the removal of batteries.</li> <li>• Recharge and discharge every 3 months to maintain battery activity.</li> <li>• Please refer to the battery instructions for details.</li> </ul>
---	---

### 4.3 Other Precautions



- When handling the robot, pay attention to the anti-pinch label on the robot and never put your hands into the position where the anti-pinch label is attached!
- Pay attention to the sealing label on the robot. It is strictly forbidden to disassemble the robot privately. Once disassembled, the warranty will be invalid!
- The device is restricted to indoor use only when operating in the 5150 to 5250 MHz frequency range.

### 4.4 Disposal

- The disposal of waste robots and parts is to be carried out in accordance with the corresponding national laws and regulations on the recycling of waste electrical and electronic products.
- In particular, the use or disposal of lithium batteries contained in robots is subject to national laws and regulations governing the disposal of batteries.

## 5 FAQs

**Q1: Is it normal for a robot to stop moving on its own?**

A: The motor or driver may be overtemperature. Please wait 10 minutes and try again. If you still can't control the robot to move, please check if the power is sufficient.

**Q2: What if the robot falls down due to the loss of control of one of its legs?**

A: First click [⑦STOP] to make it down. Then restart the robot. If it does not return to normal after restarting, please contact after-sales staff.

**Q3: What if the video stream gets stuck after the robot falls?**

A: Restart the robot. If the video stream is still black, please contact after-sales staff.

**Q4: What if encountering a problem that cannot be solved even after consulting this manual?**

A: Click [⑳ Save Data] in Motion Settings and contact the after-sales staff promptly.

## 6 Transport & Storage

### 6.1 Transportation

The transport case is 633mm×462mm×329mm.



Before shipping the robot with transport case, remove the batteries from the robot. And when shipping, make sure the front of the transport case (with DEEP Robotics logo) is facing up.

### 6.2 Storage

- Jueying Lite3 requires a clean and dry storage environment of 0°C ~40°C .
- Robot power must be off, and if the robot will not be used for a long time, remove the batteries from the robot.
- Do not allow water or other liquids to drench the robot.
- It is strictly forbidden to place other objects within the joint rotation range.
- It is recommended to store Jueying Lite3 in the transport case specifically designed for it to protect it from shock and vibration.
- Jueying Lite3 must be placed in the transport case with its back facing up.
- For the precautions for battery storage, refer to the battery instructions.

## 7 Service & Warranty

### 7.1 After-Sales Service

Provide free training of using and operating robot, online technical support and after-sales service to users.

### 7.2 Warranty Policy

The warranty period for the major components of Jueying Lite3 is as below.

Component Name	Warranty Period
Joint Module and Leg Components (Unlocking AI Function)	Three months
Joint Module, Leg Components, Replaceable Battery	Six months
Wide Angle Camera, Ultrasonic Radars, Control System, Other Electronic Components	One year

**Tip: Shell, foot and other fragile parts, and transport case and other accessories are not covered by warranty. If necessary, please consult after-sales support; the default warranty period for the robot's joint modules and leg components is 6 months and after unlocking the AI motion mode function, the warranty period for the joint modules and leg components will be reduced to 3 months.**

The warranty period starts from the date of receipt. Products or parts that meet the warranty period and the contents of the warranty will receive free after-sales service. If the product you purchased is beyond the warranty period, you can also get help from us by purchasing a separate service.

### 7.3 Warranty Coverage

Depending on the specific situation, we will repair or replace parts accordingly for the product you purchased. However, the following cases will not be covered by the free warranty, but you can still choose to have paid after-sales service, for which please consult the after-sales support for details.

- Damage caused by man-made problems but not by quality problems of the product itself occurs.
- Private modification, disassembly or opening of the shell occurs.
- Damage caused by incorrect installation, use and operation in accordance with the manual.
- Damage caused by use in excess of safe load range.
- Damage caused by self-installation of third party products.
- Failure or damage due to force majeure factors such as typhoon, earthquake, fire, lightning strike, abnormal voltage, etc.

## 7.4 Repair Instructions

- Before getting after-sales service, please make sure to backup all data and delete important data to prevent data loss or leakage. DEEP Robotics is not responsible for the loss or leakage of any data contained in the product.
- When you obtain after-sales service from DEEP Robotics, you authorize DEEP Robotics to make any modification, delete data or restore factory settings for the purpose of after-sales service.
- Before sending it for repair, please contact after-sales support, DEEP Robotics will try to diagnose and solve your problem remotely.
- If the above methods cannot solve your problem, you can send it back to the robot for repair after verifying with after-sales support. You need to pay for the postage first when you send the product to DEEP Robotics. After DEEP Robotics receives the product in need of maintenance, the product will be tested to determine the problem and responsibility.
- If the problem is caused by defects in quality of the product itself, DEEP Robotics will be responsible for the testing fee, material fee, labor fee and the postage for sending back.
- If the product does not meet the conditions of free repair, you can choose to pay for repair, and the corresponding testing fee, material fee, labor fee and the postage for sending back will be paid by you. You can also choose not to repair and to send back the product, the corresponding postage and insurance fee will be paid by you.
- Considering environmental protection and safety, please do not send back seriously damaged batteries. If you have sent back, DEEP Robotics will scrap such batteries and will not return them back.
- If you provide an incorrect delivery address which results in non-delivery or rejection by the recipient, the adverse consequences and losses shall be afforded by you.
- To ensure your rights and interests, when you sign for the after-sale products sent by DEEP Robotics, please check carefully whether the products are intact. If there is any abnormality, please immediately take video or photos on the spot and contact DEEP Robotics to get the solution. If there are unresolved after-sale problems, please also contact DEEP Robotics immediately, otherwise it is regarded as the end of this after-sale service without dispute.

※The final interpretation of these after-sales terms and conditions belongs to DEEP Robotics.

※Please contact us if you have any questions before obtaining after-sales service.

※These after-sales terms and conditions are only used in mainland China, and the after-sales policies of other countries or regions are subject to local laws.



# DEEPRobotics

Hangzhou Yunshenchu Technology Co.,Ltd.

ADD: Building 3, Zijin Dream Plaza, No.36 Xinran Street, Sandun Town,  
Xihu District, Hangzhou, Zhejiang, China

TEL: +86 400-0559-095

WEB: [www.deeprobotics.cn](http://www.deeprobotics.cn)

