

Power

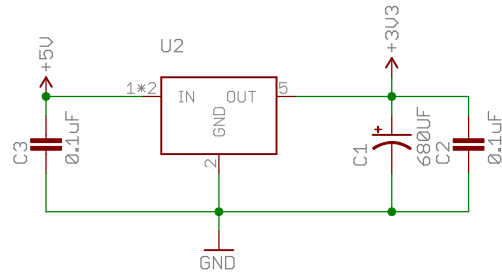

Indicator

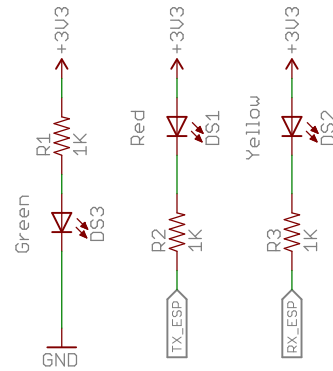

Arduino Shield

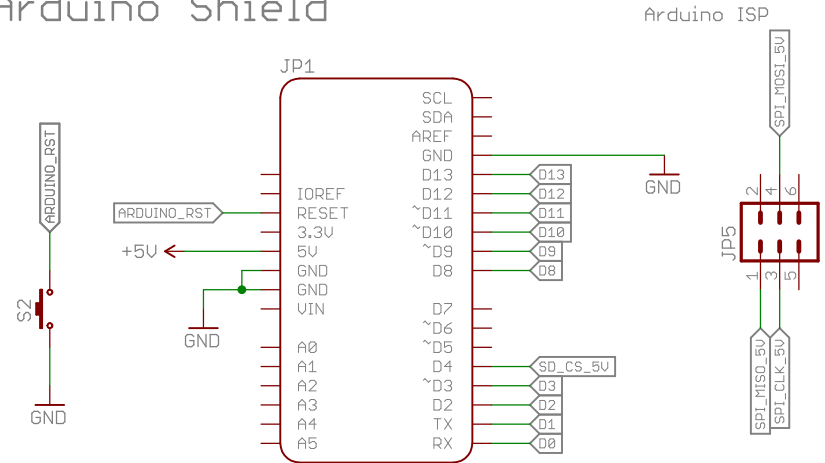

UART

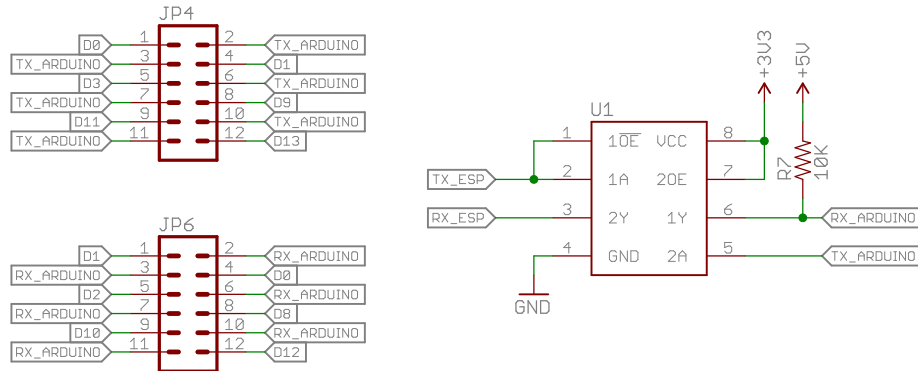

MicroSD

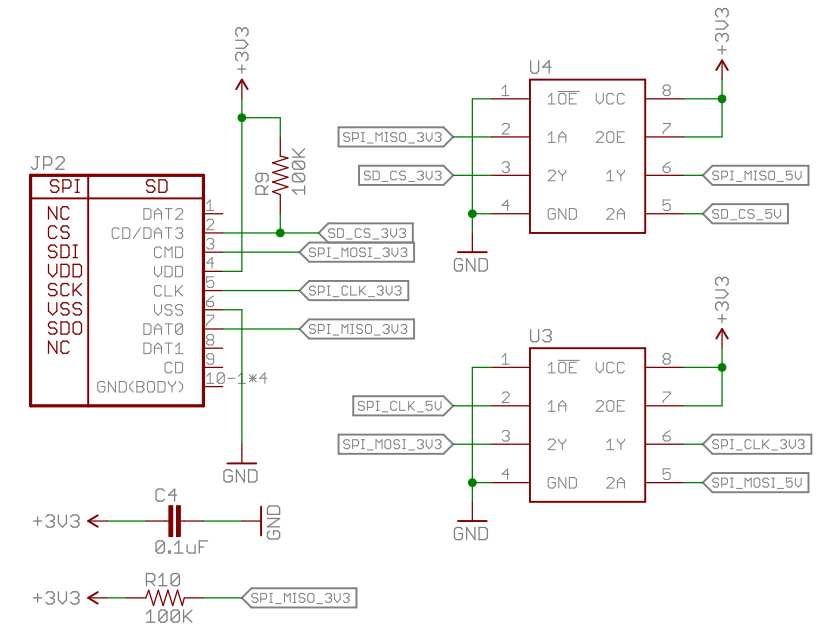

ESP8266 Module

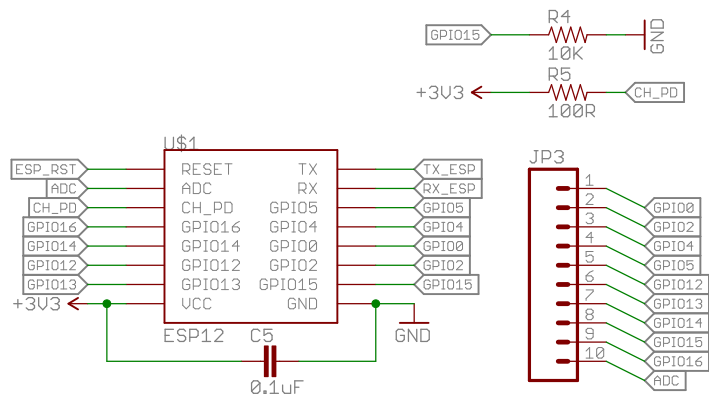

ESP8266 Flash

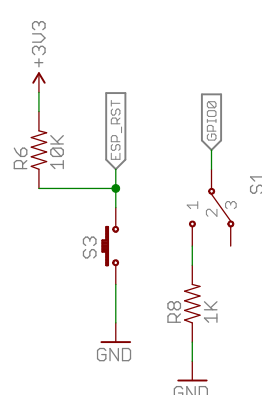

Name:	
Product Code: SHIELD-ESP-WIFI	REV:
Date: 11/4/2015 10:17 AM	Sheet: 1/1