

Gen 3

Lab Grade Gold ORP Probe

Reads	ORP
Range	-2000mV – 2000mV
Accuracy	+/- 1mV
Response time	95% in 1s
Temperature range °C	1 – 99 °C
Sensing element	Gold
Max pressure	100 PSI
Max depth	70m (230 ft)
Connector	Male SMA / Male BNC (Optional)
Cable length	1 meter
Internal temperature sensor	No
Time before recalibration	~1 Year
Life expectancy	~2 Years

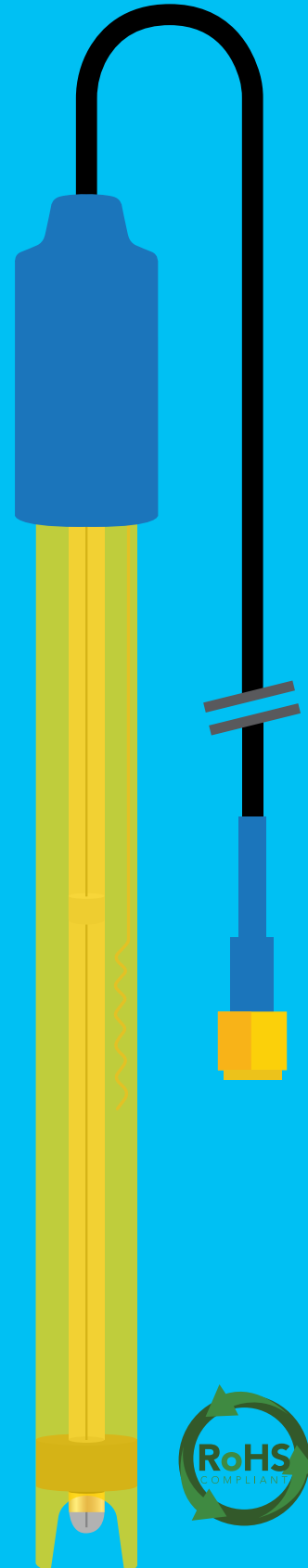

Operating principle

ORP stands for **oxidation/reduction potential**. Oxidation is the loss of electrons and reduction is the gain of electrons. The output of the probe is represented in millivolts and can be positive or negative.

Just like a pH probe measures hydrogen ion activity in a liquid; an ORP probe measures electron activity in a liquid. The ORP readings represents how strongly electrons are transferred to or from substances in a liquid. Keeping in mind that the readings do not indicate the amount of electrons available for transfer.

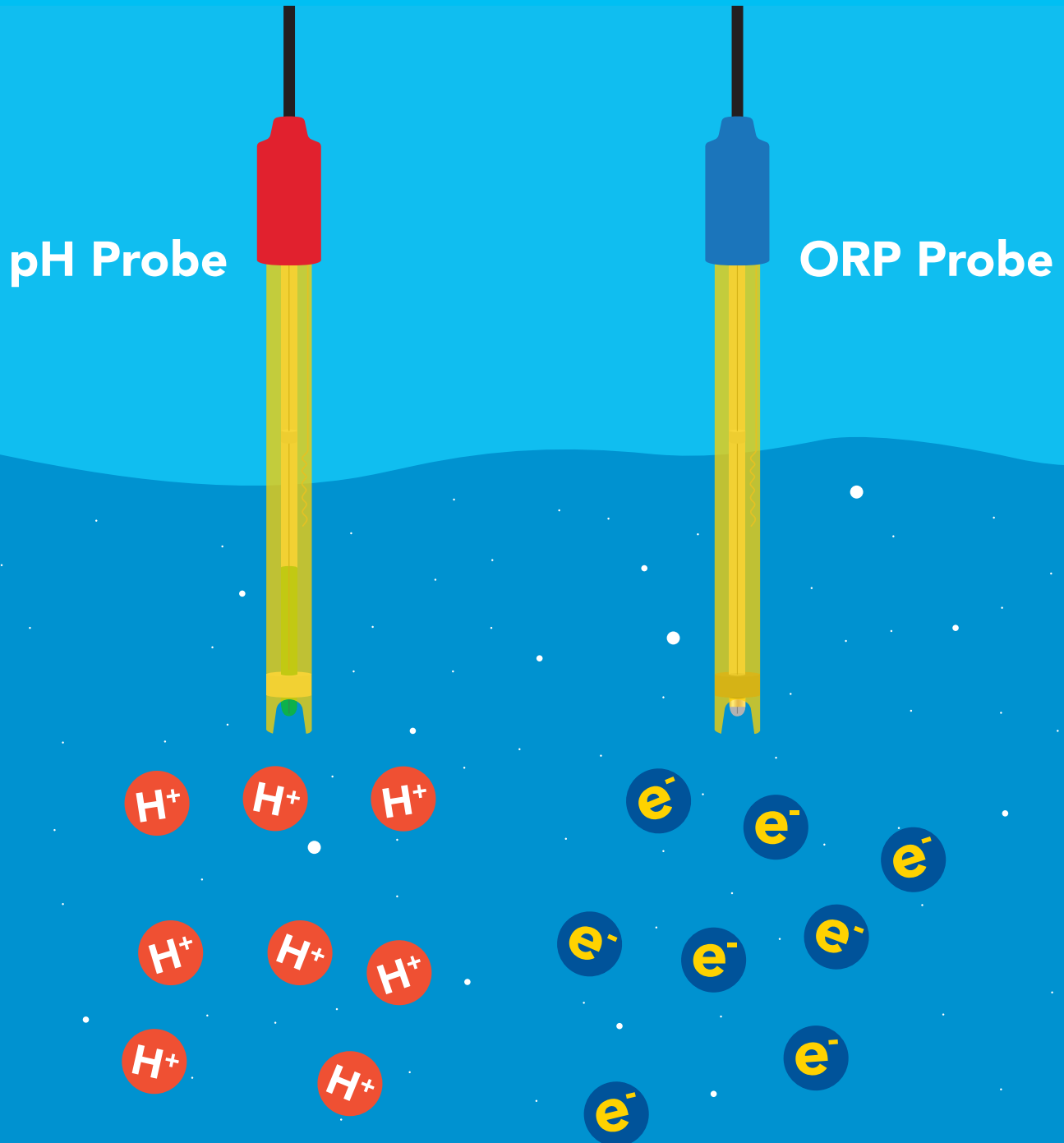

When reading the ORP of a liquid that has very few electrons available for transfer ORP readings can appear to be inconsistent.

The water is unreactive and has only trace amounts of electron movement. *These readings are equivalent to the readings you see with an unconnected multimeter.*

-234.6
Reading A

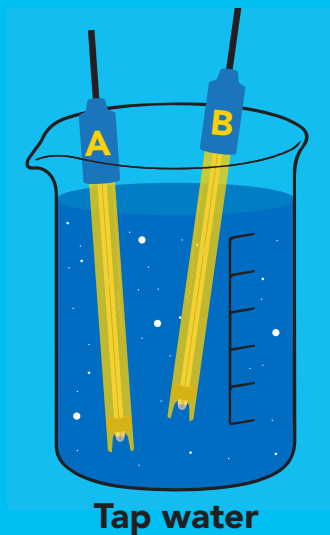

24.2
Reading B

606.9
Reading A

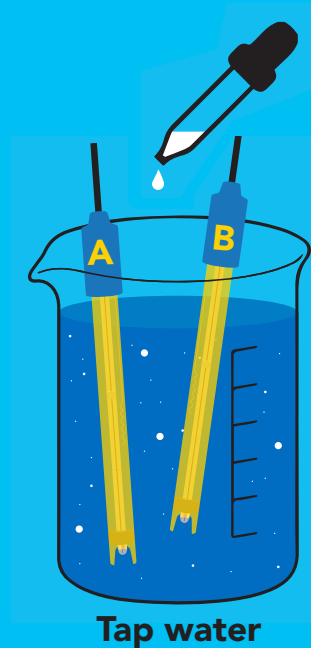

605.3
Reading B

**Add just a drop of bleach
(which is an oxidizing agent)**

This ORP probe has a gold catalyst tip that is connected to a silver wire, surrounded by silver chloride. That silver wire is then connected to a KCL reference solution. Because gold is an unreactive metal it can "silently observe" the electron activity of the liquid without becoming a part of whatever reaction is occurring in the liquid.

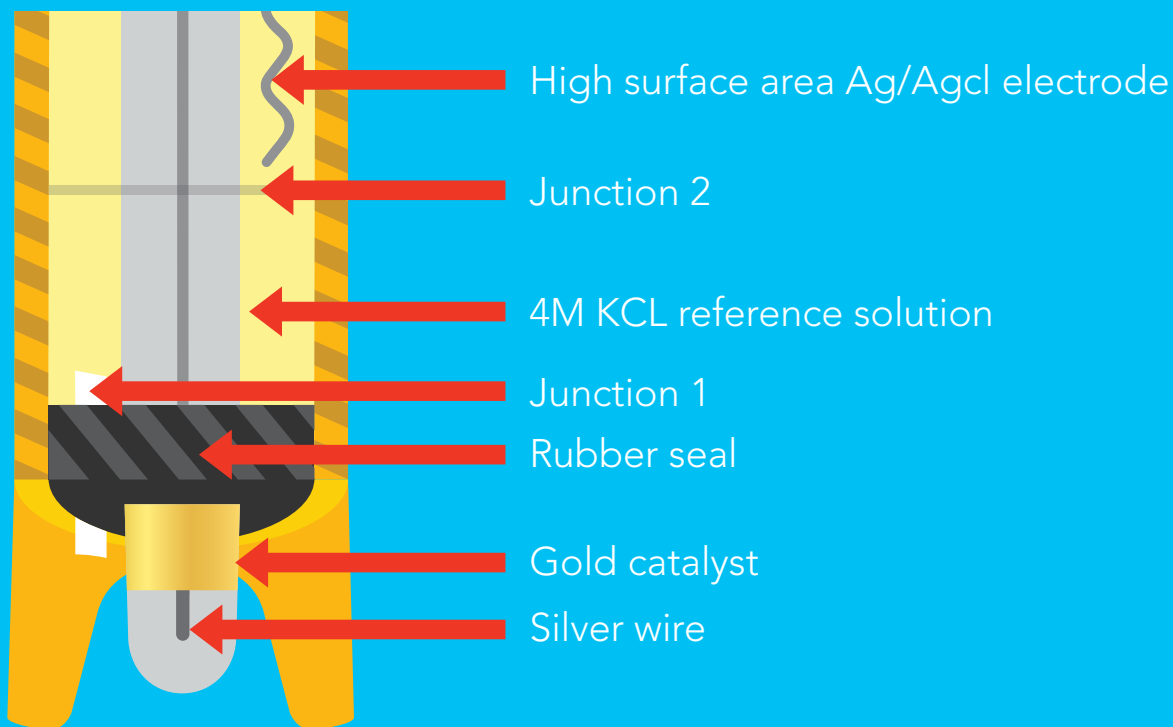

Measurements

Storage Life ~5 Years
Working Life ~2 Years

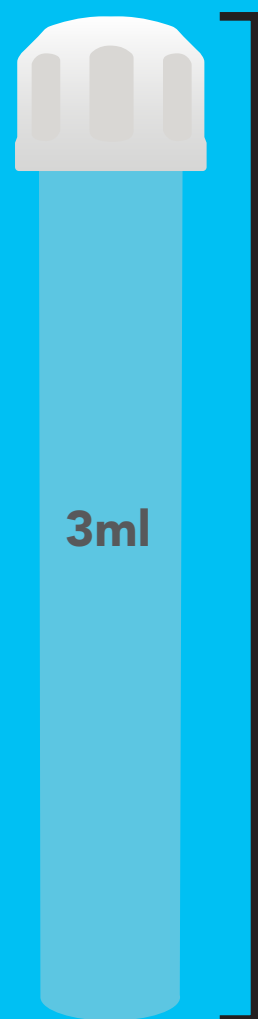

Soaker bottle

150mm
(5.9")

107mm
(4.2")

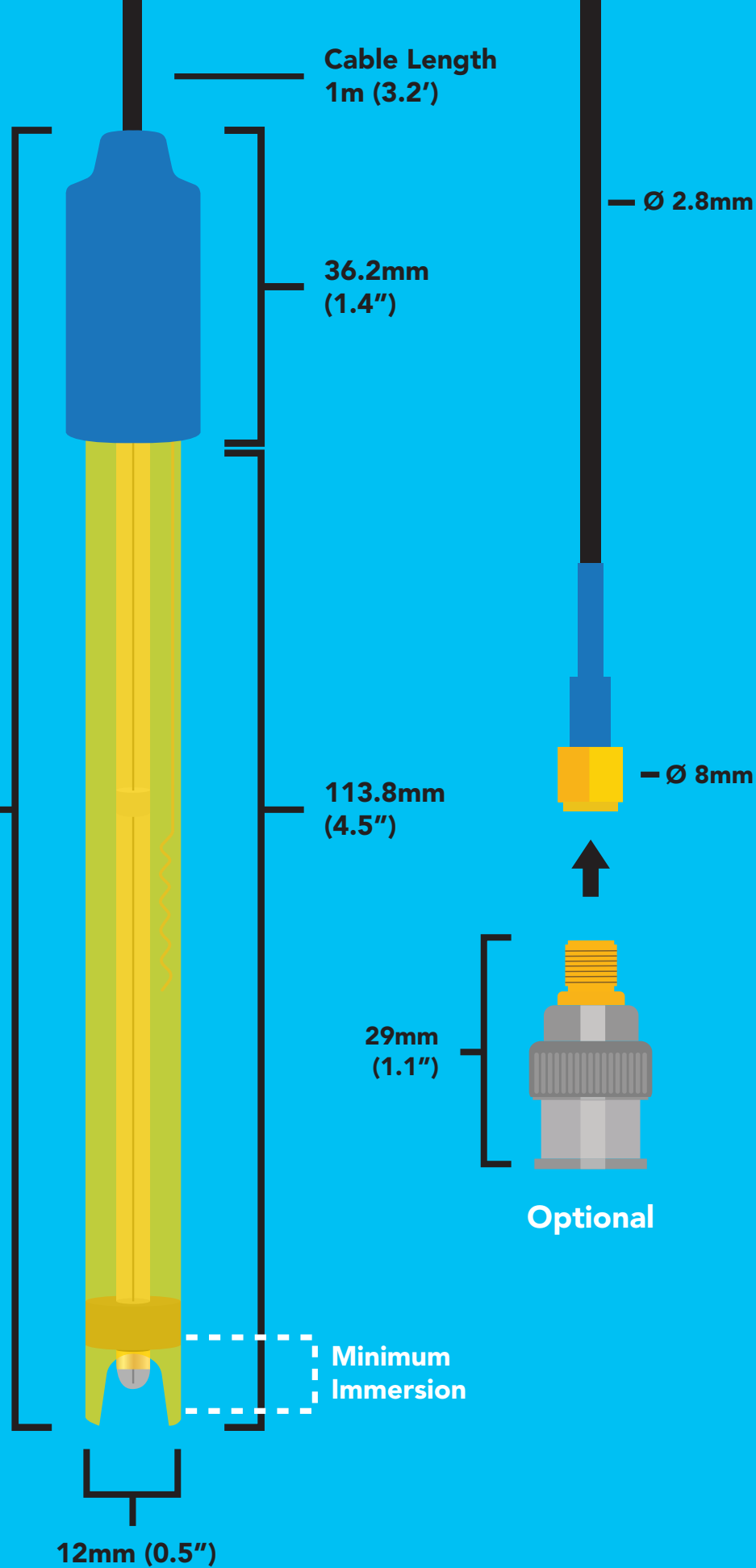

Cable Length
1m (3.2')

36.2mm
(1.4")

Ø 2.8mm

113.8mm
(4.5")

Ø 8mm

29mm
(1.1")

Optional

Minimum
Immersion

12mm (0.5")

NSF/ANSI 51 Compliant

Food Safe

Atlas Scientific LLC, hereby certifies that,

Lab Grade Gold ORP Probe

Part # ENV-40-ORP-G

Complies with NSF/ANSI Standard 51

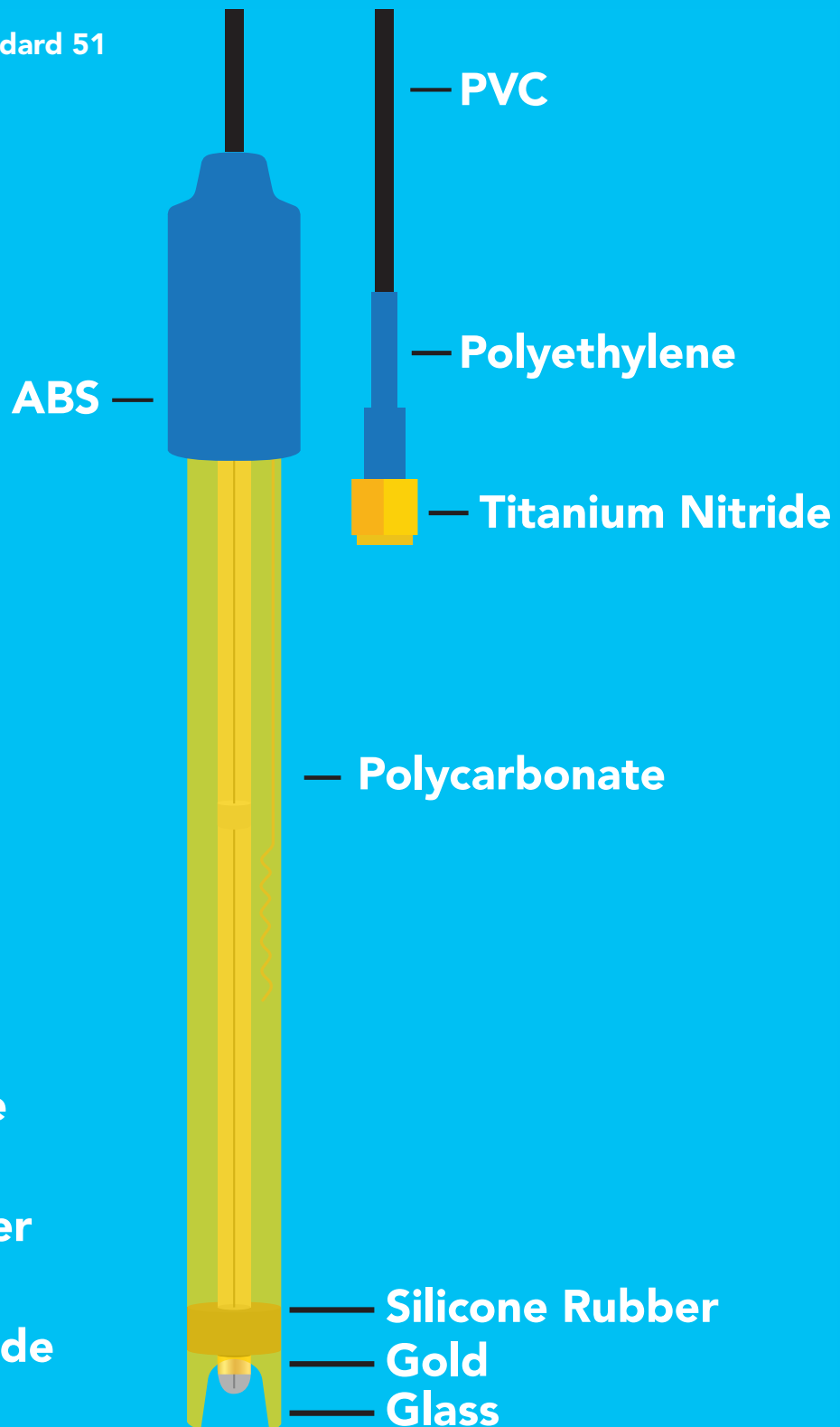

✓ **PVC**
NSF-51 Compliant

✓ **ABS**
NSF-51 Compliant

✓ **Gold**
NSF-51 Compliant

✓ **Glass**
NSF-51 Compliant

✓ **Polyethylene**
NSF-51 Compliant

✓ **Polycarbonate**
NSF-51 Compliant

✓ **Silicone Rubber**
NSF-51 Compliant

✓ **Titanium Nitride**
NSF-51 Compliant

Specifications

Max depth	70m (230')
Cable length	1 meter
Weight	45 grams
Speed of response	95% in 1 second
Dimensions	12mm x 150mm (0.5" x 6")
SMA connector	Male
Sterilization	Chemical only
Food Safe	Yes

Materials

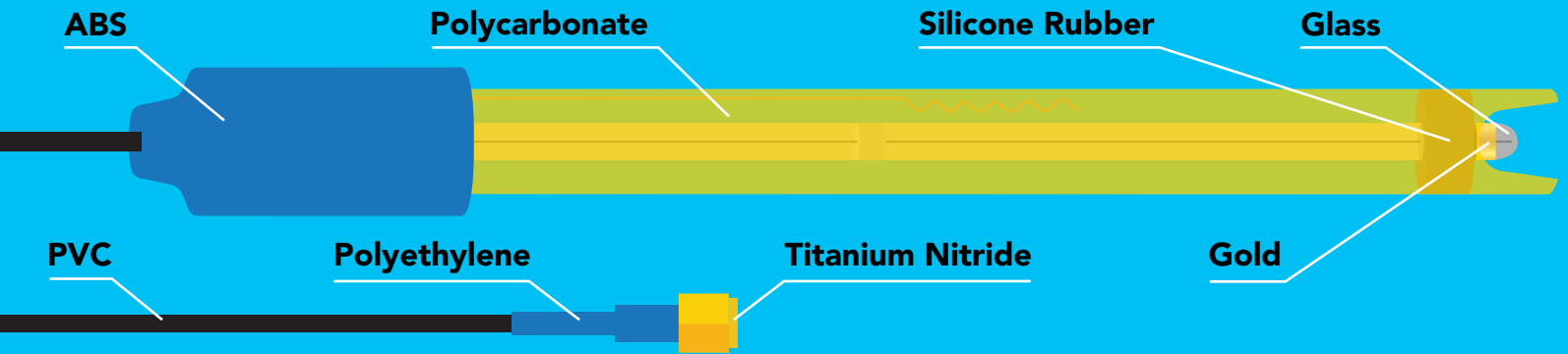

This ORP probe can be **fully submerged** in fresh or salt water, up to the SMA connector **indefinitely**.

Typical applications

- Standard lab use
- Field use
- Soil
- Samples containing heavy metals
- Hydroponics / aquaponics
- Beer, wine, alcohol, and food production

An ORP probe is a passive device that detects a current generated from the oxidation or reduction chemical substances in water. This current (which can be positive or negative) is very weak and cannot be detected with a multimeter, or an analog to digital converter.



Result will **Often** read zero.

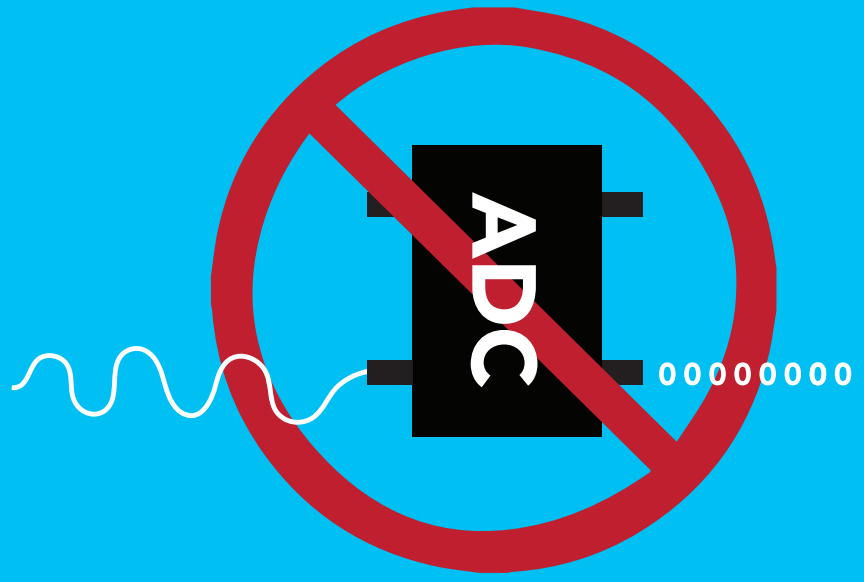

Result will **Often** read zero.

How often do you need to recalibrate an ORP probe?

Because every use case is different, there is no set schedule for recalibration.

If you are using your probe in a fish tank, a hydroponic system or any environment that has generally weak levels of chemical reactions you will only need to recalibrate your probe once per year for the first 2 years. After that every ~6 months.

If you are using the ORP probe in batch chemical manufacturing, industrial process, or in a solution that is known to have strong chemical reactions, then calibration should be done monthly or in extreme cases after each batch.

NEVER EXTEND THE CABLE
WITH CHEAP JUMPER WIRES!

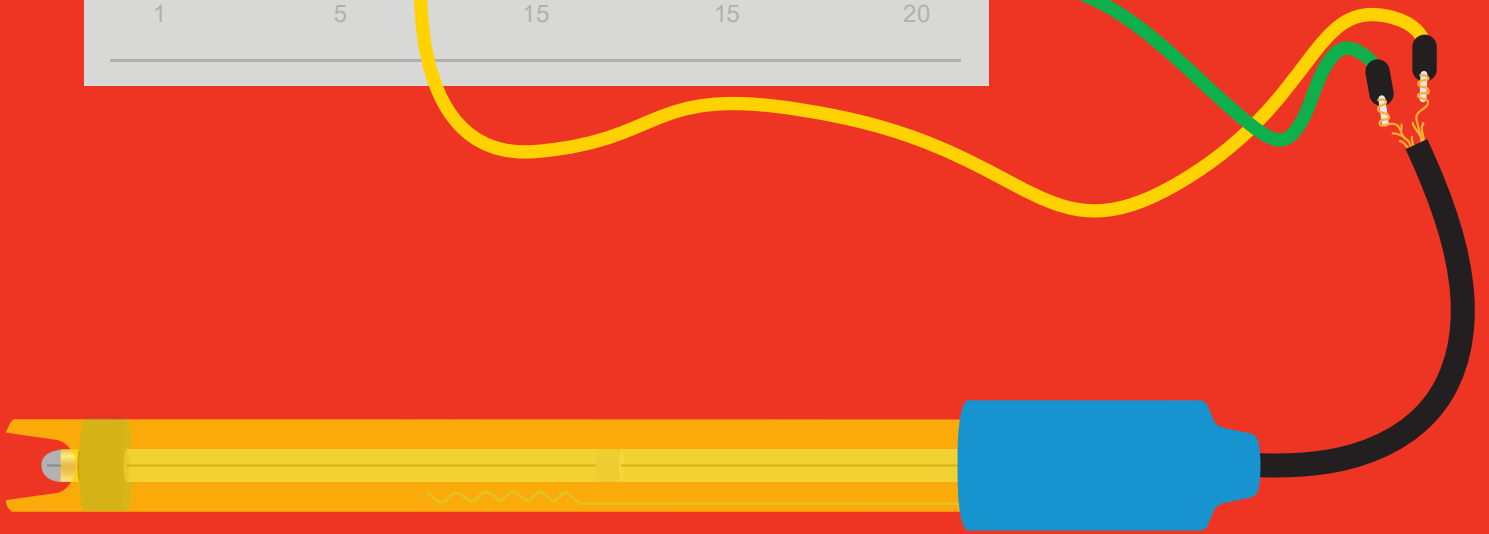
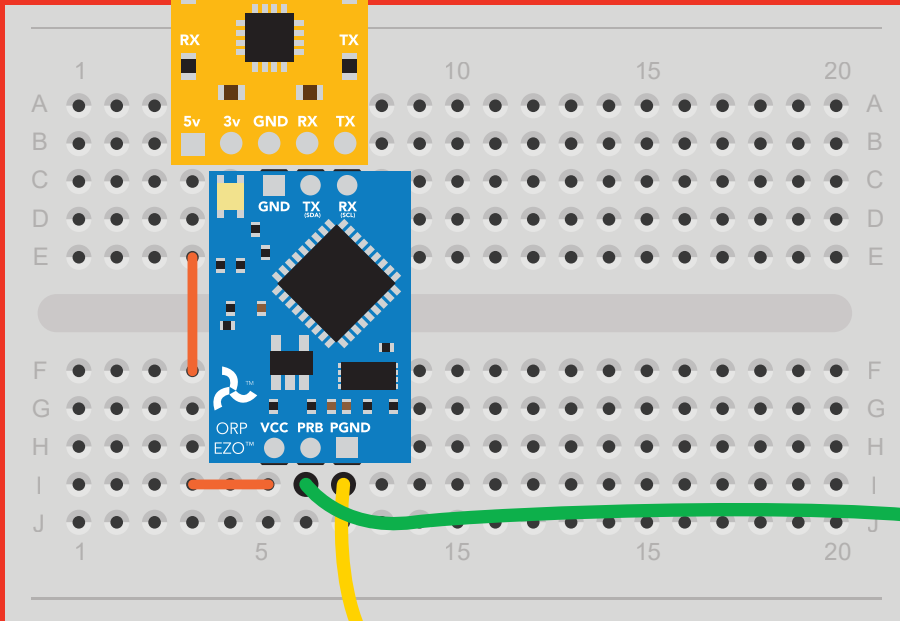

**DO NOT CUT THE PROBE CABLE
WITHOUT REFERRING TO **THIS DOCUMENT!****

**DO NOT MAKE YOUR OWN
UNSHIELDED CABLES!**

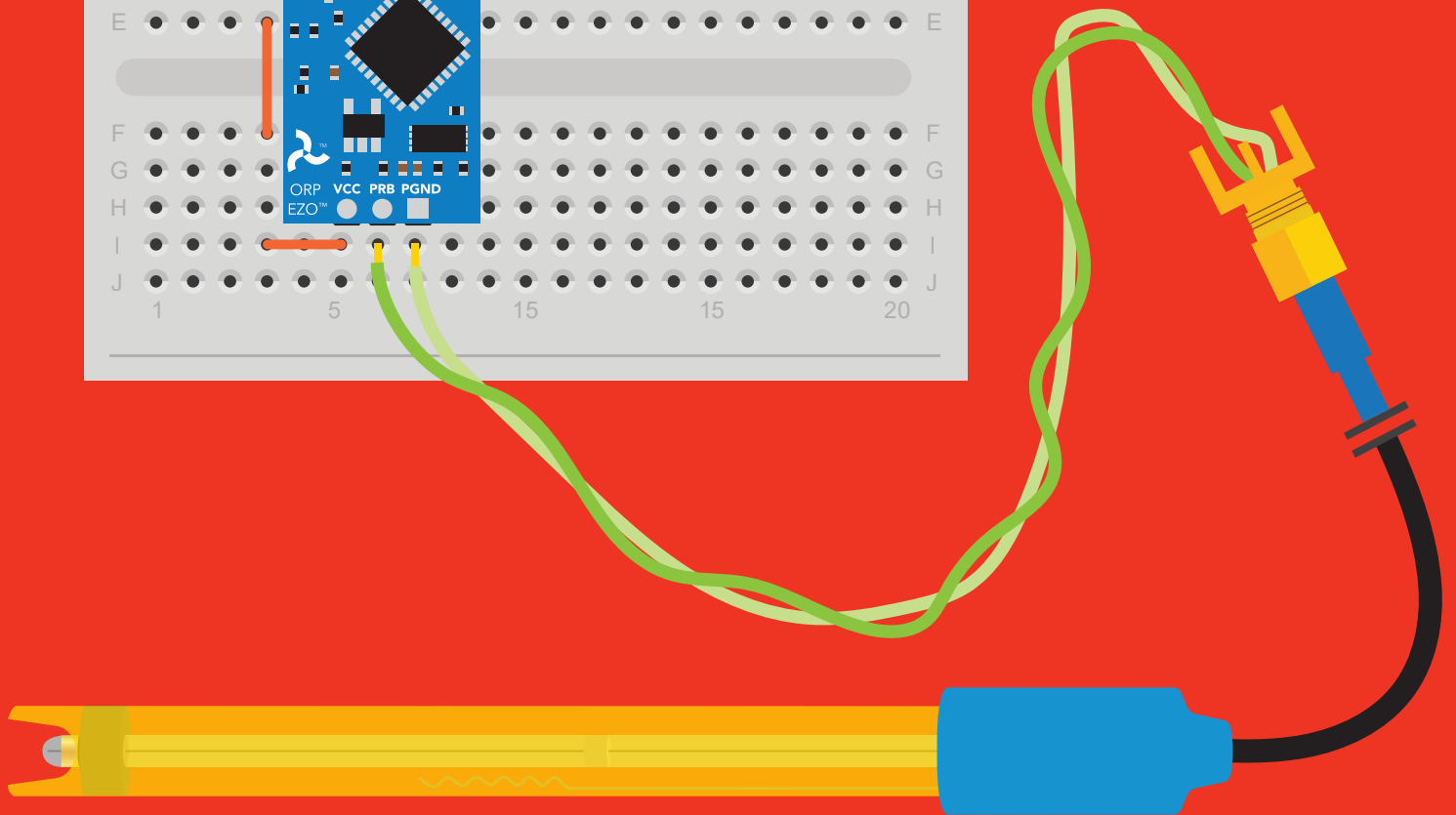
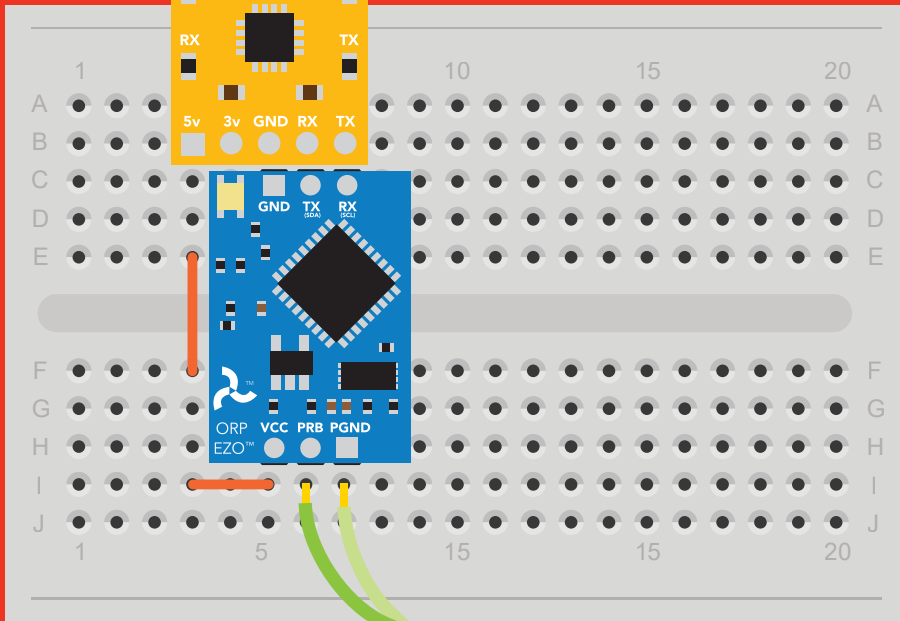

ONLY USE SHIELDED CABLES.

Extending the probe cable length

You can extend the cable to greater than 100 meters with no loss of signal. Atlas Scientific has tested up to 300 meters without a problem, however you run the risk of turning your ORP probe into an antennae, picking up noise along the length of your cable.

If you want to extend your cable, we recommend that you use proper isolation, such as the **Basic EZO™ Inline Voltage Isolator**, or an **i2 InterLink**. Be sure to calibrate your probe with the extended cable.

Extending a probe cable can be easily done with our **SMA Extension Cables**. Simply connect the SMA end of the probe to the Extension cable, and you are all set.

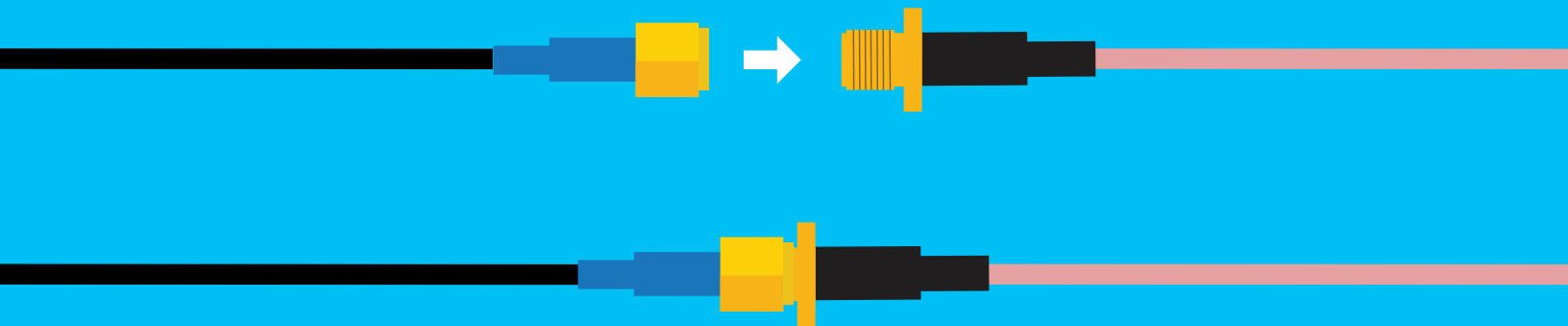

If you need to water proof a SMA connection, we highly recommend using a product like **Coax Seal** to safely cover and prevent any water damage that may occur.

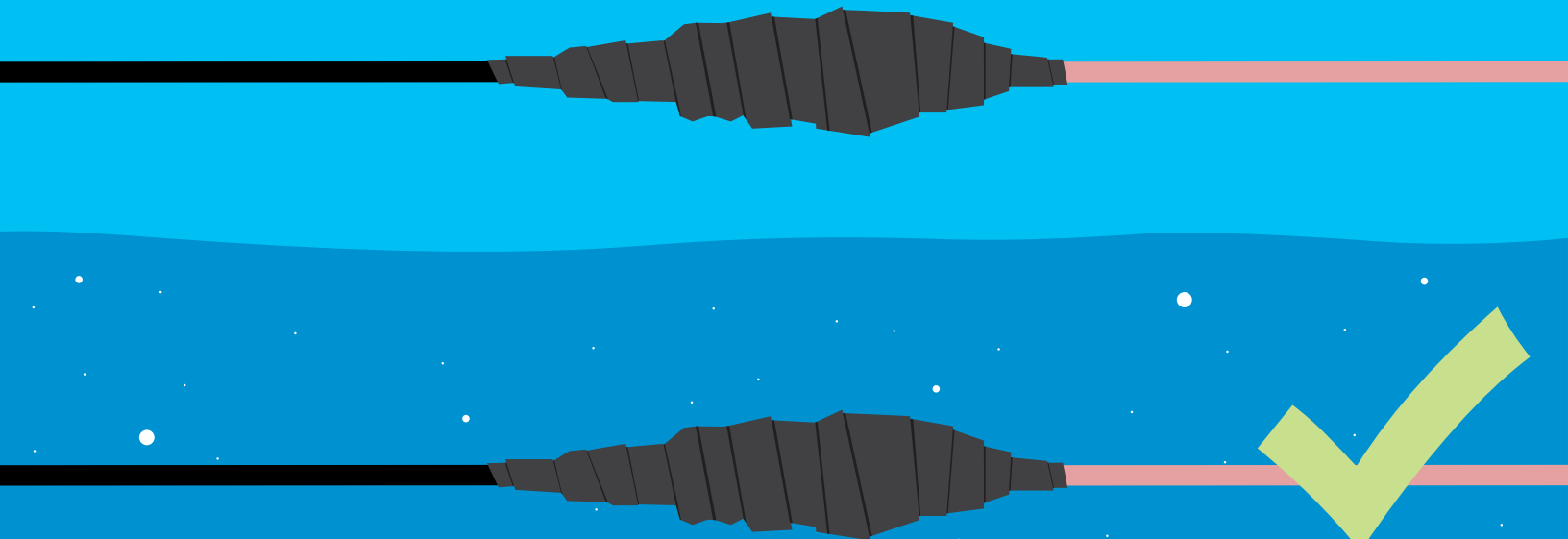

Water proof

Helpful operating tips

ORP probes must stay wet and cannot be allowed to dry out, this is why every ORP probe is shipped in a plastic soaker bottle containing ORP probe storage solution. The probe should remain in the bottle until it is used. If the probe is used infrequently, the bottle and its solution should be saved and the probe stored inside.

- 1 To remove the soaker bottle from the probe, hold the soaker bottle by the cap and turn the bottle until it separates from the cap; Then slide the cap off.

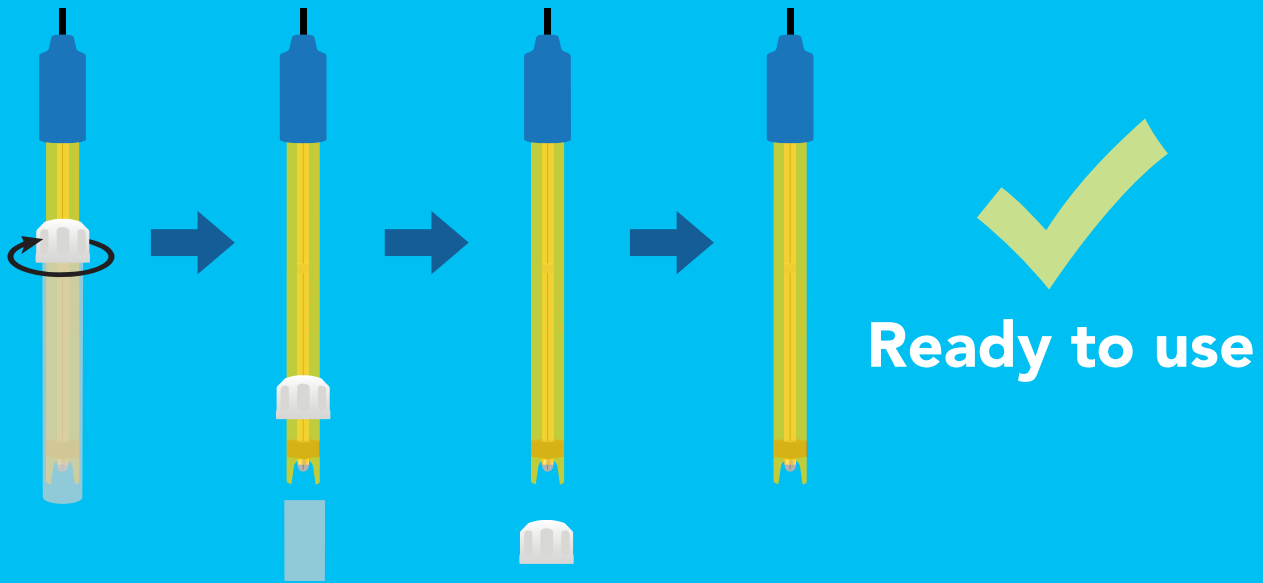

- 2 Vigorously stir the probe in the sample, calibration solution, or rinse solution. This action will bring solution to the probes surface quicker and improve the speed of response.



Probe cleaning

Coating of the ORP bulb can lead to erroneous readings including shortened span. The type of coating will determine the cleaning technique. Soft coatings can be removed by vigorous stirring or by the use of a squirt bottle. Organic chemical, or hard coatings, should be chemically removed. A light bleach solution or even a 5 – 10% hydrochloric acid (HCl) soak for a few minutes, often removes many coatings. **Do not use abrasive materials on the ORP probe.**

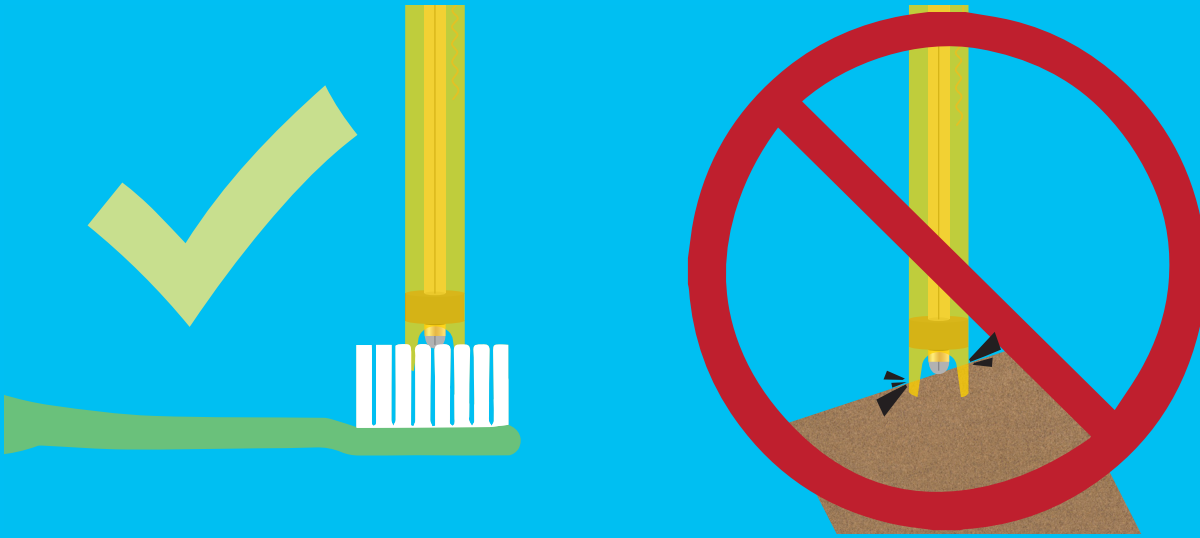

1980's — Today



Despite appearances
THE KCl CREEP
is really quite harmless.

The white crystals
you may find on your electrode
are formed by potassium chloride (KCl)
from the electrode filling solution.
Rinse the KCl from the electrode
with distilled water and proceed as usual.



Dried KCl residue
from ORP storage
solution

Decades later...

KCl continues to behave the same way.

If you encounter the "KCl CREEP" rinse off your probe with water,
and carry on. **Your probe is not damaged.**