

RTD³

Industrial Temperature Transmitter

Reads	Temperature (up to 3 probes)
Full Range	-126 °C to 1,254 °C
Range with Atlas industrial probe	-55 °C to 220 °C
Accuracy	+/- 0.1 °C
Scale	°C or °F
Calibration	Single point @0 °C
Supported probes	Any type / brand of PT-100 or PT-1000 RTD
Mount	35mm Din rail
Output	4 – 20mA
Operating voltage	9VDC – 36VDC

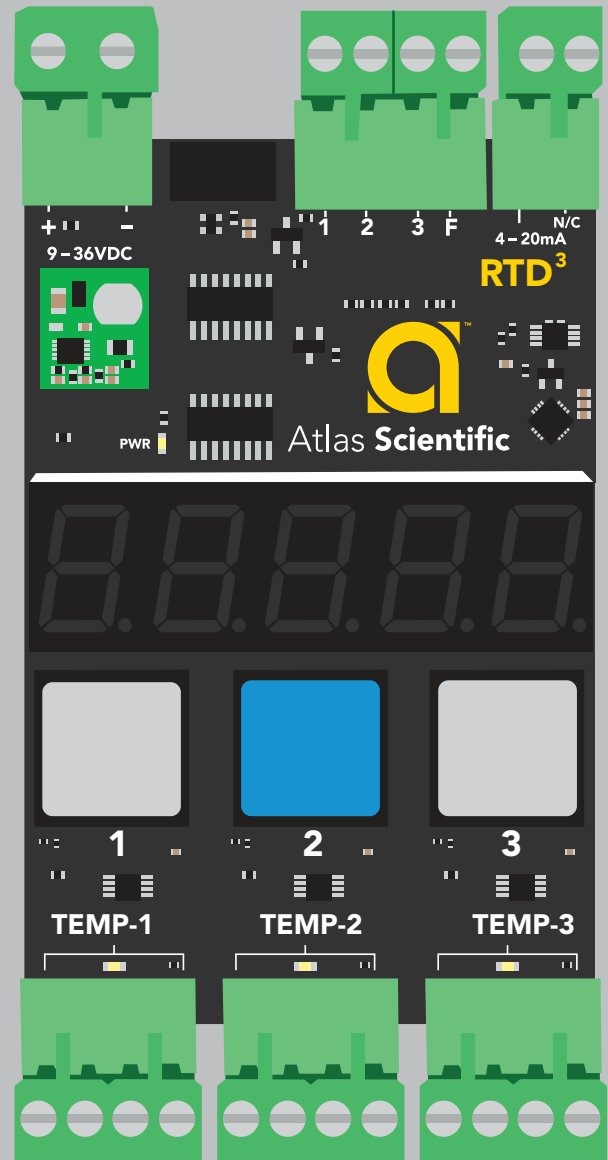
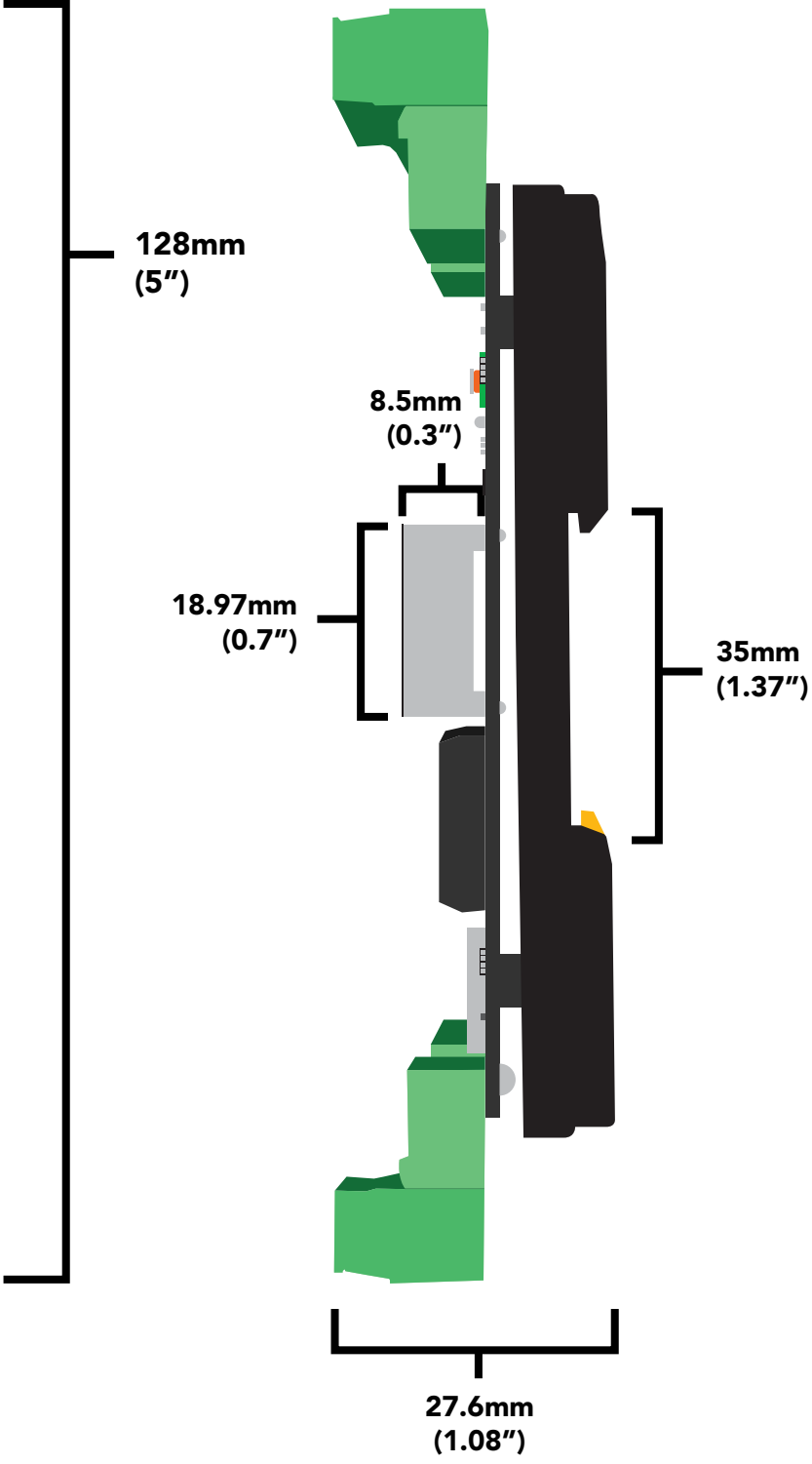
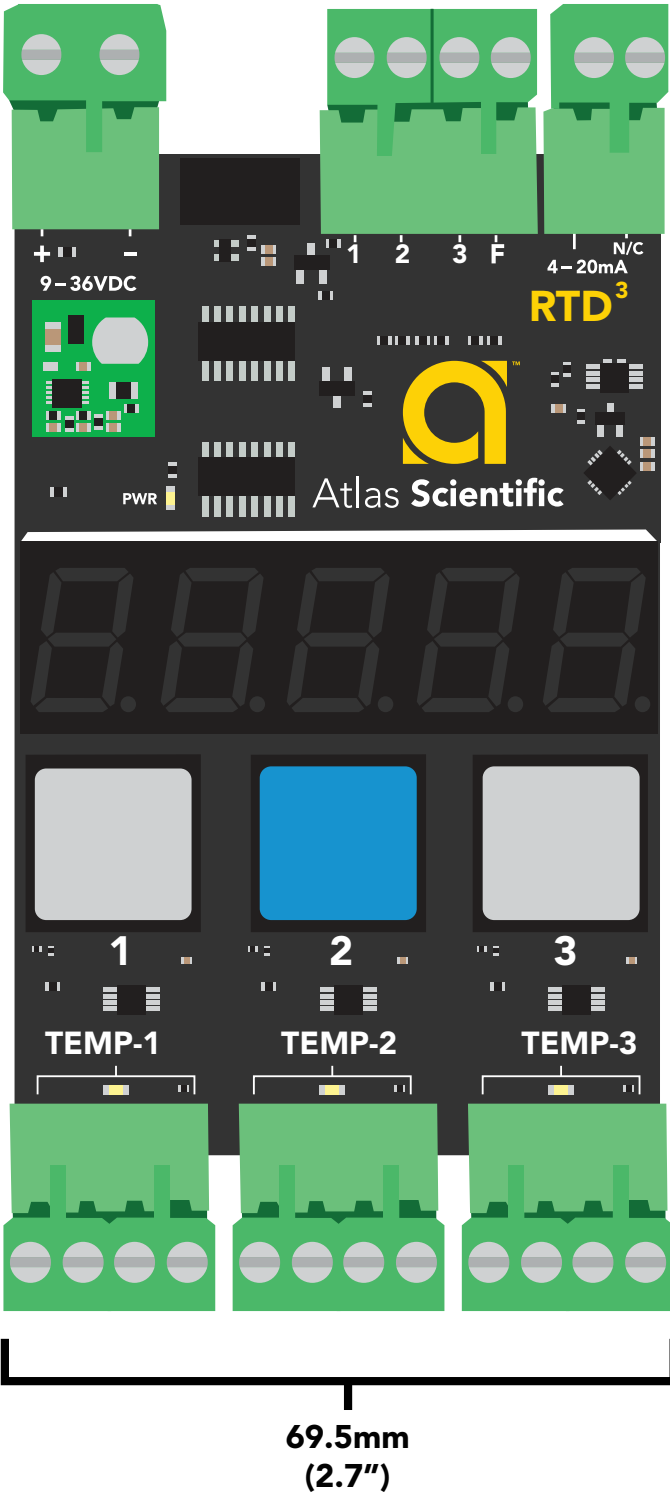

Table of contents

Transmitter dimensions	3	Power connection	6
Mounting	4	Temp probe connection	7
Wiring diagram	5	4 – 20mA connection	9
Temperature sensing range	10		
Setting the temperature scale and sensing range	11		
4 – 20mA transmission	12		
Reading 4 – 20mA output with a multimeter	13		
Temp to 4 – 20mA equation	14		
Reading different temperature probe channels with a PLC	15		
Fault detect line	16		
Calibration	17		
Resetting calibration	18		
Auto scrolling between channels	19		

Transmitter dimensions



Mounting

The RTD³ Industrial Temperature Transmitter is specifically designed to be mounted to a 35mm din rail. To detach the transmitter from the din rail, pull down on the din rail release notch.

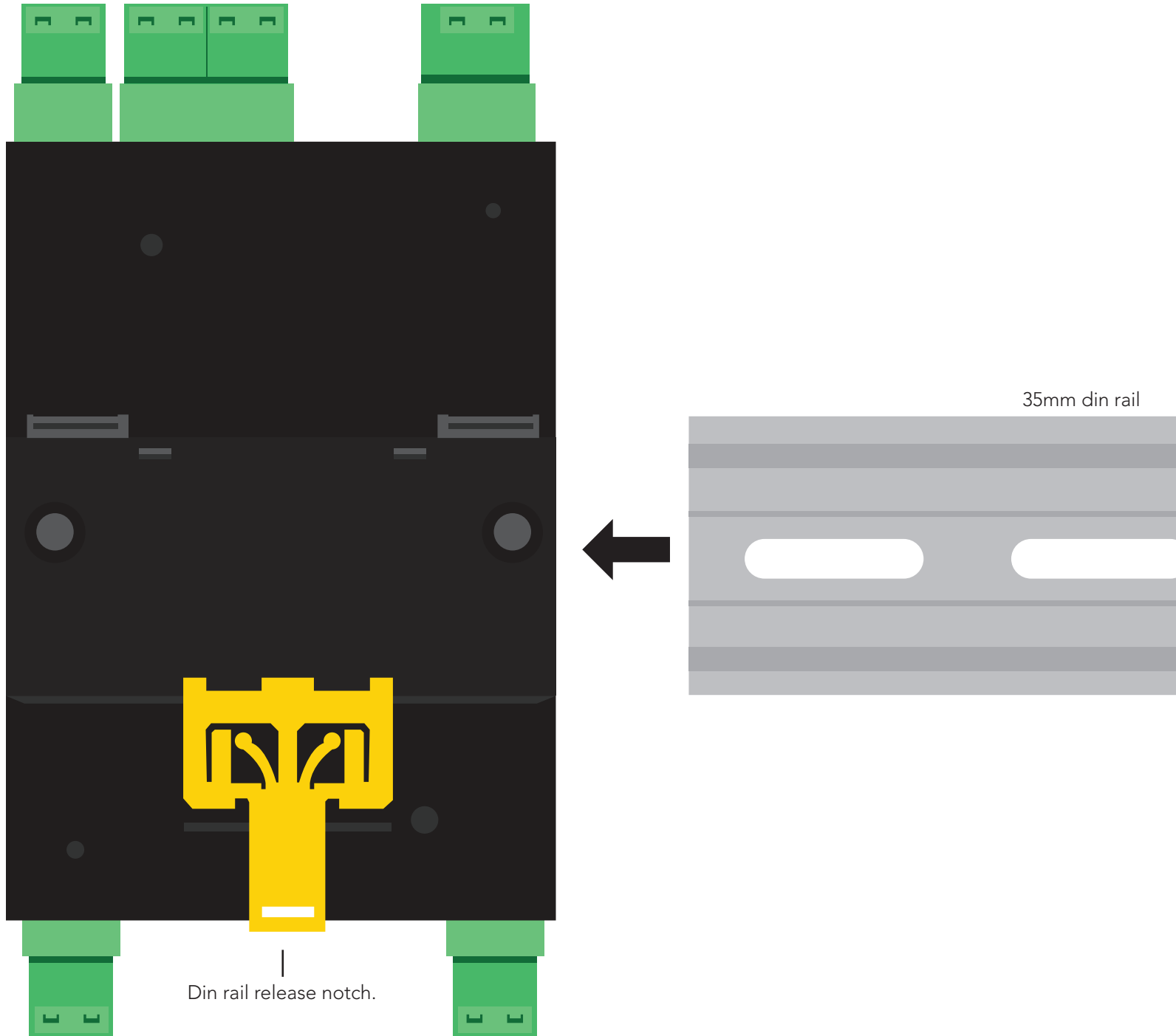

Wiring diagram

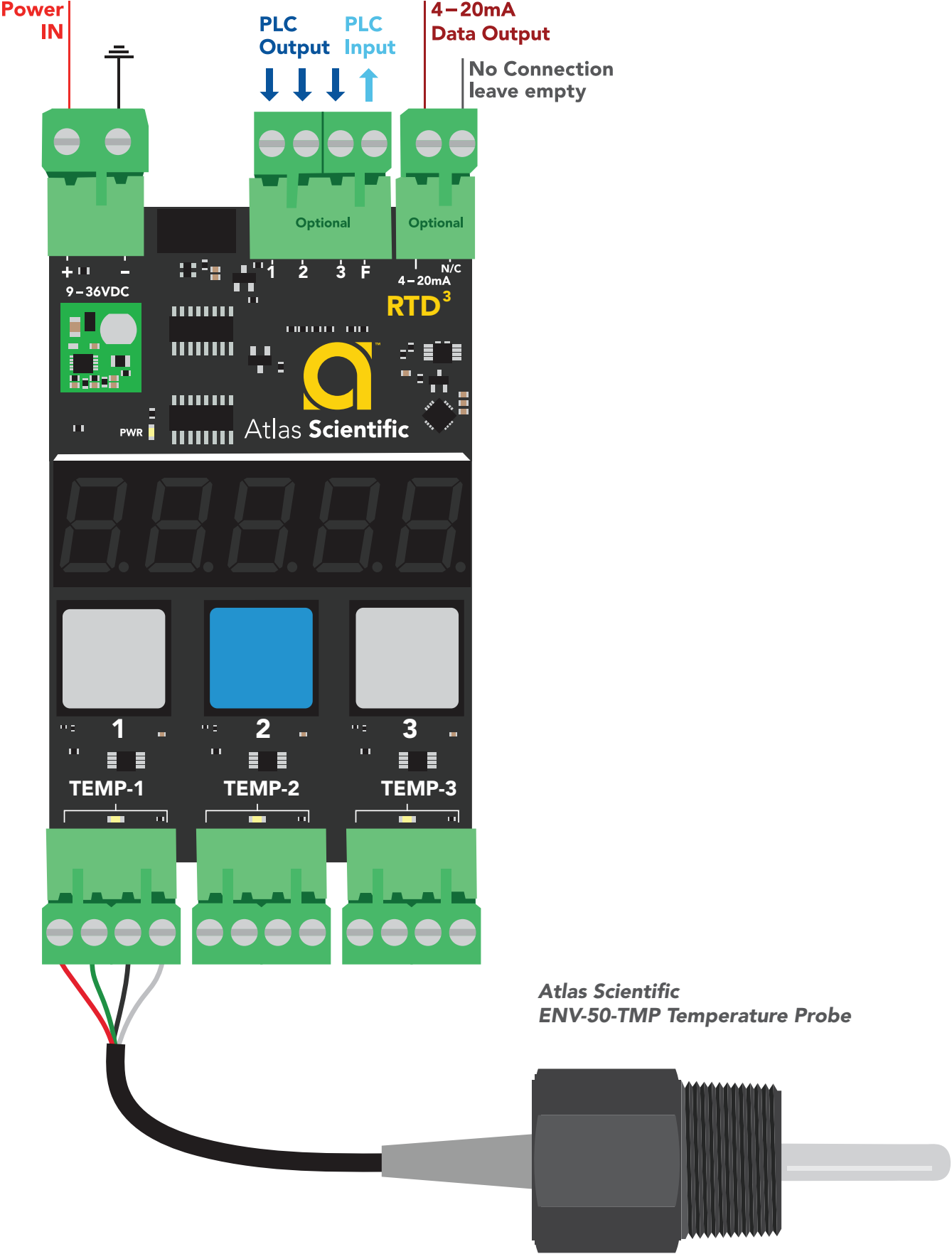

Power connection

Any DC voltage from 9V – 36V can be used to power the RTD³ Industrial Temperature Transmitter. The power connector is keyed differently and is larger than the other connectors.

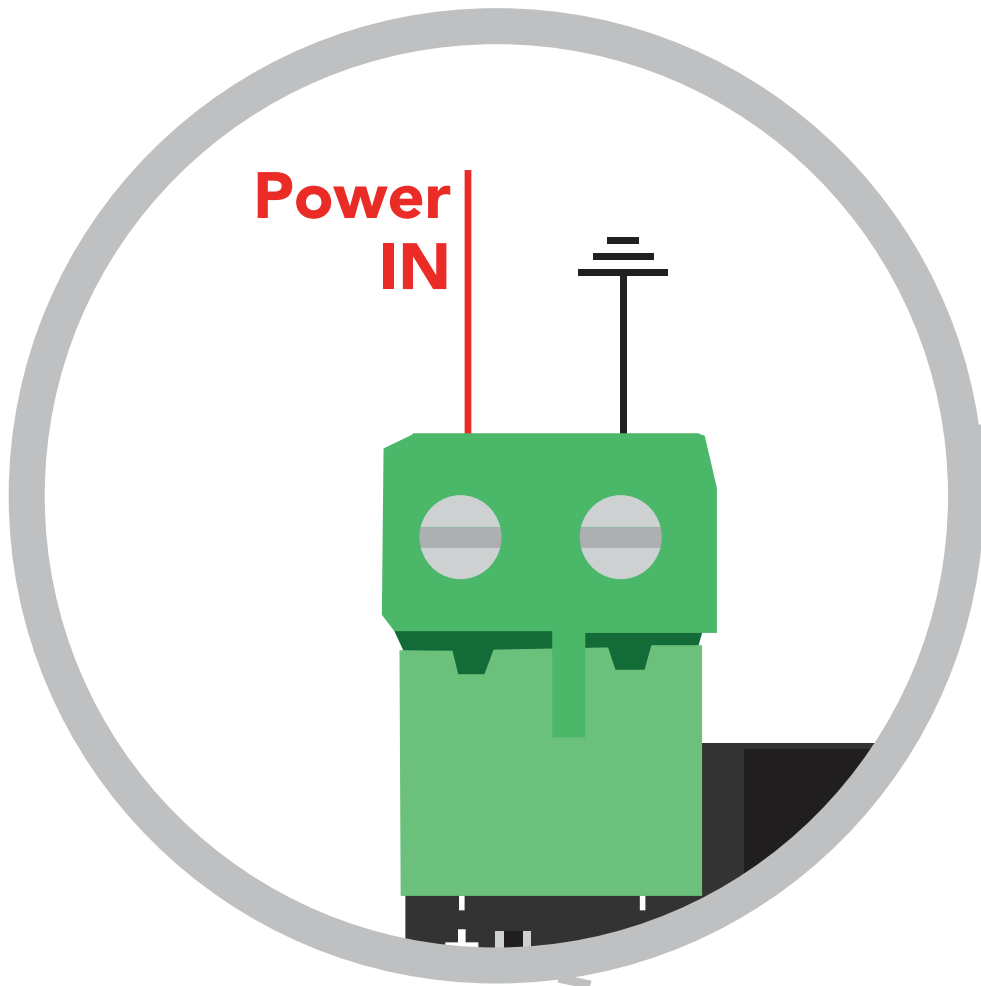

Power consumption table

VDC	mA
9	70
12	52
24	28
36	20

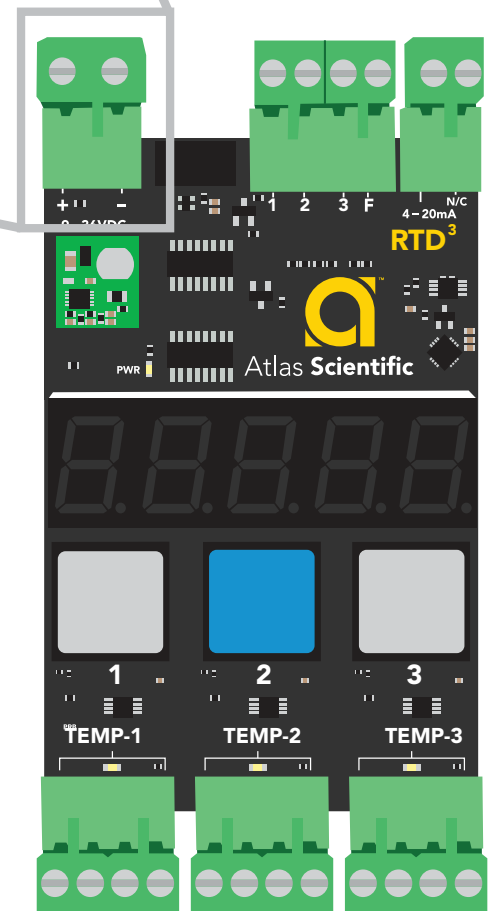

The RTD³ Industrial Temperature Transmitter must be connected to a power source that provides a smooth, ripple free DC voltage. Any DC power supply designed for a PLC should be sufficient. Connecting this device to a cheap AC adapter also known as a "wall wart" may interfere with the devices ability to provide stable readings .

Temp probe connection

Any off the shelf PT-100 or PT-1000 temperature probe can be used with the RTD³ Industrial Temperature Transmitter. The PT-100 or PT-1000 temperature probe can be a 2, 3 or 4 wire probe. For best results, use Atlas Scientifics **ENV-50-TMP temperature probe**.

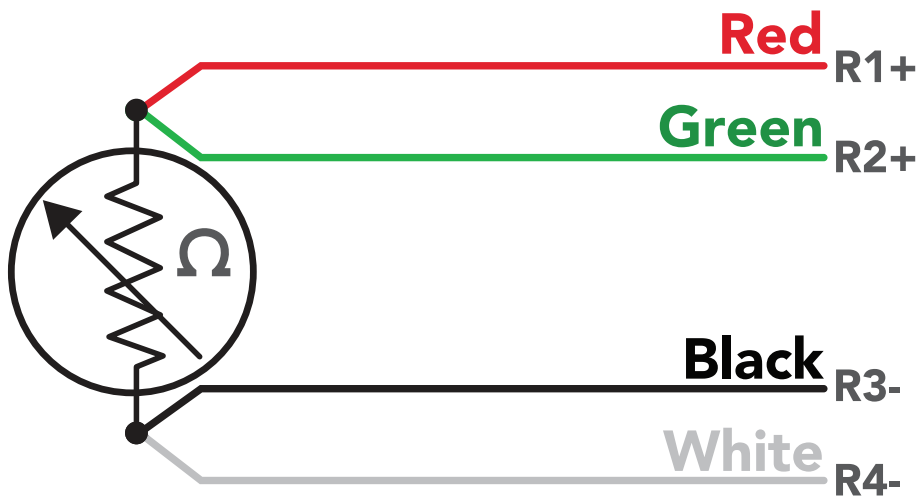

This illustration shows the internal wiring of the ENV-50-TMP temperature probe.

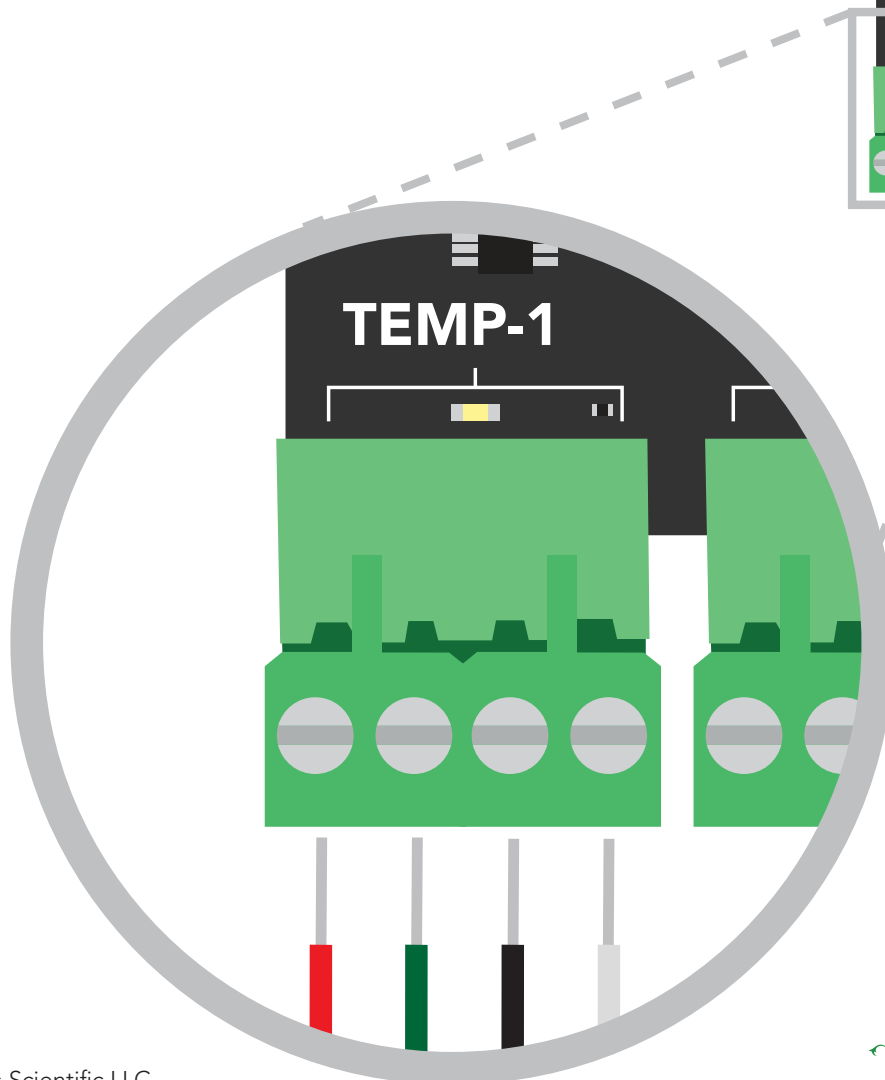
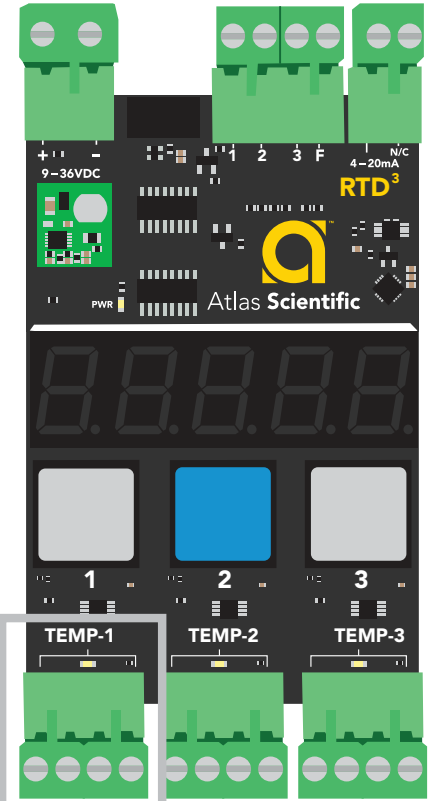

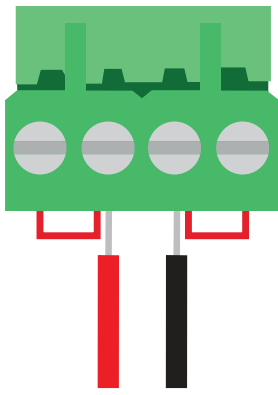

Two wire connection

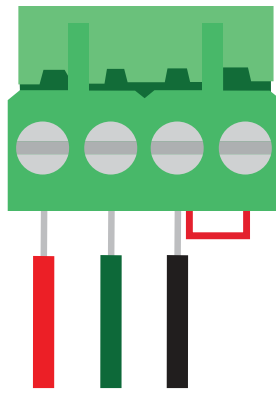

Three wire connection

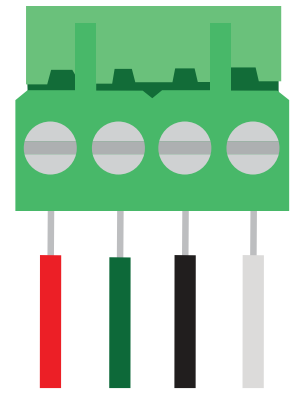

Four wire connection



Press the button above the connected sensor to see its temperature.



If no sensor is connected or the sensor is connected incorrectly "E-Prb" will be displayed.

4 – 20mA connection

Connecting the 4 – 20mA data output to your PLC, allows the RTD³ Industrial Temperature Transmitter to communicate with your PLC.

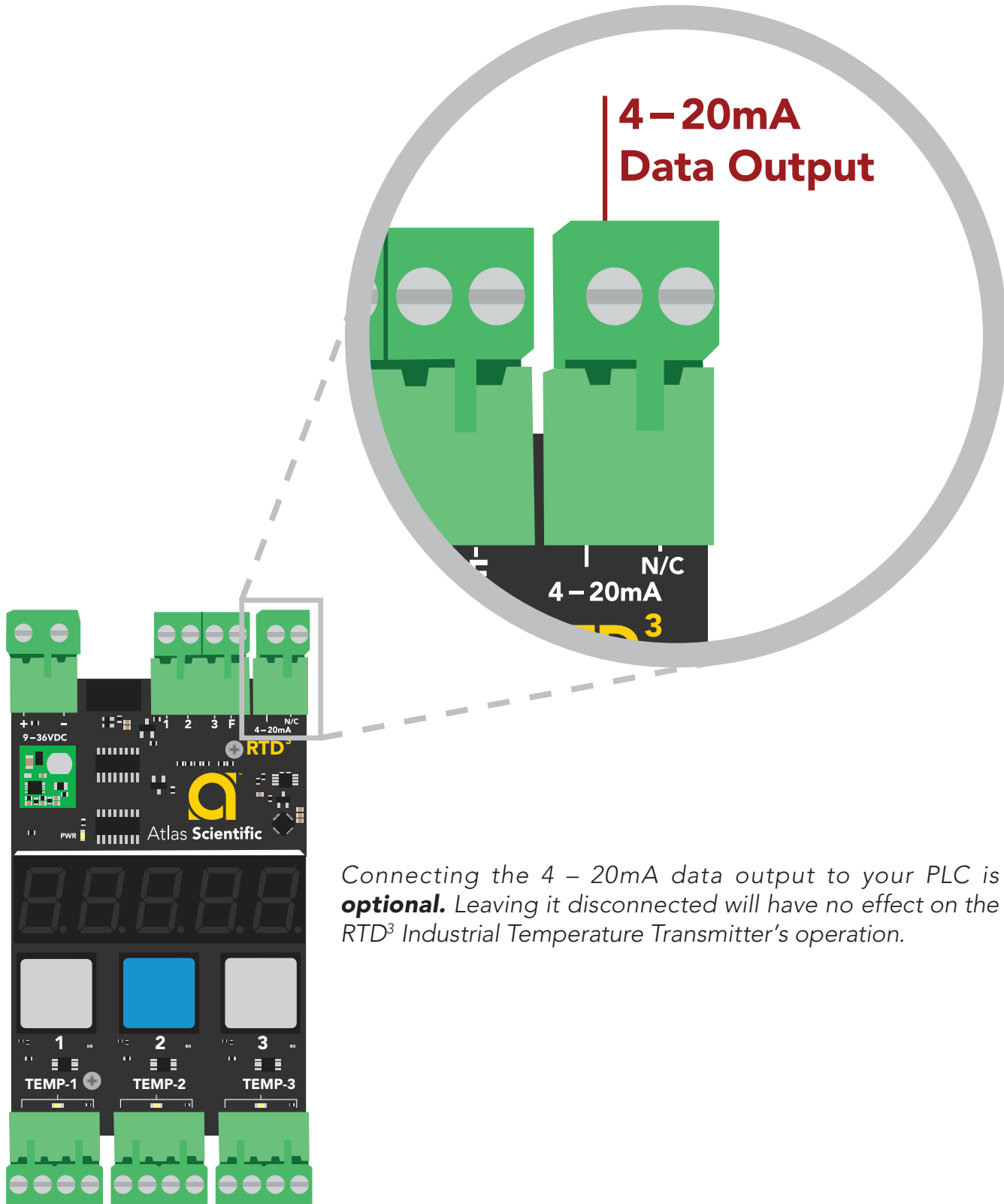

Connecting the 4 – 20mA data output to your PLC is **optional**. Leaving it disconnected will have no effect on the RTD³ Industrial Temperature Transmitter's operation.

Temperature sensing range

The RTD³ Transmitter can be set to one of four possible measurement ranges.

1. **-55 to 220 °C** *DEFAULT
2. **-100 to 400 °C**
3. **-100 to 1,200 °C**
4. **-180 to 180 °C**

The default temperature range covers the full sensing range of the Atlas Scientific industrial temperature probe. While the range of the probe may seem limited, it was designed to cover to most common temperature ranges used by our customers.

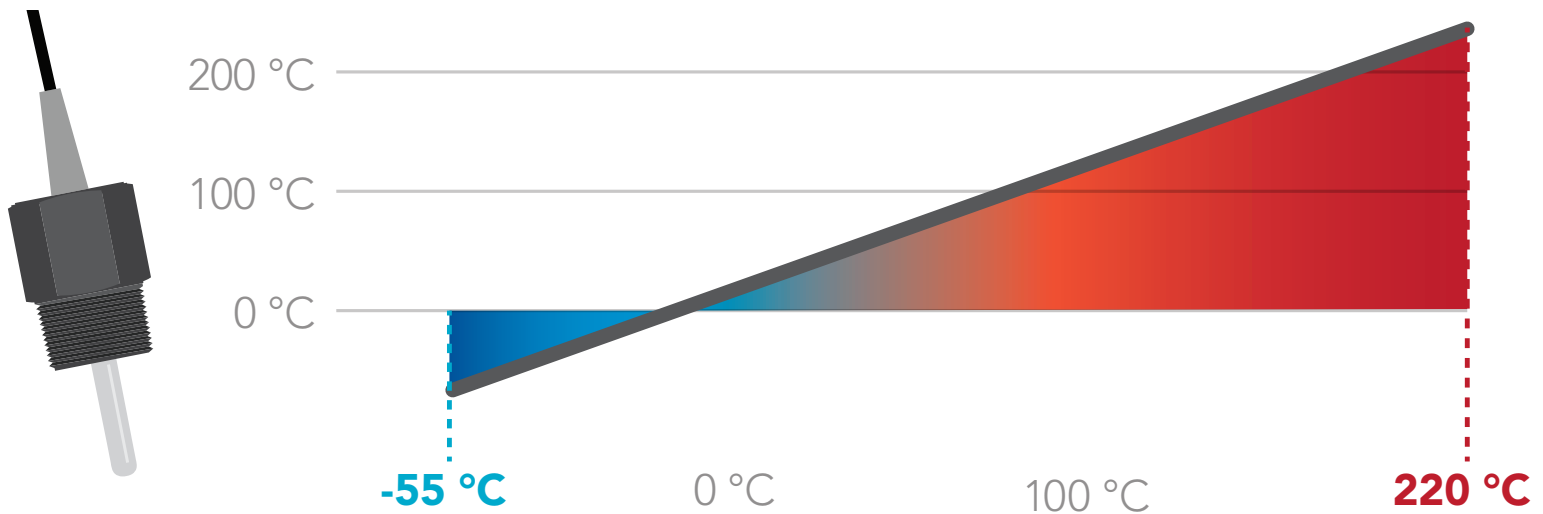

The ENV-50-TMP temperature probes sensing range

To monitor a different temperature range using the RTD³ Transmitter, simply connect a 3rd party PT-100 or PT-1000 probe that better suits your applications needs. There will be no compatibility issues if your sensor meets these requirements:

1. **Sensor must be a PT-100 or PT-1000 RTD.**
2. **Sensor must be a 2, 3, or 4 wire RTD.**

Setting the temperature scale and sensing range

DEFAULT

Scale: Celsius

Range: -55°C to 220°C

To change the default settings, hold down both the **1** and **3** buttons for three seconds.

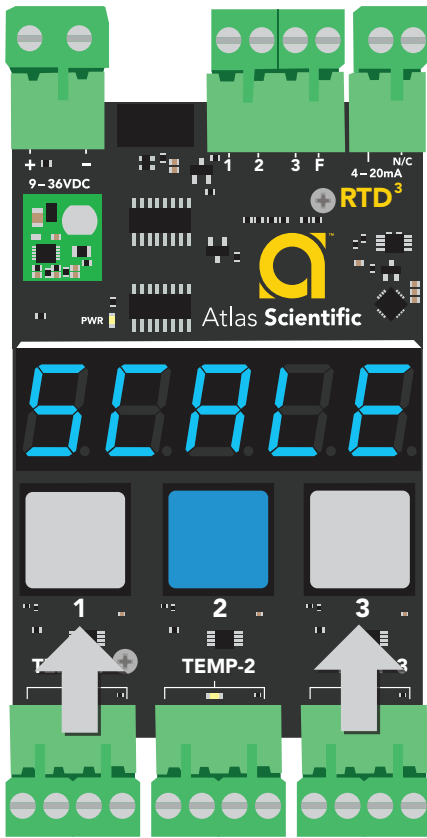

3 seconds

The first option will be **SCALE** press button **2** to toggle between °C and °F. Press button **1** to confirm and move to range selection.

Press button **2** to scroll through the 4 different temperature ranges.

1. **220°C** ***DEFAULT**
2. **400°C**
3. **1,200°C**
4. **180°C**

Press button **1** to confirm and return to normal operations.

4 – 20mA transmission

Default range -55°C to 220°C

The temperature value that is visible on the seven segment LED screen is also, simultaneously transmitted through the 4 – 20mA data output.

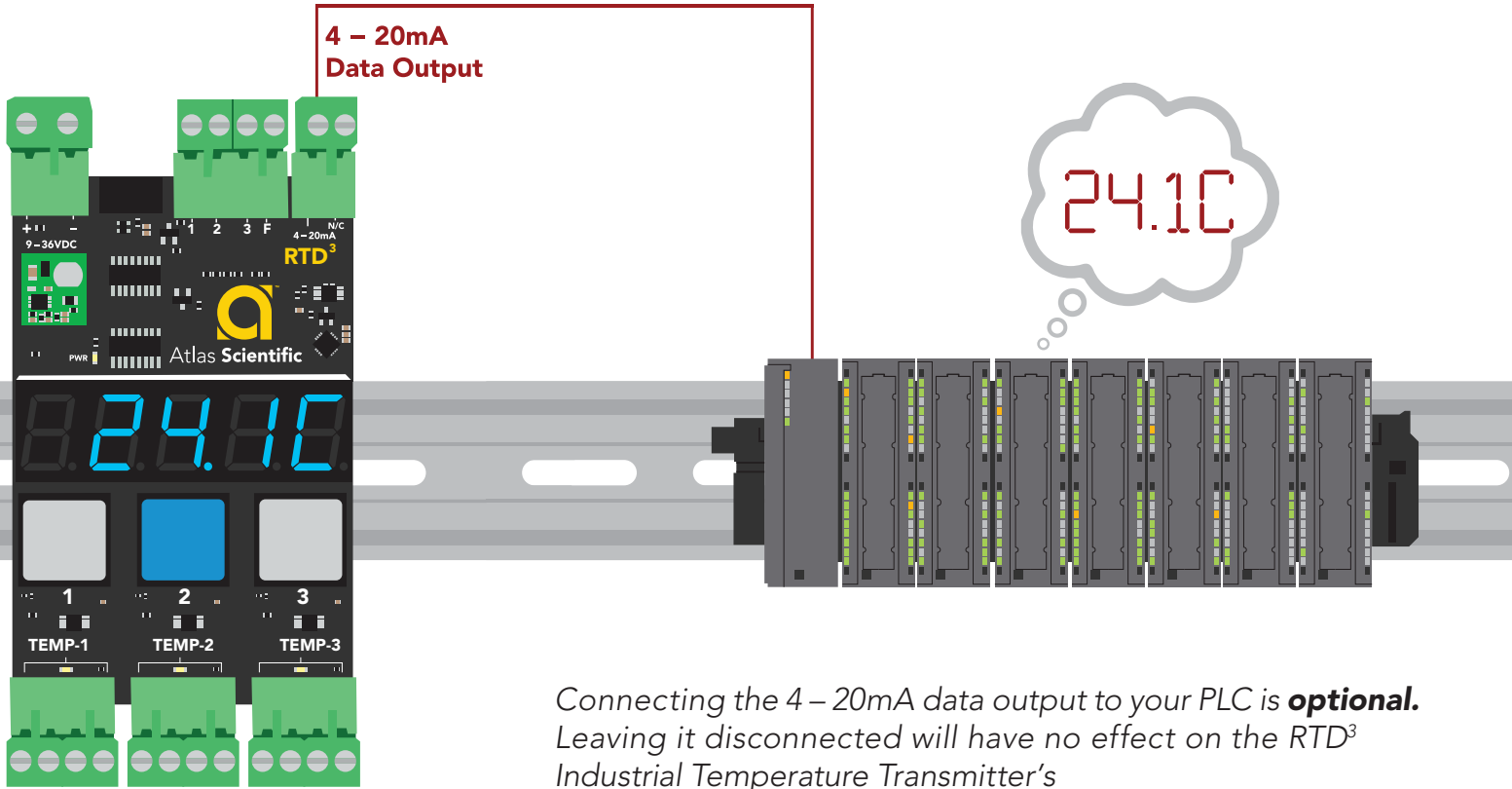

Connecting the 4 – 20mA data output to your PLC is **optional**. Leaving it disconnected will have no effect on the RTD³ Industrial Temperature Transmitter's

Advanced

4 – 20mA max load resistance

$$R_{max} = \frac{(V_{in} - 1)}{0.026}$$

R = the total resistive load on the line.

V = the voltage powering the transmitter.

Reading 4–20mA output with a multimeter

To debug the RTD³ Industrial Temperature Transmitters output, connect it to a multimeter as shown (make sure the multimeter is set to "mA").

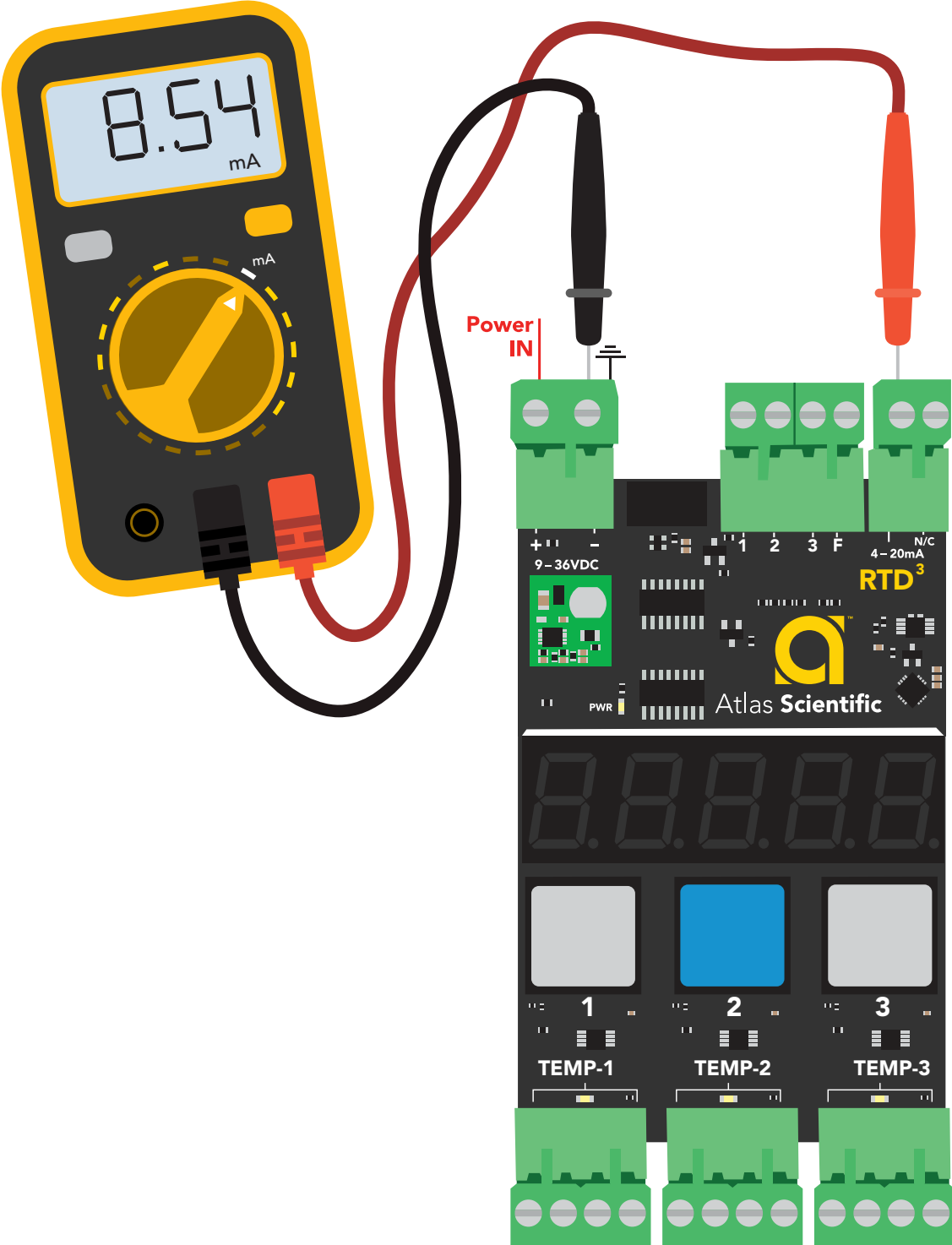

Temp to 4–20mA equation

Option 1

-55 to 220°C ***DEFAULT**

$$T = \left(\frac{(i-4)}{16} * 275 \right) - 55$$

i	Temp
4ma	-55
8ma	13.7
12ma	82.5
20ma	220

Option 2

-100 to 400°C

$$T = \left(\frac{(i-4)}{16} * 500 \right) - 100$$

i	Temp
4ma	-100
8ma	25
12ma	150
20ma	400

Option 3

-100 to 1,200°C

$$T = \left(\frac{(i-4)}{16} * 1300 \right) - 100$$

i	Temp
4ma	-100
8ma	225
12ma	550
20ma	1,200

Option 4

-180 to 180°C

$$T = \left(\frac{(i-4)}{16} * 360 \right) - 180$$

i	Temp
4ma	-180
8ma	-90
12ma	0
20ma	180

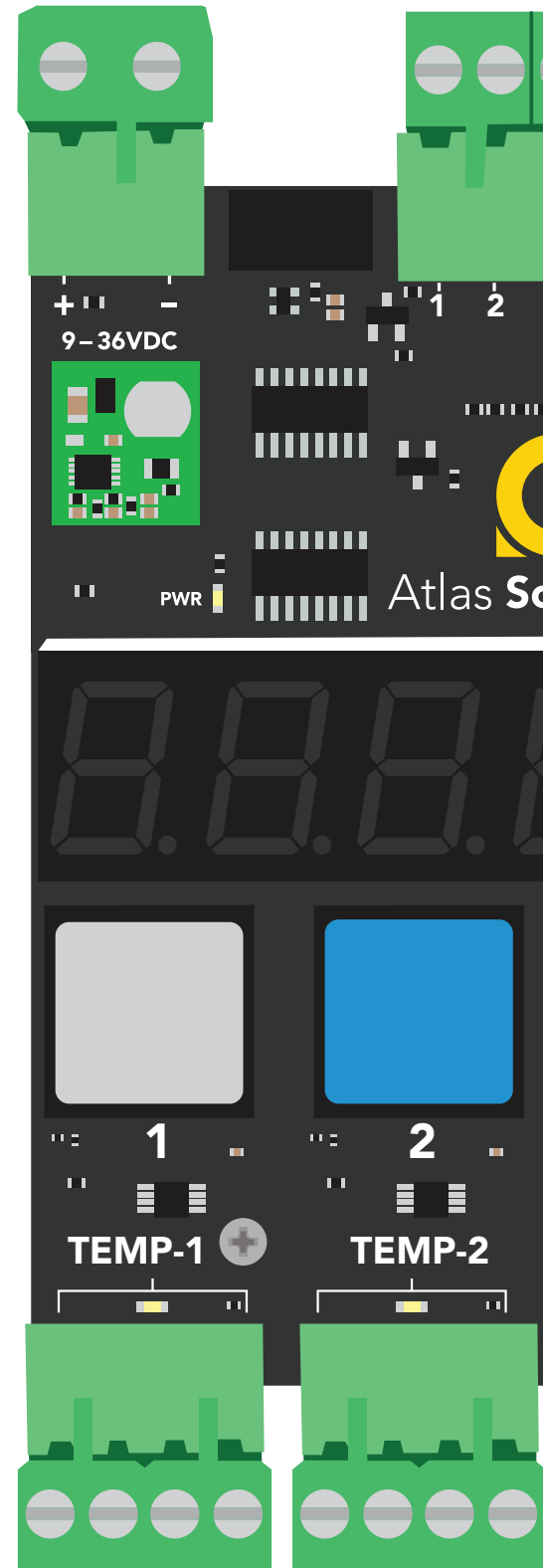

Reading different temperature probe channels with a PLC

By default, the RTD³ will be set to Temp-1. The 4–20ma readings will be the readings from that probe. To get readings from another channel use the PLC control pins.

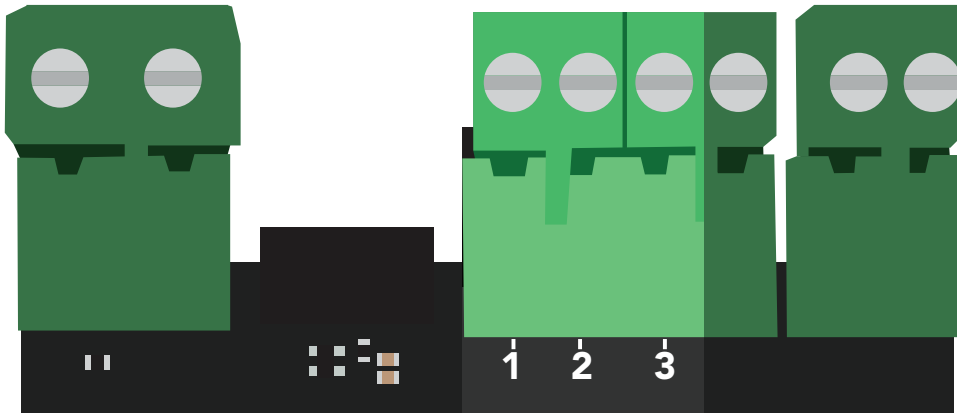

By setting a control pin high, the RTD³ will switch to that channel. Use the same voltage used to power the RTD³ as your switching voltage. Temperature reading will be valid 10ms after switching to the new channel.

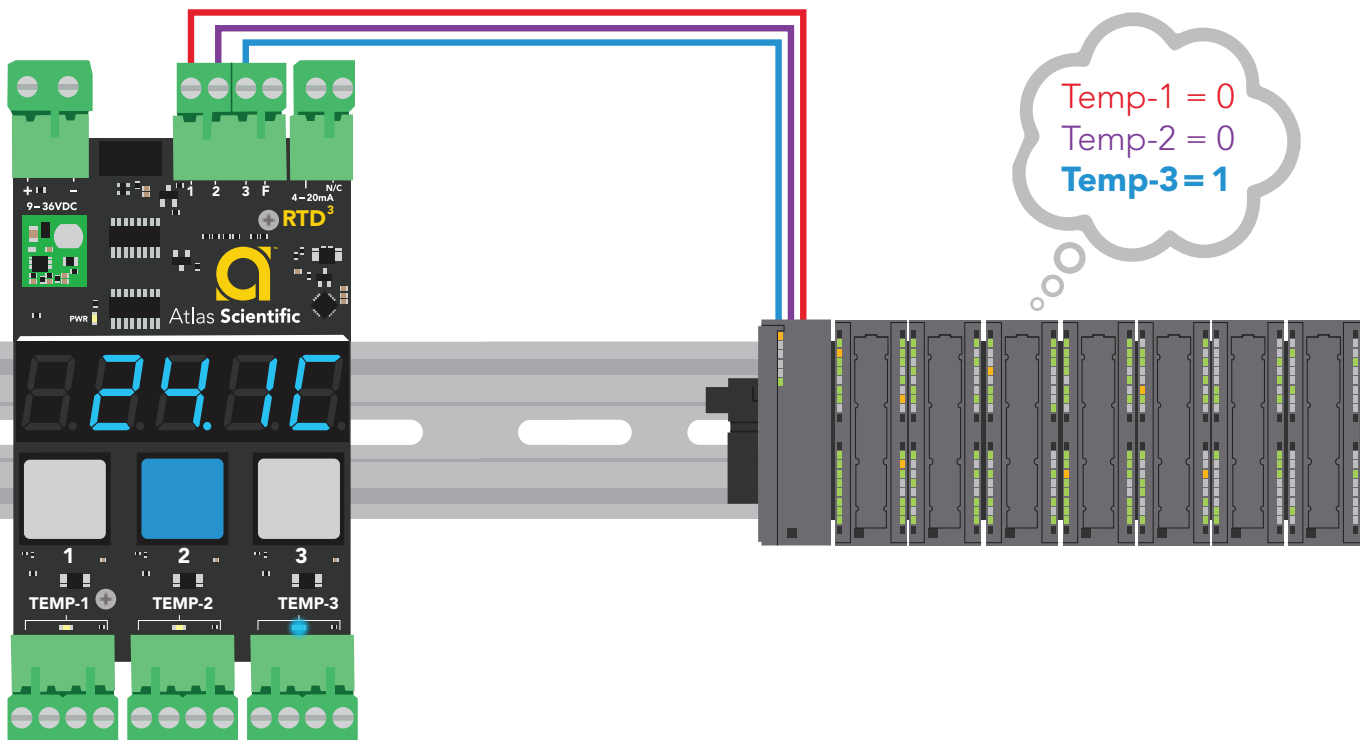

RTD³ is not able to tell the PLC which channel it is set to. You must use your channel switching code to keep track of which temperature sensor you are reading from.

Fault detect line

The connection marked "F" is the fault detect line. During normal operation the fault detect line will output a voltage equal to the voltage used to power the device. If the RTD³ Transmitter detects a problem the fault line will drop to 0 volts.

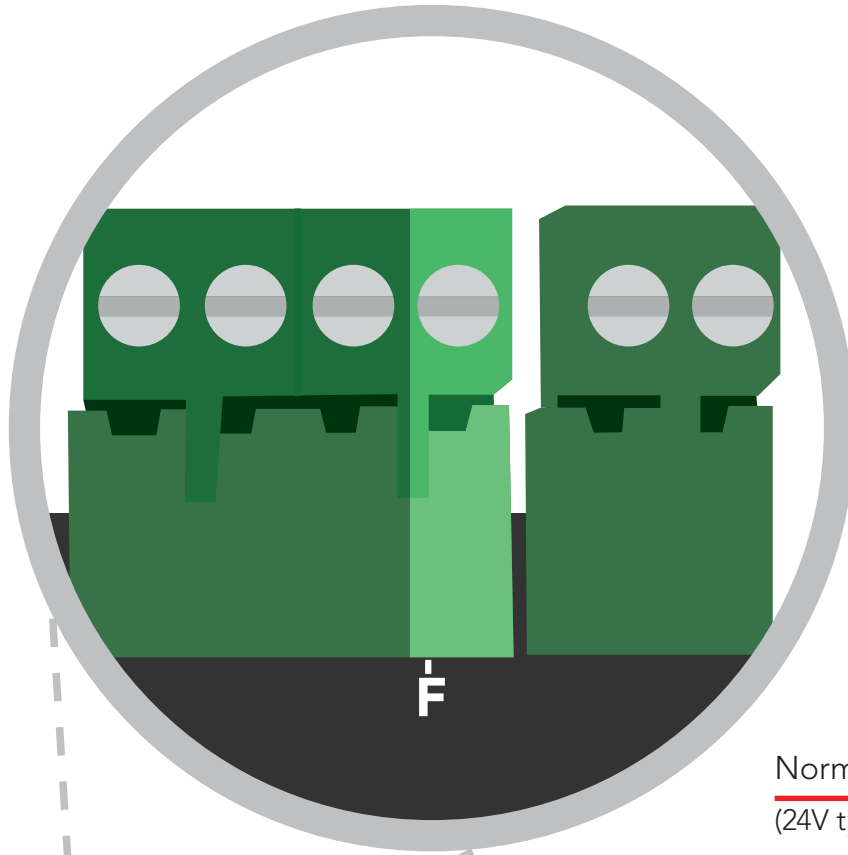

Normal operation

(24V typical)



Fault

0 Volts

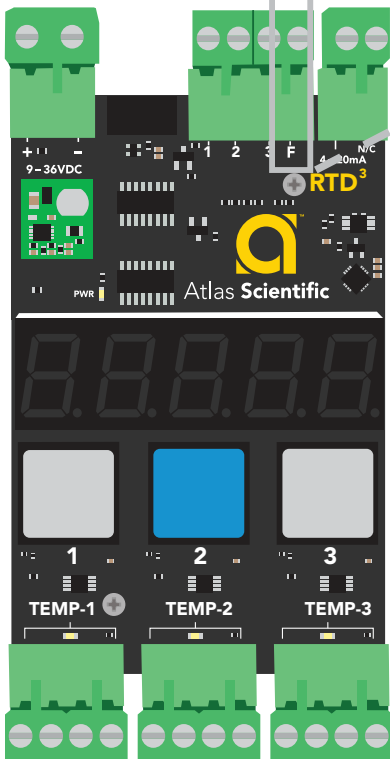

Example

The Industrial RTD Temperature Transmitter is powered with 24V, the "F" line will output 24V during normal operation.

Events that will trigger the fault line to go to 0 volts

- disconnected 4–20mA output.
- calibration in process.
- loss of power.

Connecting to the fault detect line is **optional**. Leaving it disconnected will have no effect on the RTD³ Industrial Temperature Transmitter's operation.

Calibration

To begin the calibration process, press and hold the button above the connected sensor for two seconds to issue the calibration command.

Once complete the LCD will display "CAL" for 2 seconds.

Calibration is done at 0°C.

Single point calibration is all that is needed to get accurate temperature readings over the full range of the probe. Atlas Scientific recommends putting all connected temperature sensor in an ice bath and calibrating them all at the same time.

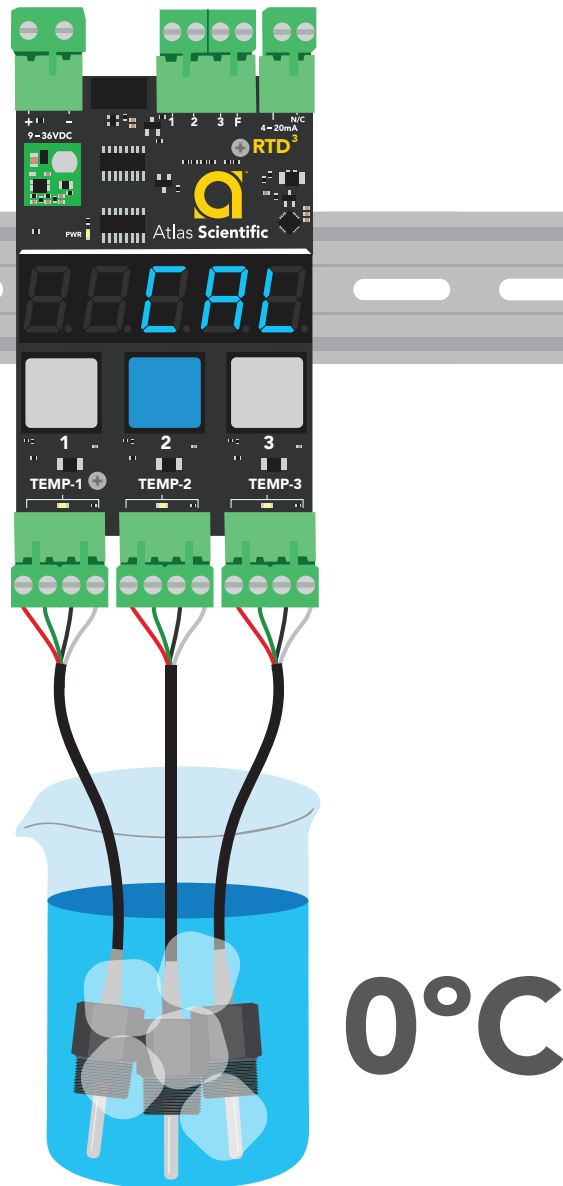

Calibration is stored to permanent memory and will not be lost if the power is cut.

Resetting calibration

Step 1

If needed, you can reset the calibration for each connected probe by holding down both the **2** and **3** buttons for three seconds.

The display will flash: `rESEt`



3 seconds

Step 2

Press and hold the **2** and **3** buttons again to confirm the reset.
To cancel, press the **1** button

Calibration reset complete!

Auto scrolling between channels

If you intend to use the RTD³ Transmitter without a PLC you have the ability to make it auto scroll between channels. This lets you see the temperature without having to manually press a button each time.

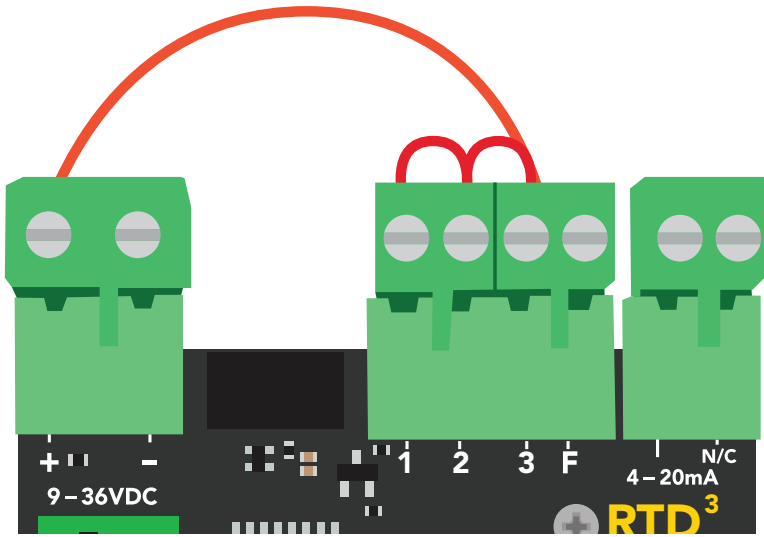

Shorting the PLC control pins to the input power will cause the readings to scroll every 2 seconds.

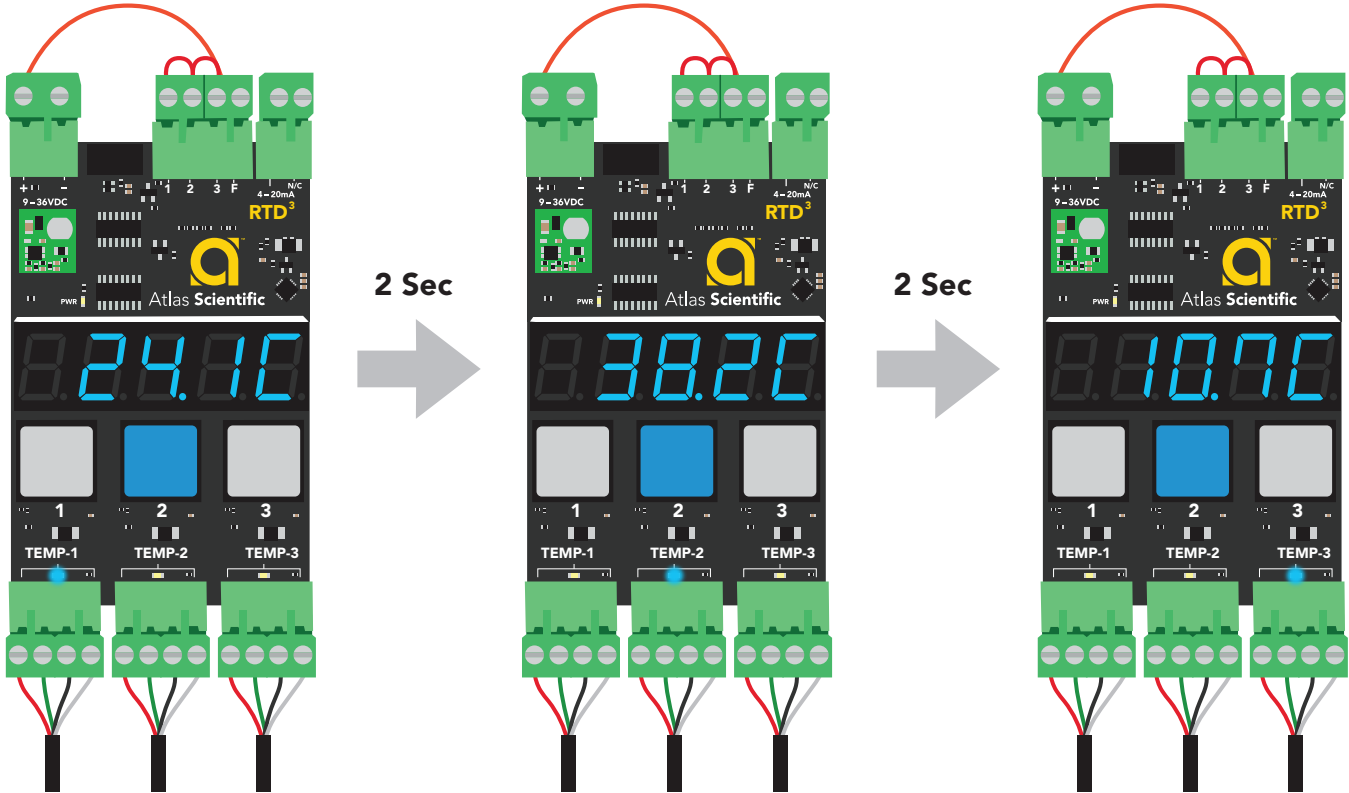

Datasheet change log

Datasheet V 1.1

Revised calibration reset information on page 18.

Datasheet V 1.0

New datasheet