

# Industrial pH Transmitter

**ISO 10523 Compliant**  
(determination of pH)

Reads	pH
Range	.001 – 14.000
Accuracy	+/- 0.002
Calibration	<b>1, 2, 3 point</b> remotely through PLC or directly on board
Supported probes	<b>Any type &amp; brand</b>
Temp probe	<b>PT-100 or PT-1000</b>
Auto temp compensation	<b>Yes</b>
Mount	<b>35mm Din rail</b>
Output	<b>4 – 20mA</b>
Operating voltage	<b>9VDC – 36VDC</b>
Electrically isolated	<b>Yes</b>

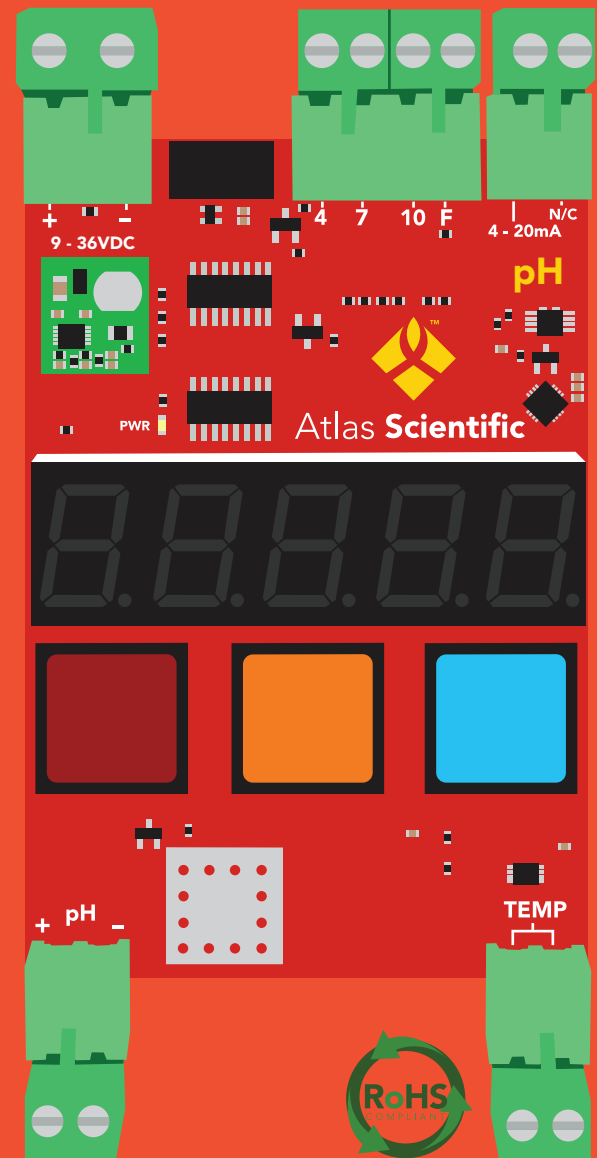

# Table of contents

<b>Transmitter dimensions</b>	<b>3</b>	<b>Power connection</b>	<b>7</b>
<b>Wiring diagram</b>	<b>4</b>	<b>pH connection</b>	<b>8</b>
<b>Operating principle</b>	<b>5</b>	<b>Temperature connection</b>	<b>9</b>
<b>Mounting</b>	<b>6</b>	<b>4–20mA connection</b>	<b>10</b>

<b>4–20mA pH transmission</b>	<b>11</b>
-------------------------------	-----------

<b>Reading 4–20mA output with a multimeter</b>	<b>12</b>
--	-----------

<b>PLC calibration node</b>	<b>13</b>
-----------------------------	-----------

<b>Fault detect line</b>	<b>14</b>
--------------------------	-----------

<b>Calibration theory</b>	<b>15</b>
---------------------------	-----------

<b>On-board calibration</b>	<b>16</b>
-----------------------------	-----------

<b>PLC calibration</b>	<b>17</b>
------------------------	-----------

<b>4–20mA calibration</b>	<b>18</b>
---------------------------	-----------

<b>4–20mA High</b>	<b>19</b>
--------------------	-----------

<b>4–20mA Low</b>	<b>20</b>
-------------------	-----------

<b>Temperature compensation</b>	<b>21</b>
---------------------------------	-----------

<b>Factory reset</b>	<b>22</b>
----------------------	-----------

<b>Datasheet change log</b>	<b>23</b>
-----------------------------	-----------

# Transmitter dimensions

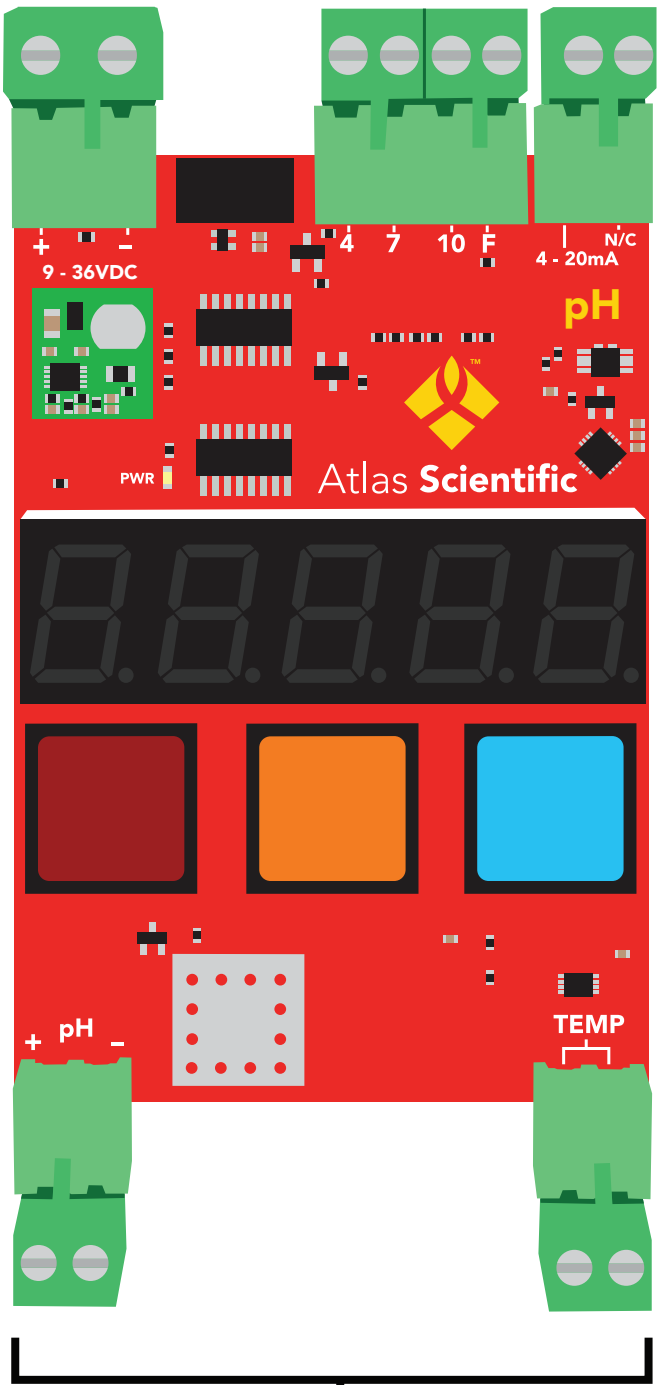

66.5mm  
(2.6")

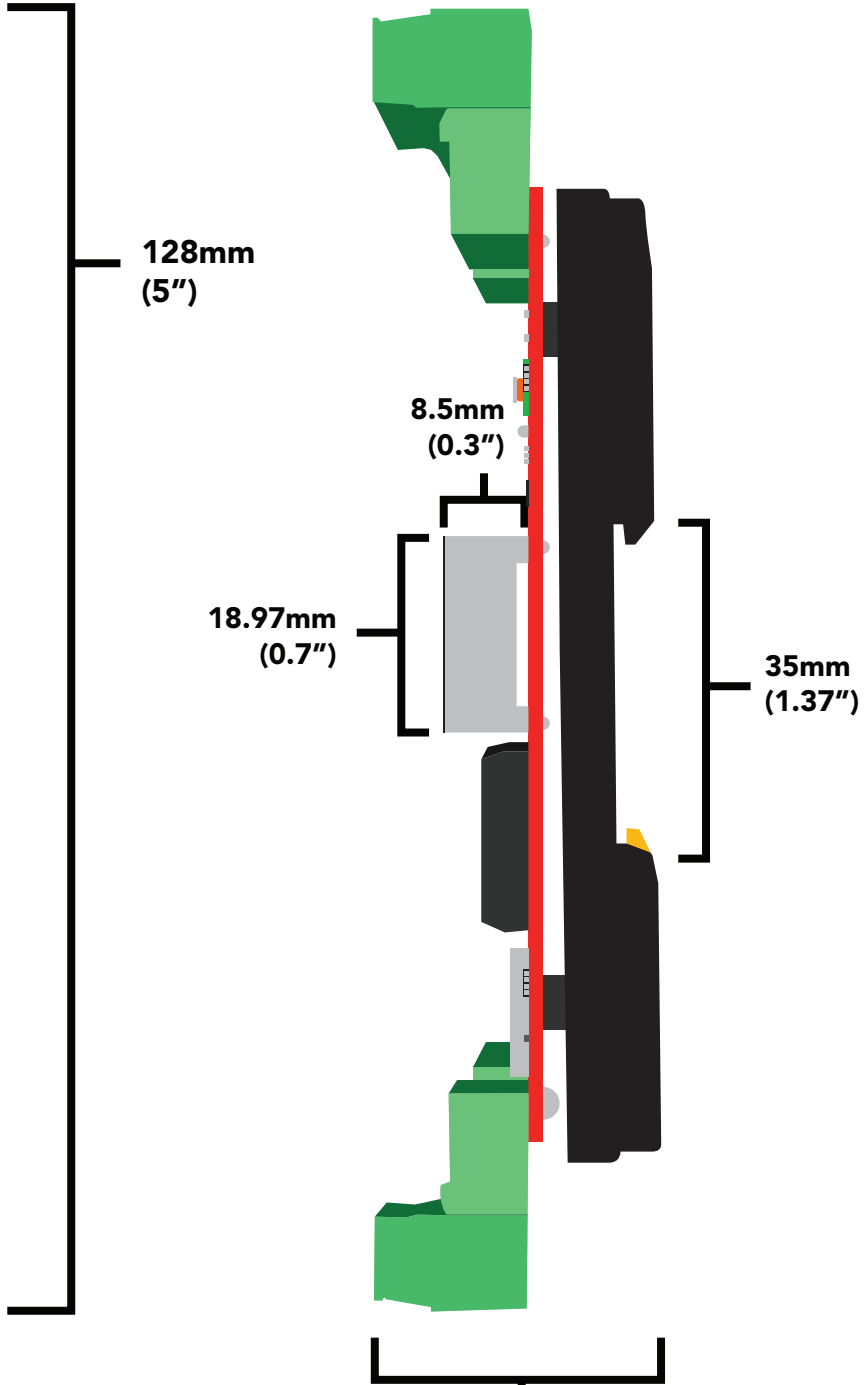

128mm  
(5")

8.5mm  
(0.3")

18.97mm  
(0.7")

35mm  
(1.37")

27.6mm  
(1.08")

# Wiring diagram

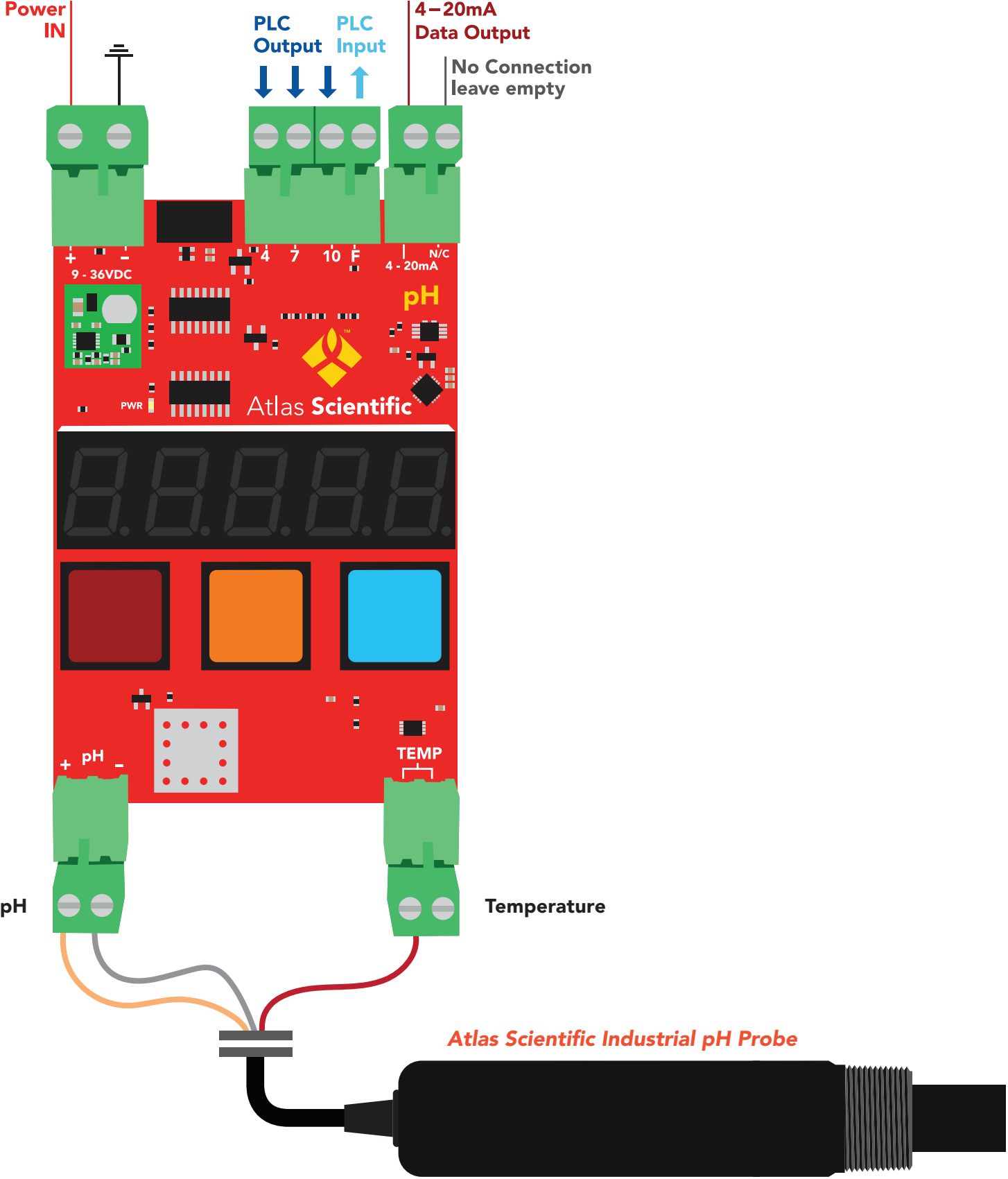

# Operating principle

A pH (**potential of Hydrogen**) probe measures the hydrogen ion activity in a liquid. At the tip of a pH probe is a glass membrane. This glass membrane permits hydrogen ions from the liquid being measured to diffuse into the outer layer of the glass, while larger ions remain in the solution. The difference in the concentration of hydrogen ions (outside the probe vs. inside the probe) creates a VERY small current. This current is proportional to the concentration of hydrogen ions in the liquid being measured.

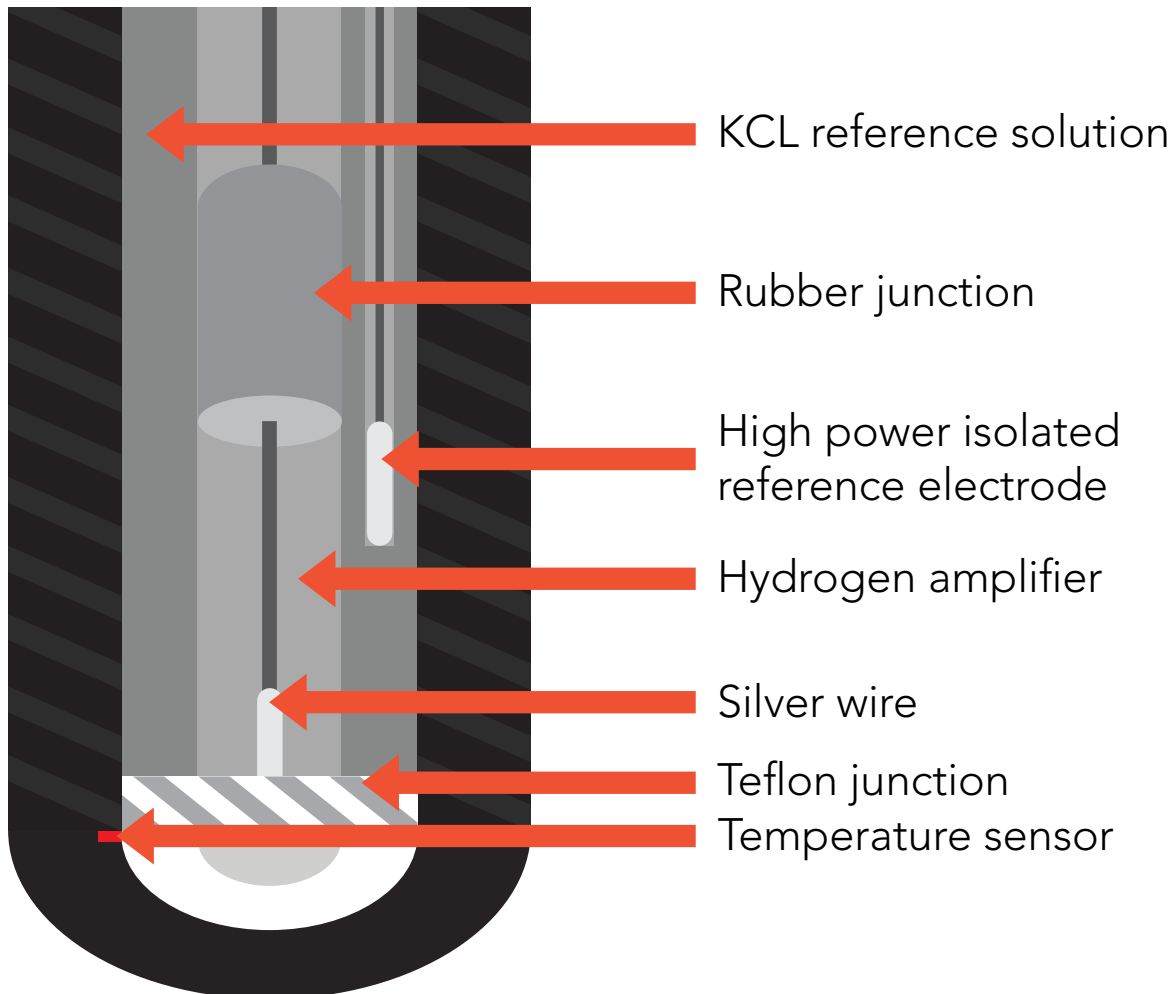
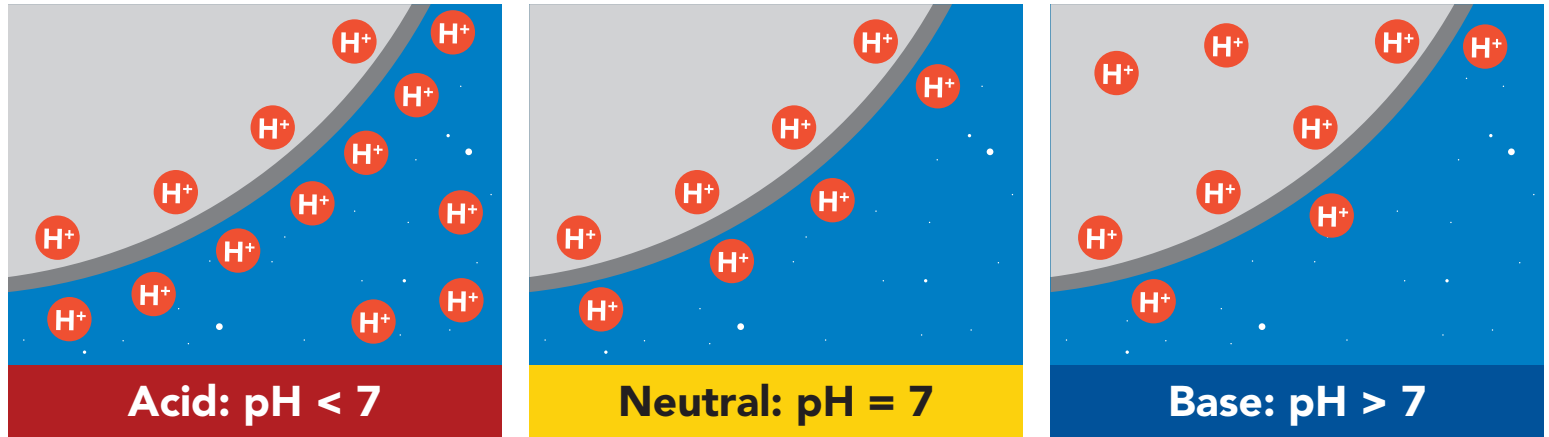



# Power connection

Any DC voltage from 9V – 36V can be used to power the Industrial pH Transmitter. The power connector is keyed differently and is larger than the other connectors.

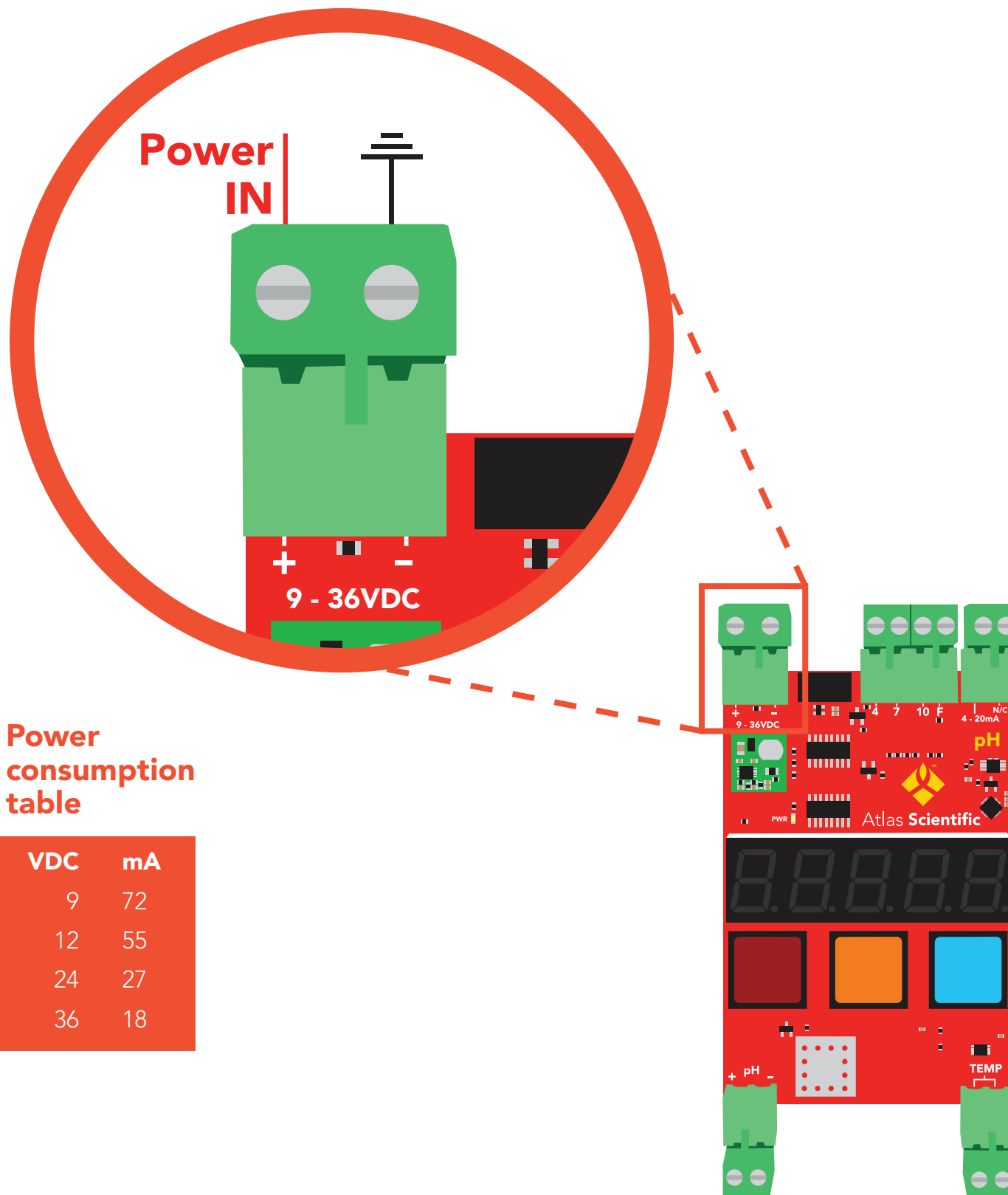

## Power consumption table

VDC	mA
9	72
12	55
24	27
36	18

# pH connection

Any off the shelf two wire pH probe can be used with the Industrial pH Transmitter.

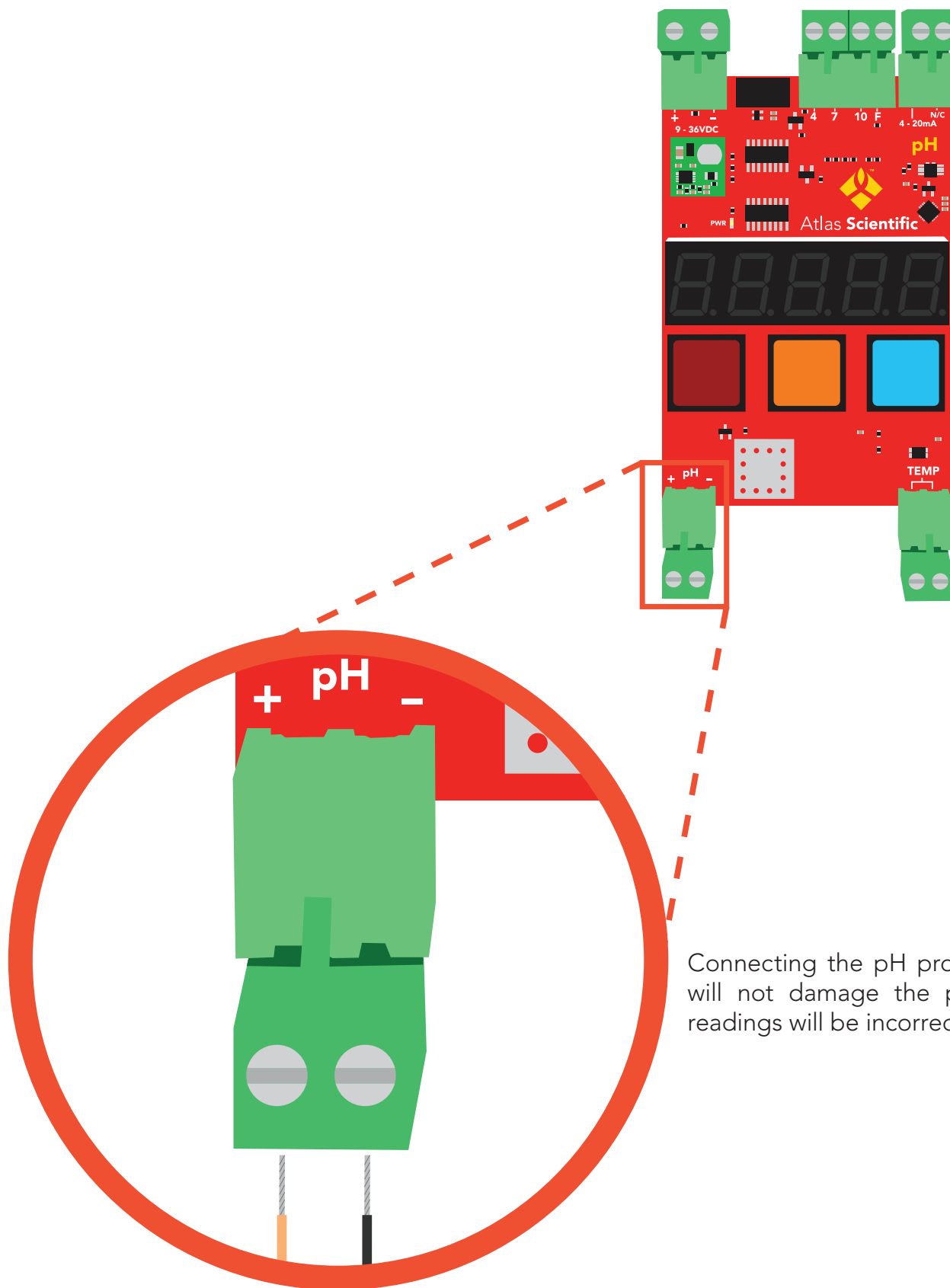

Connecting the pH probe in reverse order will not damage the probe however, the readings will be incorrect.



# Temperature connection

A PT-100 or PT-1000 temperature probe can be connected to the Industrial pH Transmitter.

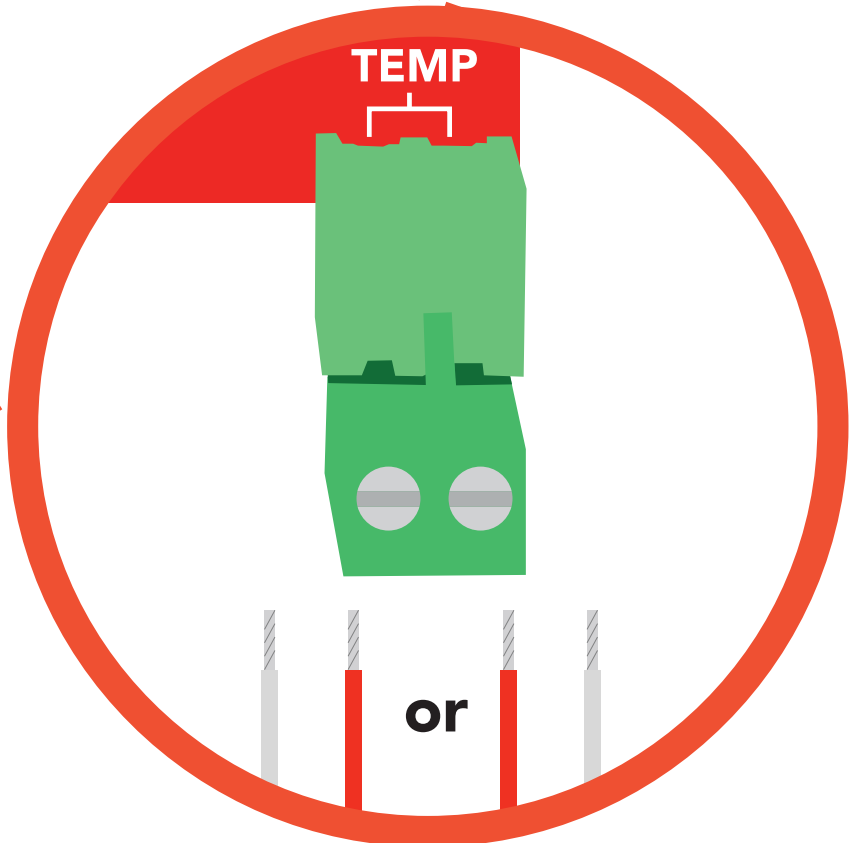
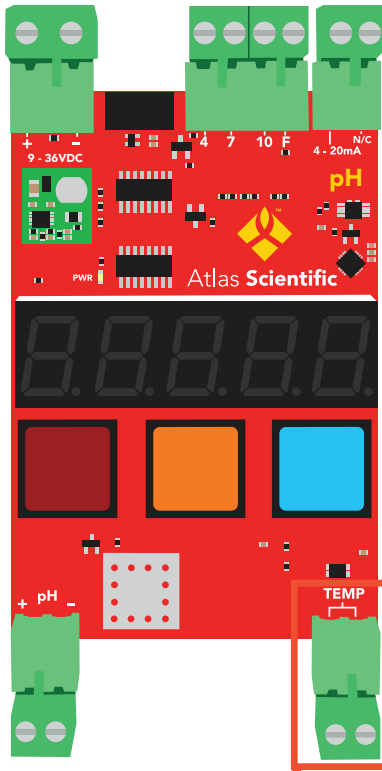

Either method of wiring will produce the same result. ***There is no polarity.***

# 4–20mA connection

Connecting the 4–20mA data output to your PLC, allows the Industrial pH Transmitter to communicate with your PLC.

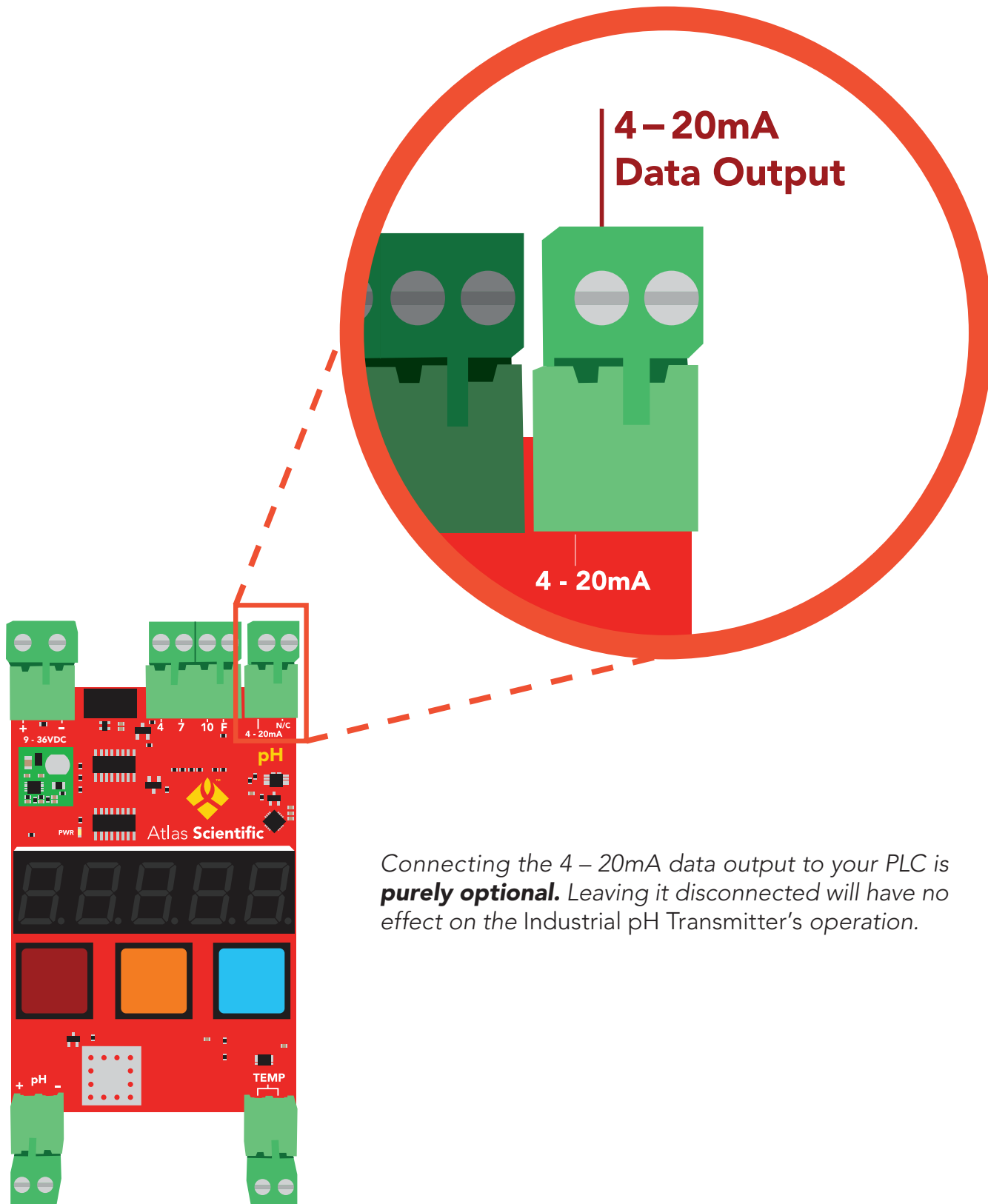

Connecting the 4 – 20mA data output to your PLC is **purely optional**. Leaving it disconnected will have no effect on the Industrial pH Transmitter's operation.

# 4 – 20mA pH transmission

The pH value that is visible on the seven segment LED screen is also, simultaneously transmitted through the 4 – 20mA data output.

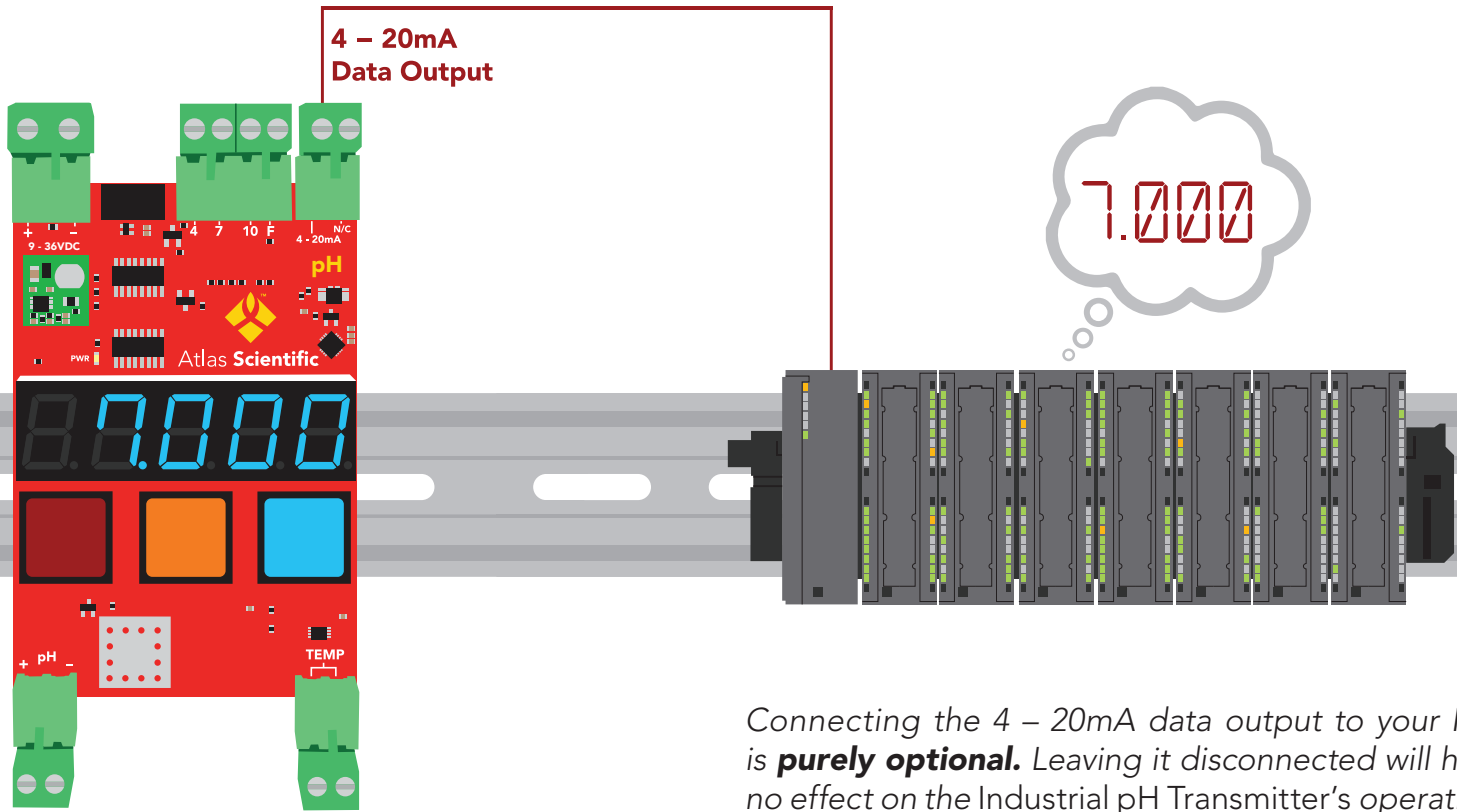

Connecting the 4 – 20mA data output to your PLC is **purely optional**. Leaving it disconnected will have no effect on the Industrial pH Transmitter's operation.

## pH to 4–20mA equation

$$\left(\frac{pH}{14} * 16\right) + 4 = mA$$

## Advanced

### 4 – 20mA max load resistance

$$R_{max} = \frac{(V_{in} - 1)}{0.026}$$

R = the total resistive load on the line.  
V = the voltage powering the transmitter.

pH	mA	pH	mA
0.00	4.00	8.00	13.14
1.00	5.14	9.00	14.28
2.00	6.28	10.00	15.42
3.00	7.42	11.00	16.57
4.00	8.57	12.00	17.71
5.00	9.71	13.00	18.85
6.00	10.85	14.00	20.00
7.00	12.00		

## PLC ADC Resolution

10 BIT = 0.015 pH units  
16 BIT = 0.003 pH units

# Reading 4–20mA output with a multimeter

To debug the Industrial pH Transmitter output, first connect it to a multimeter as shown. (make sure the multimeter is set to "mA"). Once properly connected, set the Industrial pH Transmitter to calibrate to either 4.00, 7.00, or 10.00. Compare the reading on the multimeter to the chart below.

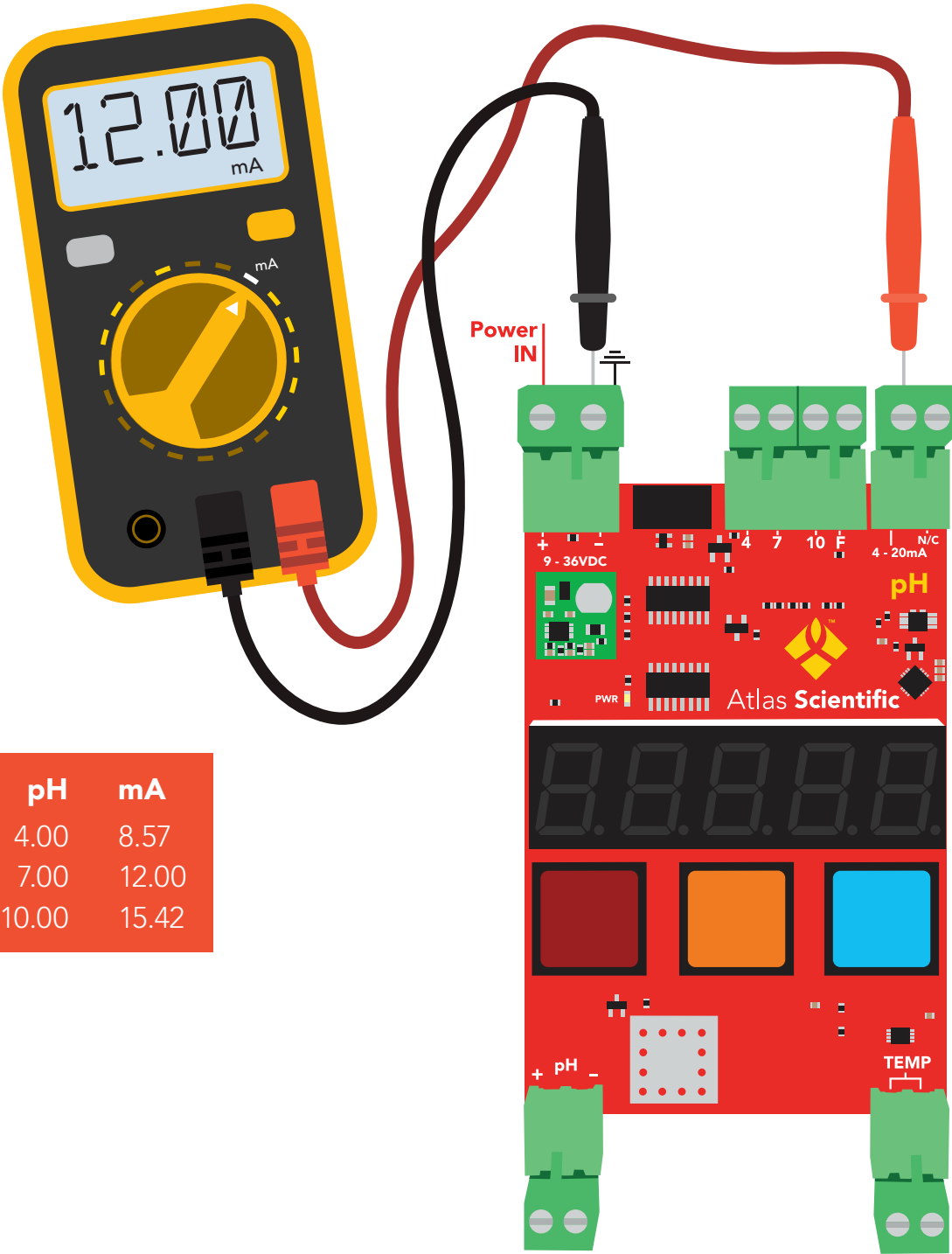

pH	mA
4.00	8.57
7.00	12.00
10.00	15.42

# PLC calibration node

Using the three input connections marked "4", "7", "10" it's possible to use a PLC to fully calibrate the Industrial pH Transmitter. This is particularly beneficial when using a PLC touch screen.

Sending an output signal from the PLC to the pH Transmitters 4, 7, or 10 input connection will calibrate the device.

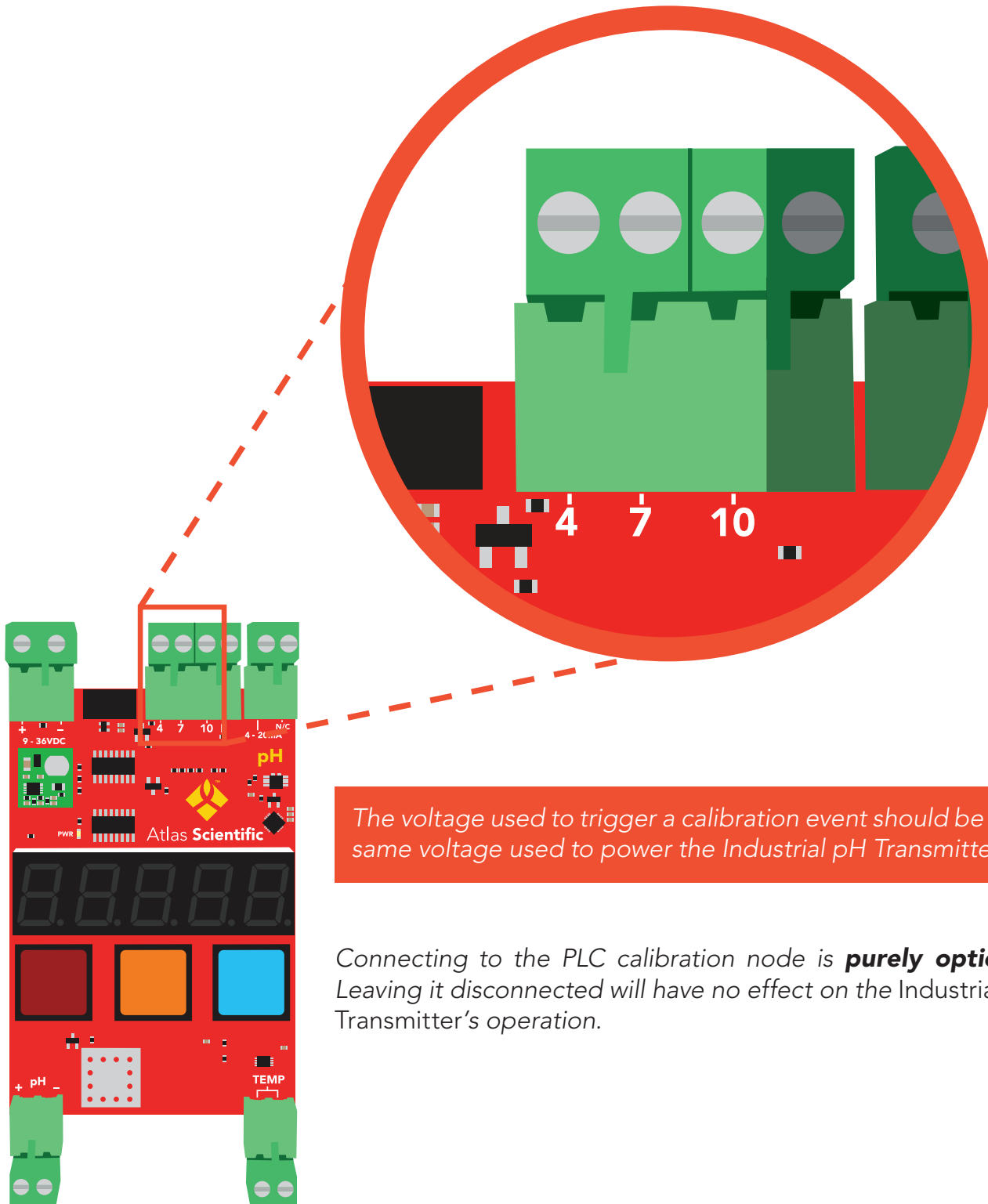

*The voltage used to trigger a calibration event should be the same voltage used to power the Industrial pH Transmitter.*

*Connecting to the PLC calibration node is **purely optional**. Leaving it disconnected will have no effect on the Industrial pH Transmitter's operation.*

# Fault detect line

The connection marked "F" is the fault detect line. During normal operation the fault detect line will output a voltage equal to the voltage used to power the device. If the *Industrial pH Transmitter* detects a problem the fault line will drop to 0 volts.

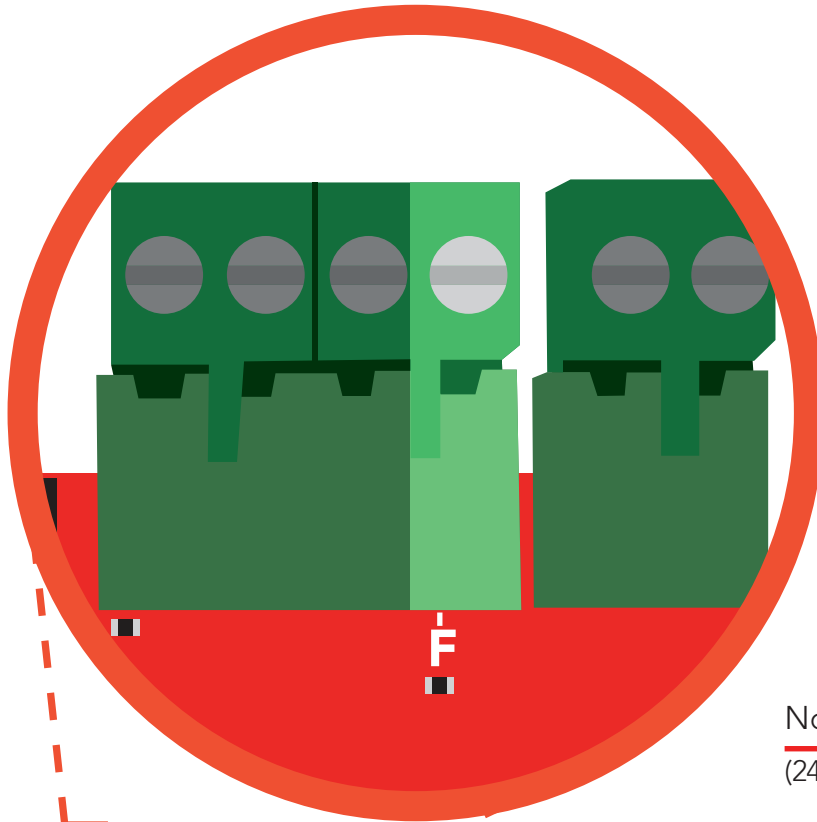

Normal operation  
(24V typical)



**Fault** 0 Volts

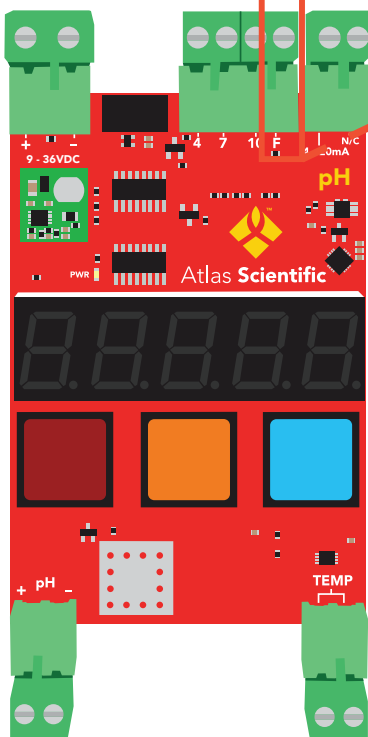

## Example

The Industrial pH Transmitter is powered with 24V the "F" line will output 24V during normal operation.

## Events that will trigger the fault line to go to 0 volts

- pH probe reporting a pH less than 0 or greater than 14.
- disconnected 4–20mA output.
- calibration in process.
- loss of power.

Connecting to the fault detect line is **purely optional**. Leaving it disconnected will have no effect on the Industrial pH Transmitter's operation.

# Calibration theory

The Atlas Scientific Industrial pH Transmitter has a flexible calibration protocol, allowing for **single point**, **two point**, or **three point** calibration. **The calibration data is stored in the EEPROM, and will be retained even if the Transmitter is powered off.**

The calibration values are **4.00**, **7.00**, and **10.00**.

## The first calibration point must be pH 7.00

Calibrating to pH 7.00 will reset the stored calibration. If two, or three point calibration has been done in the past, it must now be redone.

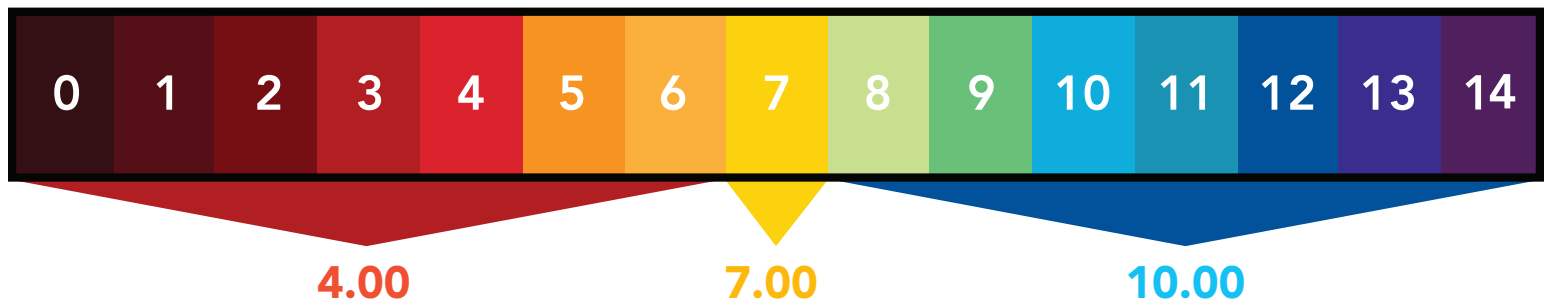

There is no correct order when calibrating to **4.00** and/or **10.00**. Recalibrating these two points will not have any effect on the other stored calibration points. Calibrating the Industrial pH Transmitter to **4.00** and/or **10.00** can be done at any time.

### No calibration



### Single point calibration

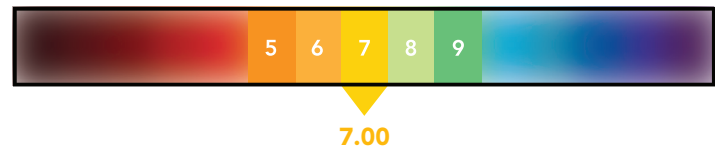

### Two point calibration

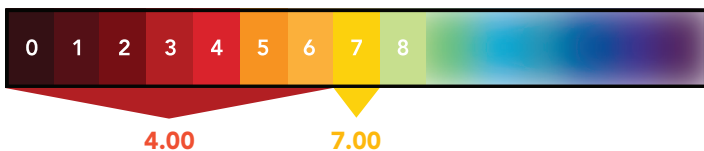

### Three point calibration

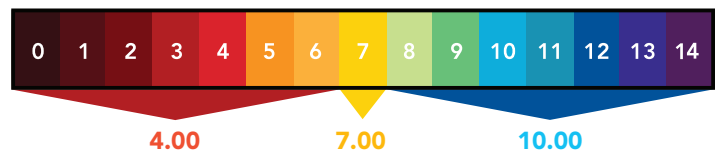

Two point calibration will provide high accuracy between **7.00** and the second point calibrated against, such as a **4.00**.

Three point calibration will provide high accuracy over the full pH range. Three point calibration at **4.00**, **7.00** and **10.00** should be considered the standard.

# On-board calibration

To begin the on-board calibration process, press and hold the middle **orange** button for 1.5 seconds to calibrate to a pH of **7.00**.

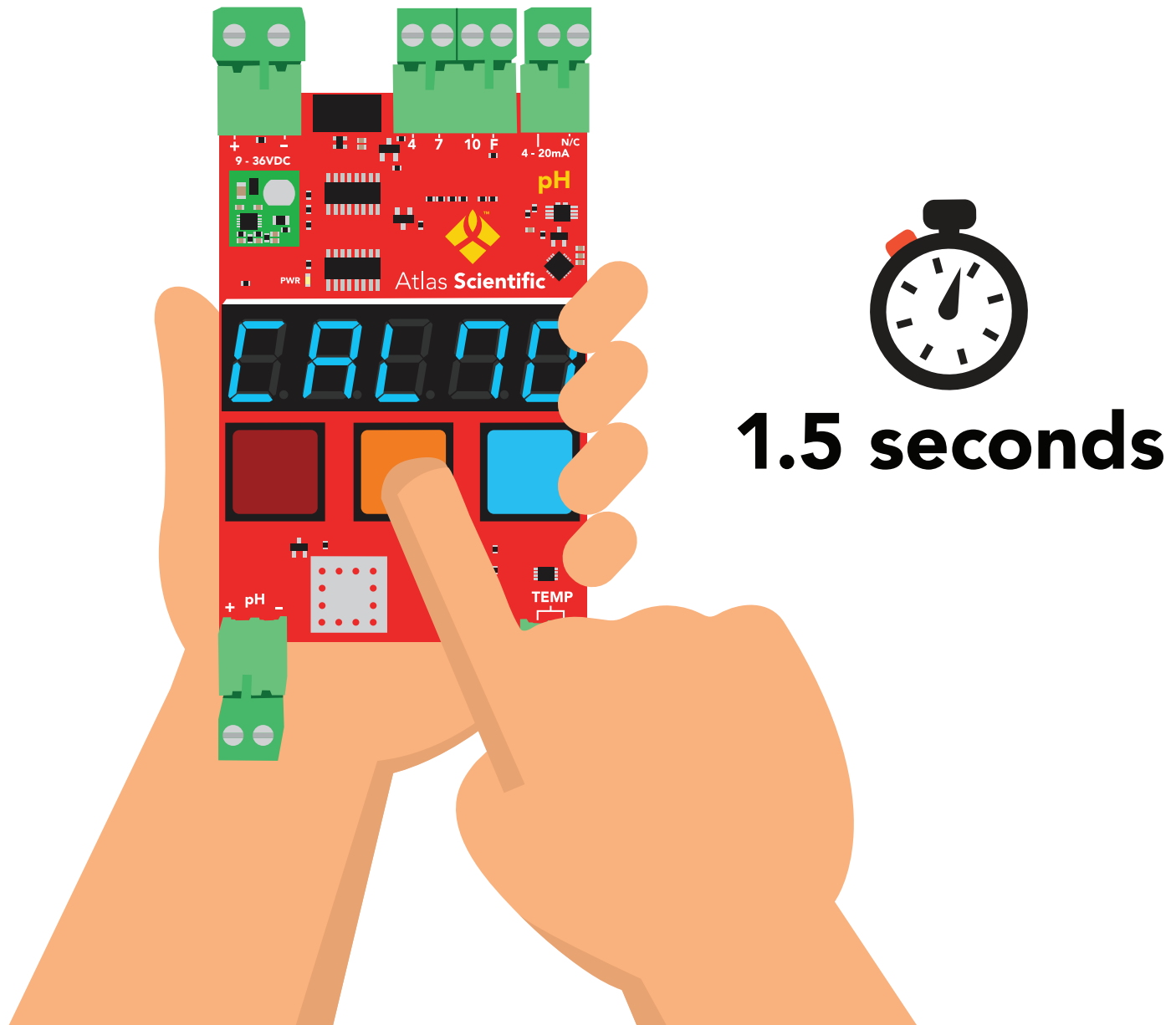

## The first calibration point must be pH 7.00

Calibrating to pH 7.00 will reset the stored calibration. If two, or three point calibration has been done in the past, it must now be redone.

The display will flash: *CAL 7.0*, after a few seconds the display will then flash: *done*

If two point or three point calibration is required, repeat this process to calibrate for pH **4.00** (left **red** button) and pH **10.00** (right **blue** button).



# PLC calibration

Using the three input connections marked "4", "7", "10" it's possible to use a PLC to fully calibrate the Industrial pH Transmitter. Setting the PLC's output to 200ms or more will trigger a calibration event.

This is particularly beneficial when using a PLC touch screen.



The voltage used to trigger a calibration event should be the same voltage used to power the Industrial pH Transmitter.

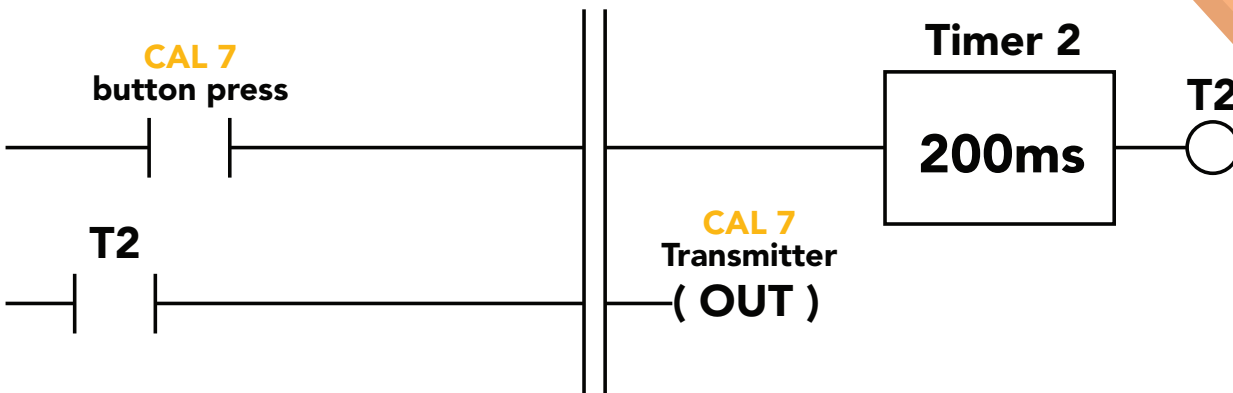

A calibration event will only trigger if the corresponding input pin has been held high for 200ms. *Holding the line for more than 200ms will have no effect.*

## The first calibration point must be pH 7.00

Calibrating to pH 7.00 will reset the stored calibration. If two, or three point calibration has been done in the past, it must now be redone.

# 4 – 20mA calibration

To ensure that the PLC is receiving the most accurate 4 – 20mA signal, the current output from the Industrial pH Transmitter can be adjusted. The 4mA signal and the 20mA signal can both be adjusted independently.

To enter the 4 – 20mA calibration mode press and hold the **red** and **blue** buttons simultaneously for 1.5 seconds.

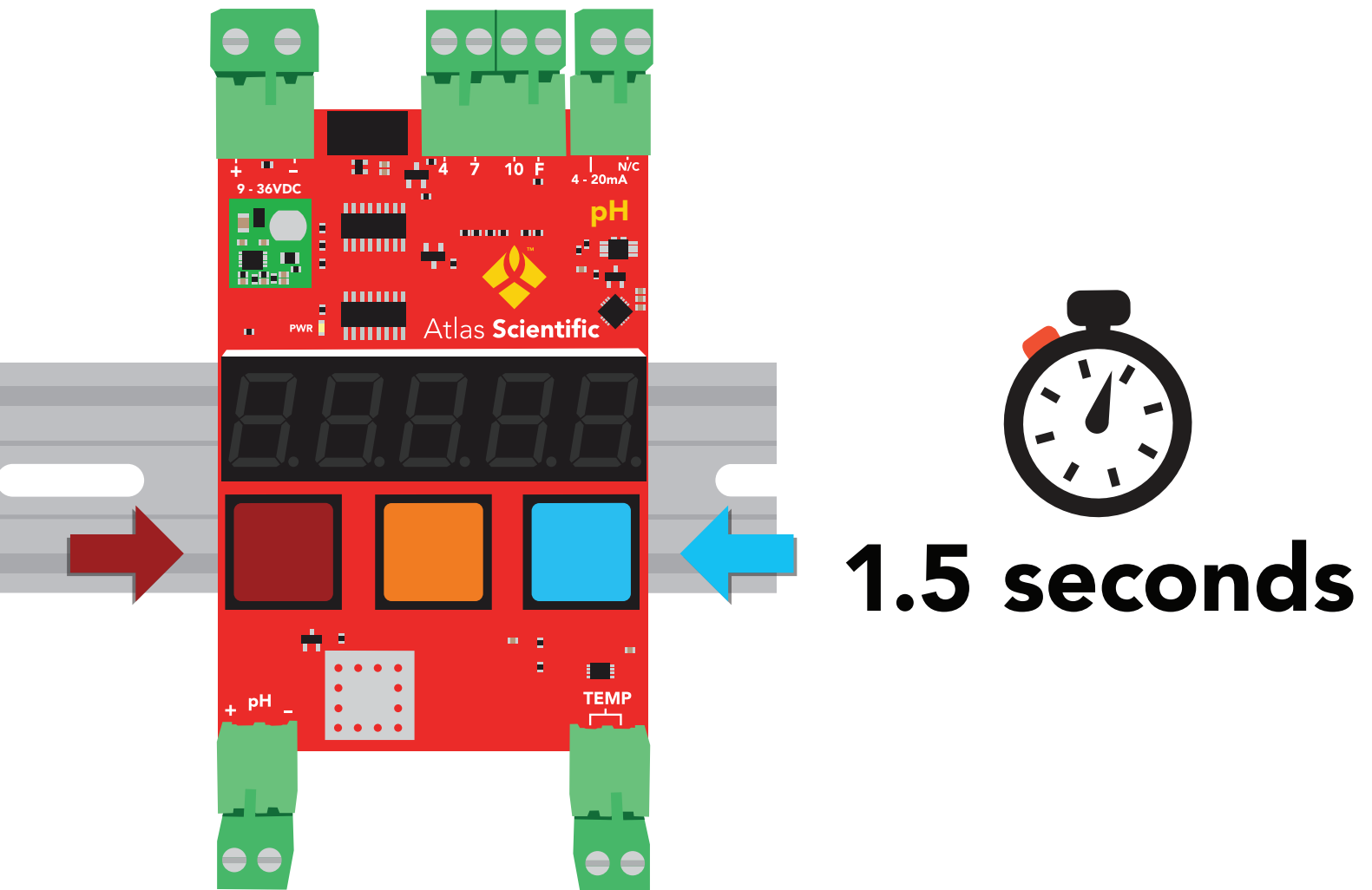

# 4 – 20mA High

The display will flash: **4-20H** (the “H” stands for high) The Industrial pH Transmitter will now output exactly 20mA, and your PLC should show a pH of 14.000. Use the **orange (up)** and **blue (down)** buttons to adjust the 20mA output so the pH moves to 13.999, then move it back up, so it is just hits pH 14. When you have finished making adjustments, press the **red (save)** button to confirm.

The 20mA offset will be permanently stored in memory.

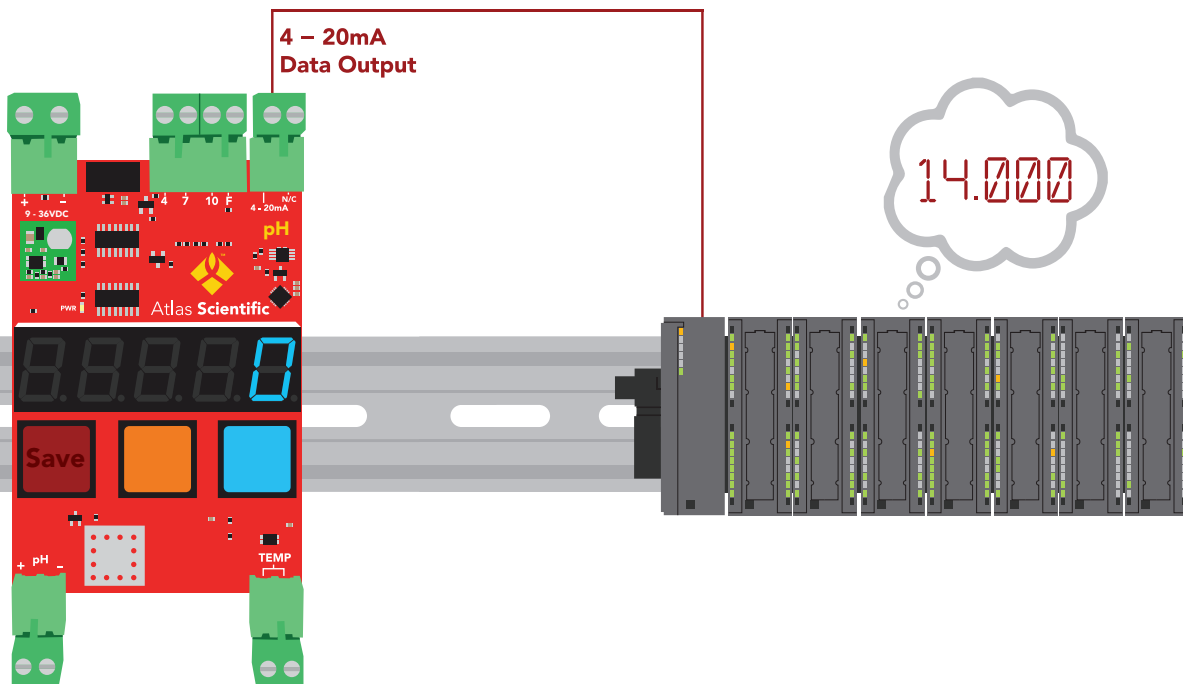
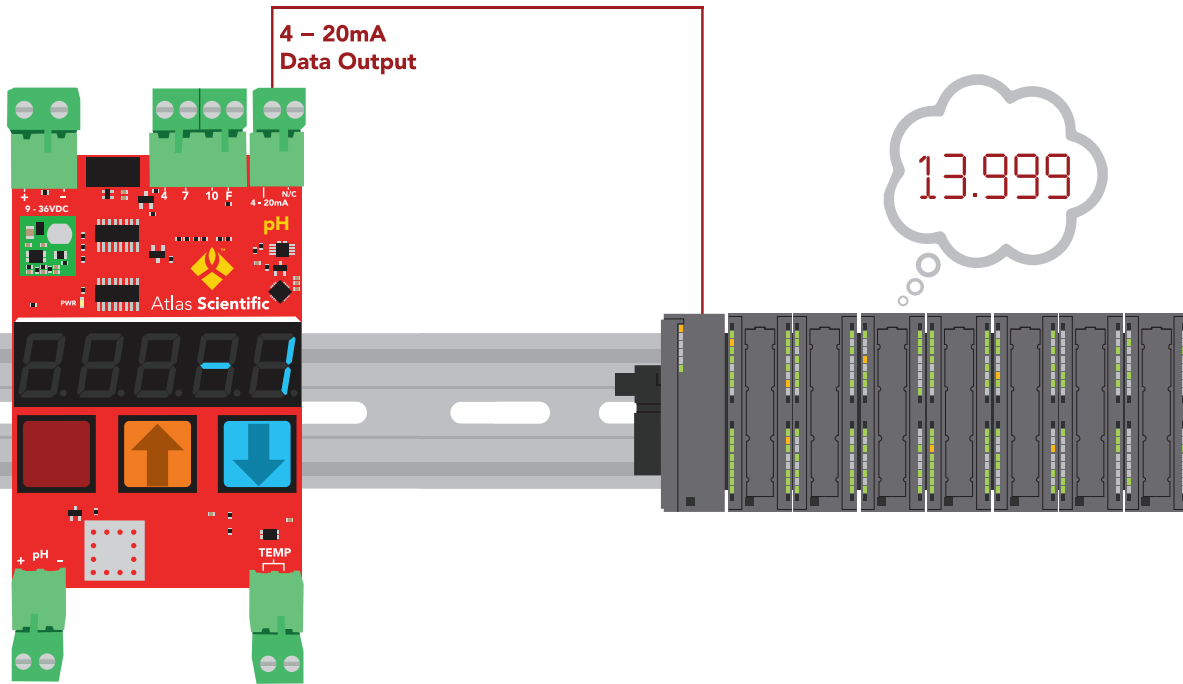

# 4 – 20mA Low

The display will flash: **4-20L** (the "L" stands for low) The Industrial pH Transmitter will now output exactly 4mA, and your PLC should show a pH of 0.000 Use the **orange (up)** and **blue (down)** buttons to adjust the 4mA output so the pH moves to -0.001, then move it back up, so it is just hits pH 0.000 When you have finished making adjustments, press the **red (save)** button to confirm.

The 4mA offset will be permanently stored in memory.

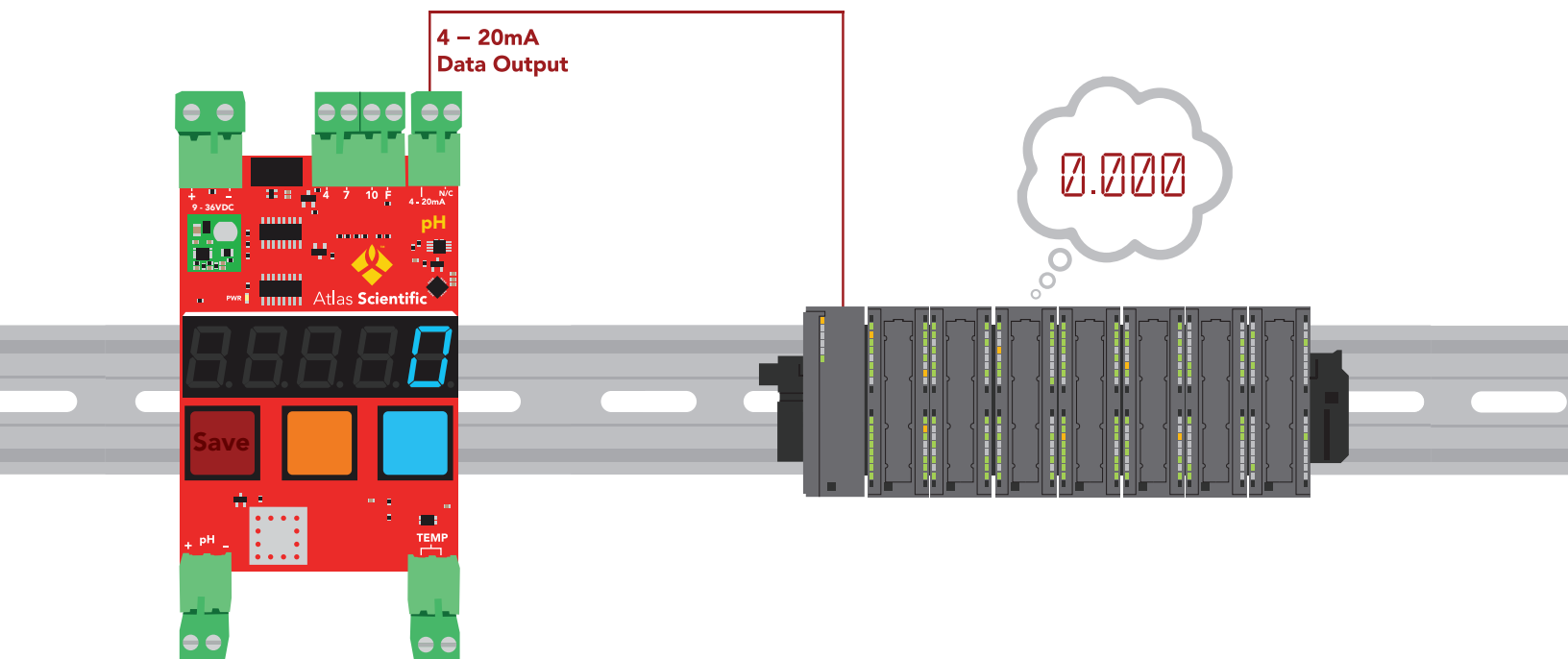
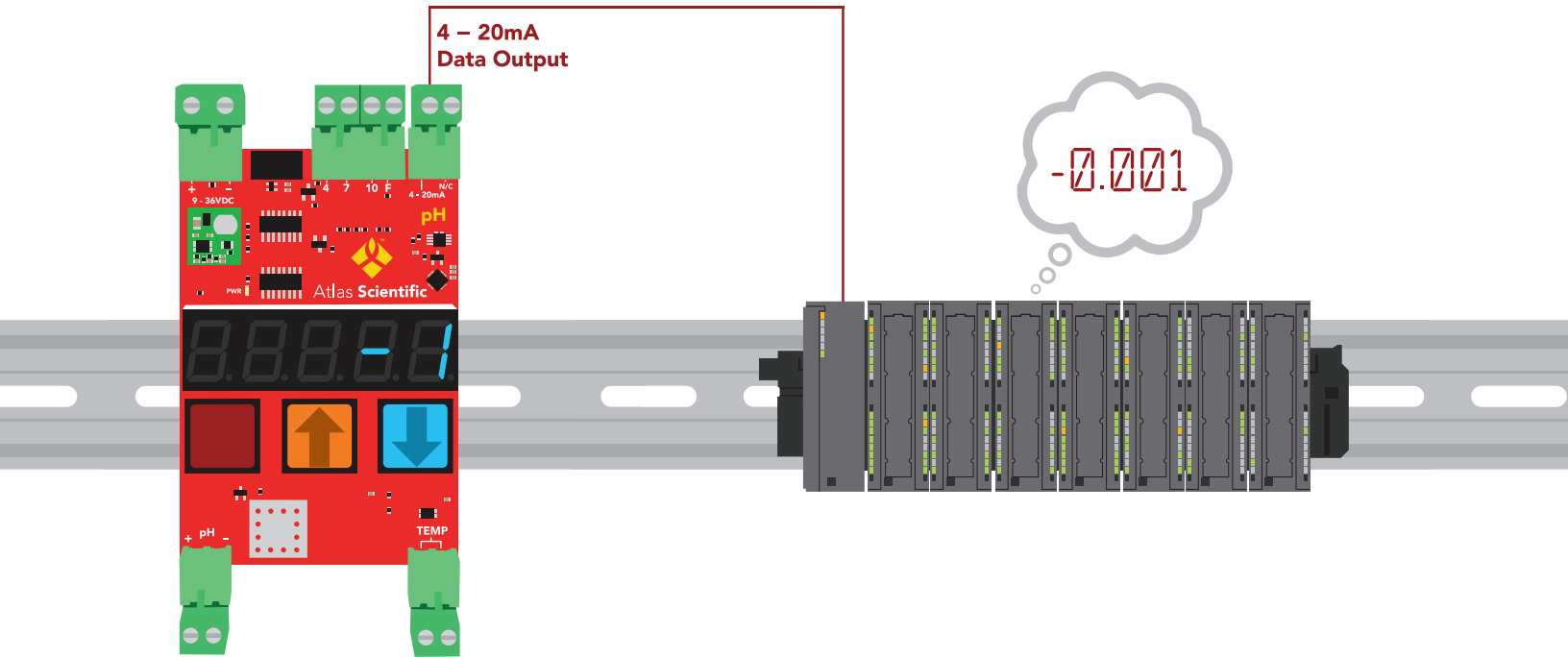

# Temperature compensation

To view the temperature from the attached PT-100, or PT-1000 temperature probe, press the **red** and **orange** buttons simultaneously. The Industrial pH Transmitter will continue to display the temperature for 10 seconds, or until the **red** and **orange** buttons are pressed again.

If a temperature probe is not connected, The Industrial pH Transmitter will use 25°C as the default temperature.

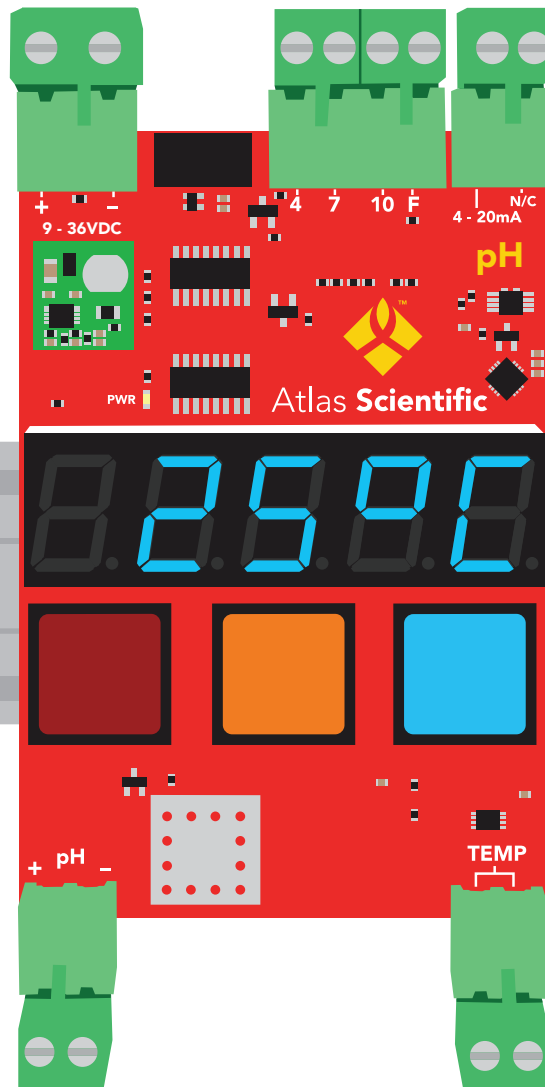

Temperature data cannot be output to PLC.

# Factory reset

## Step 1

The Industrial pH Transmitter can be reset to its default settings. To issue a factory reset, press and hold the **orange** and **blue** buttons for three seconds.

The display will flash: `rESEt`

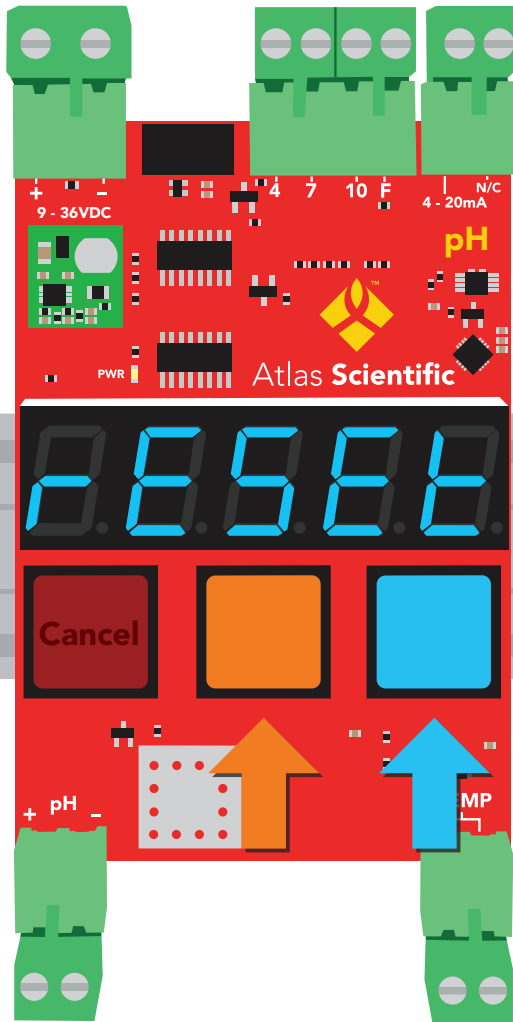

**3 seconds**

## Step 2

Press and hold the **orange** and **blue** buttons again to confirm the factory reset. To cancel a factory reset, press the **red** button.

**Factory reset complete!**

# Datasheet change log

## **Datasheet V 3.9**

Revised factory reset information on page 22.

## **Datasheet V 3.8**

Revised art to reflect V2.4 changes.

## **Datasheet V 3.7**

Revised art to show Gen 2 Industrial pH Probe.

## **Datasheet V 3.6**

Revised art throughout datasheet.

## **Datasheet V 3.5**

Corrected typo on pg 20.

## **Datasheet V 3.4**

Revised information on pages 19 & 20.

## **Datasheet V 3.3**

Added 4 – 20mA max load resistance formula on pg 11.

## **Datasheet V 3.2**

Revised art to reflect V2.3 changes.

## **Datasheet V 3.1**

Added info about calibration data saved to EEPROM on pg 15.

## **Datasheet V 3.0**

Revised entire datasheet.