

REVISION HISTORY

REV.	DESCRIPTION	DATE	DRAWN BY
1	ORIGINAL PRINT	2/26/2021	N. LAWRENCE

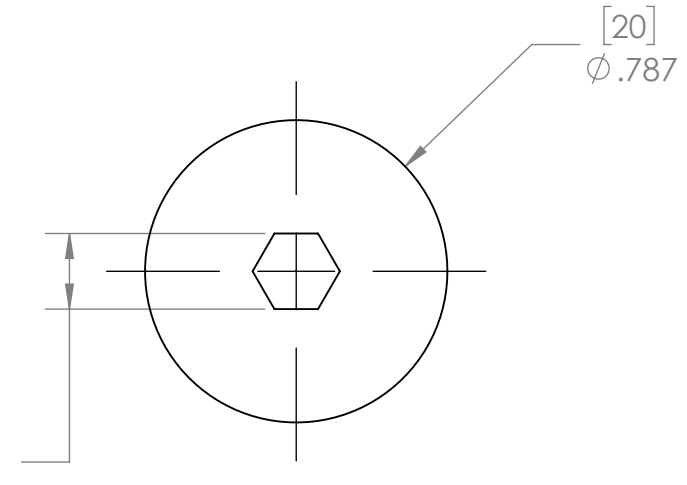
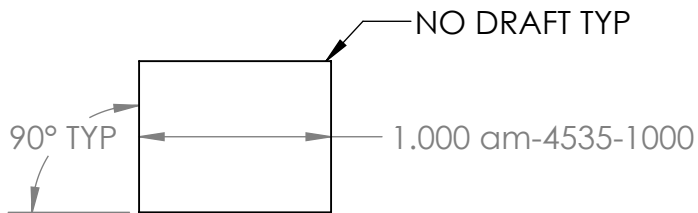
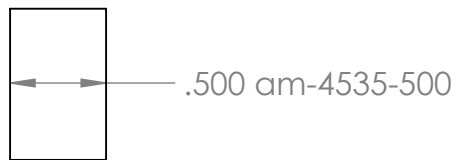
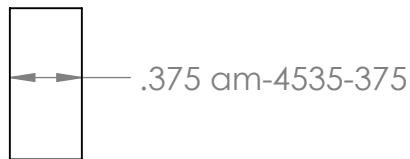
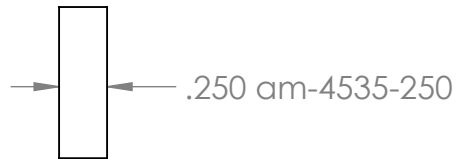
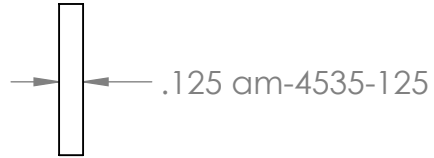
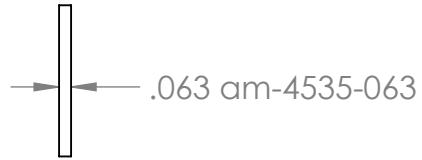

HEX THRU
NO DRAFT

*** SEE CAD FOR ADDITIONAL TOOLPATH INFO***

UNLESS OTHERWISE SPECIFIED:		COMMENTS:					
DIMENSIONS ARE IN INCHES		DUAL DIMENSIONS ARE IN MILLIMETERS.					TITLE: 5mm HEX MOLDED SPACERS LAYOUT
TOLERANCES: FRACTIONAL ±1/16 ANGULAR: MACH ±1° ANGULAR: BEND ±5° ONE PLACE DECIMAL ±0.1 TWO PLACE DECIMAL ±0.01 THREE PLACE DECIMAL ±0.005 FOUR PLACE DECIMAL ±0.0005		BREAK ALL SHARP EDGES.		SIZE	DWG. NO.	REV	
MATERIAL		CHECKED	NAME	DATE	A	am-4535	1
BLACK PC		ENG APPR.	NM	2/26/21			
FINISH		MFG APPR.					
DEBURRED		Q.A.					
DO NOT SCALE DRAWING				SCALE: 2:1		SHEET 1 OF 1	