



PB-01/02-KIT Specifications

Version V1.0

Copyright ©2020

Disclaimer and copyright notice

The information in this article, including the URL address for reference, is subject to change without notice. The Documentation is provided "as is" without any warranty, including any warranties of merchantability, fitness for a particular purpose, or non-infringement, and any warranties mentioned in the proposal, specification or sample. This document is not responsible for any infringement of any patent rights arising out of the use of the information in this document. No license, express or implied, by estoppel or otherwise, is hereby granted.

The test data obtained in this paper are all obtained by Ai-Thinker laboratory , and the actual results may be slightly different. The Wi-Fi alliance membership mark is owned by the WiFi alliance.

All trade mark names, trademarks and registered trademarks mentioned herein are the property of their respective owners and are hereby declared.

The final interpretation right is owned by Shenzhen Ai-Thinker Technology Co., Ltd.

Note

The contents of this manual may be changed due to the version upgrade of the product or other reasons. Shenzhen Ai-Thinker Technology Co., Ltd. reserves the right to modify the contents of this manual without any notice. This manual is only used as a guide, and Shenzhen Ai-Thinker Technology Co., Ltd. makes every effort to provide accurate information in this manual, but Shenzhen Ai-Thinker Technology Co., Ltd. does not ensure that the contents of the manual are completely true. All statements and information in this manual, and the recommendations do not constitute for any warranty, express or implied.

Revision History

Version	Date	Development/revision	Development	Approval
V1.0	2020.10.23	Official release	Junx	XuH
V1.1	2020.12.07	Document updates	XuH	XuH

1. Product Overview

PB-01/02-Kit development board is an intelligent lighting development board designed for PB-01/02 modules. It needs external antenna with IPEX seat, PB-02 with its own pcb antenna. There are six PWM, which can be adjusted by itself RGB colorful lamp and two cold and warm lamp beads. All modules can be used to lead out by pin header , convenient for developers to develop and debug;

The integration of rich information, including AT commands, SDK secondary development, support Bluetooth mesh network configure, as well as Android / IOS APP control and WeChat Mini Program control, but also support Tmall genie voice direct connection control; multiple development boards interconnected, can be used to Mesh networking debugging ,2.54 mm pin header to lead out all GPIO/PWM/SPI/ADC interfaces, free to match peripherals.

UART interface supports firmware burning, Keil5 software development, simple and fast.

Characteristics

- Module : PB-01/02
- BLE5.0, support Mesh
- Interface Type: Standard micro USB+ 2.54mm Spacing Pin header
- PWM/SPI/GPIO/ADC interface
- own R/G/B triads and cold/warm beads
- own reset button and 1 user-defined key
- support Tmall Genie Voice Configure, Android / IOS APP Control and WeChat Mini Program Control

Main parameters

Table 1 Main parameters description

Model	PB-01/02-KIT development board
Package	DIP-20 (2.54 mm spacing pin header)
Dimension	30mm(W)*40mm(H) ±0.2 mm (PB-01-KIT) 30mm(W)*45.5mm(H) ±0.2 mm (PB-02-KIT)
Wireless standard	Bluetooth 5.0, support Mesh
Frequency range	2400~2483.5MHz
Transmit power	Maximum 10dBm
Receiving sensitivity	Minimum -93±2dBm
Interface	PWM/SPI/GPIO/ADC
Operating temperature	-40°C~85°C
Storage temperature	-40°C~125°C, <90%RH
Power supply range	Micro USB supply voltage 4.75V~5.25V, recommend 5.0V
Power consumption	Deep sleep mode :0.7 uA,IO interface wake-up (only module) shallow sleep mode :2 uA,RTC wake-up (only module)
	Full load mode (TX: 10dBm) : 25mA (only module) RX mode: 7mA (only module)
	Development Board PCB: 4mA

2. Electrical parameters

Electrical characteristics

Absolute maximum rating

Any excess of the following absolute maximum can cause chip damage

Name	Min.	Typ.	Max.	Unit
Micro USB supply voltage	4.75	5.0	5.25	V
Operating temperature	-40	4.75	+85	°C
Storage temperature	-40	5.0	+125	°C

Power consumption

Parameter Name	Typ.	Unit
Emission power (10dBm)	25	mA
Receiving Power	7	mA

Light-sleep	2	uA
Deep-sleep	0.7	uA

Note: The consumption is for module consumption only.

RF parameters

RF transmit power

Name	Min.	Typ.	Max.	Unit
Average power	-	8.5	10	dBm

Receiving sensitivity

Name	Min.	Typ.	Max.	Unit
Receiving sensitivity	-95	-93	-	dBm

3.Appearance dimensions

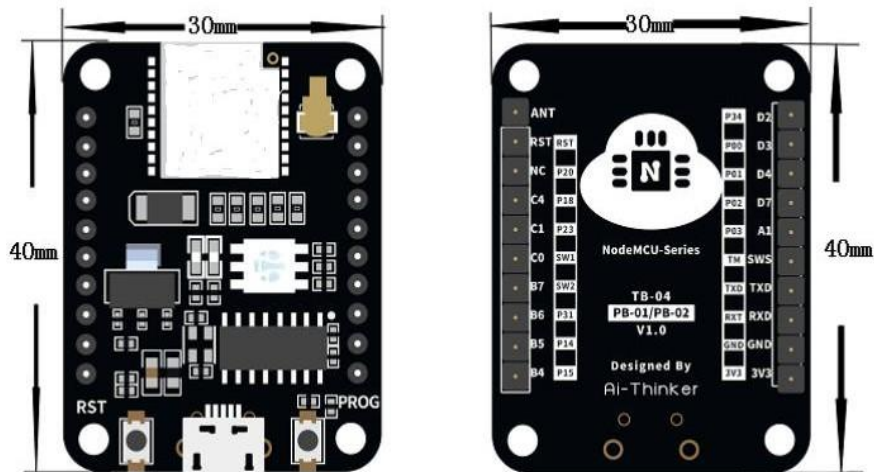

(PB-01-KIT dimension image)

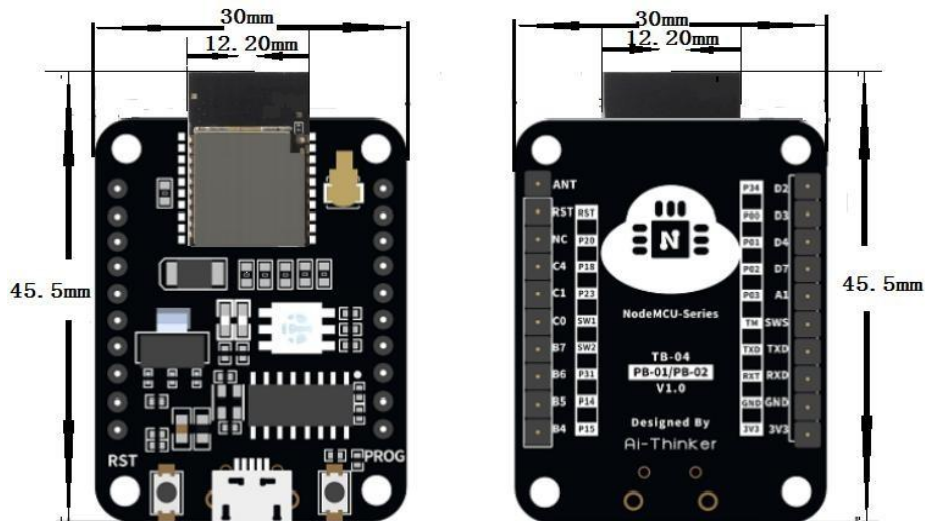

(PB-02-KIT dimension image)

4. Pin definitions

PB-01/02-KIT the development board module had lead out 20 interfaces, refer to below pin diagram, pin function definition table is interface definition.

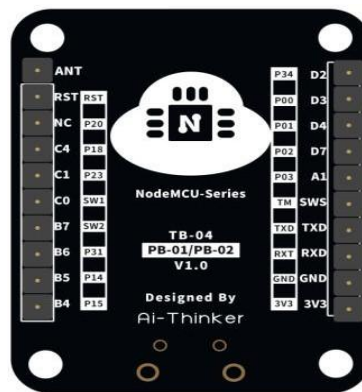

PB-01/PB-KIT pin diagram

Table Pin Definitions

No.	Pin name	Function
1	ANT	Antenna interface(note: PB-02 default to use on-board pcb antenna, no need for external antenna)
2	RST	Reset
3	P20	GPIO20, all functions can configure/ AIO /Microphone output *Note : Interrupt function not supported
4	P18	GPIO18, all functions can configure/ AIO / PGA Differential positive input *Note: Interrupt function not supported
5	P23	GPIO23, all functions can configure *Note : Interrupt and ADC function not supported.
6	SW1	GPIO24, all functions can configure/Test mode to start configure[0]
7	SW2	GPIO25, all functions can configure/Test mode to start configure[1], This pin high level pull up, boot into test mode

8	P31	GPIO31, all fuctions can configure *Note: Interrupt and ADC function not supported.
9	P14	GPIO14, all fuctions can configure/ AIO
10	P15	GPIO15, all fuctions can configure/ AIO
11	P34	GPIO34, all fuctions can configure *Note: Interrupt and ADC function not supported.
12	P00	GPIO00 , all fuctions can configure/ JTAG_TDO *Note : Interrupt and ADC function not supported.
13	P01	GPIO01, all fuctions can configure/ JTAG_TDI *Note: Interrupt and ADC function not supported.
14	P02	GPIO02 , all fuctions can configure/ JTAG_TMS *Note : Interrupt and ADC function not supported.
15	P03	GPIO03 , all fuctions can configure/ JTAG_TCK *Note : Interrupt and ADC function not supported.
16	TM	Choose burn mode, This pin high level pull up, boot into burn mode
17	TXD	Serial port URAT_TXD
18	RXD	Serial port URAT_RXD
19	GND	Ground
20	3V3	Power supply, typical value 3.3V

5.Schematics

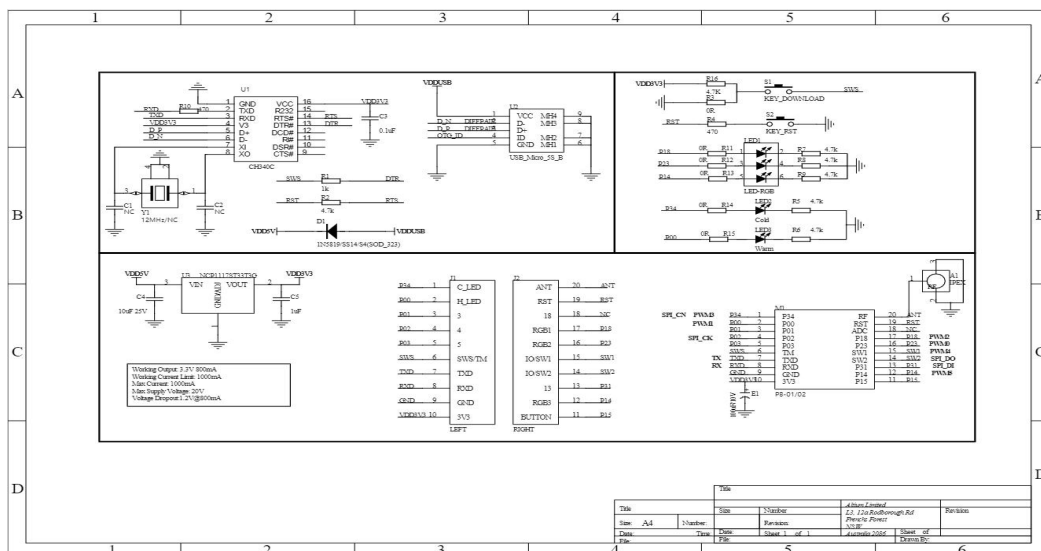

6.Design guidance

- 1、 Application circuit

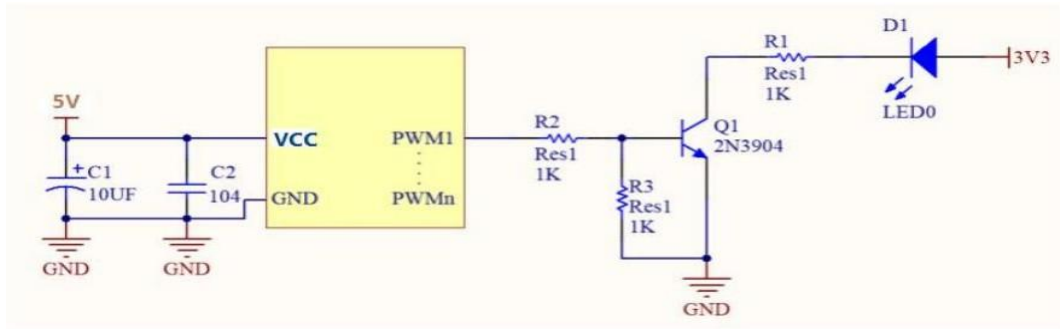

2、Antenna layout requirements

Do not place metal parts around the module antenna, away from high frequency devices.

3、Power supply

- (1) 、 Recommended voltage 5V, Peak:Current over 800mA .
- (2) 、 It is recommended to use the LDO power supply; If DC-DC is used, the ripple is controlled within 30 mV.
- (3) 、 DC-DC power supply circuit is recommended to reserve the position of the dynamic response capacitor, and the output ripple can be optimized when the load change is large.
- (4) 、 5V power interface proposed to add ESD devices.

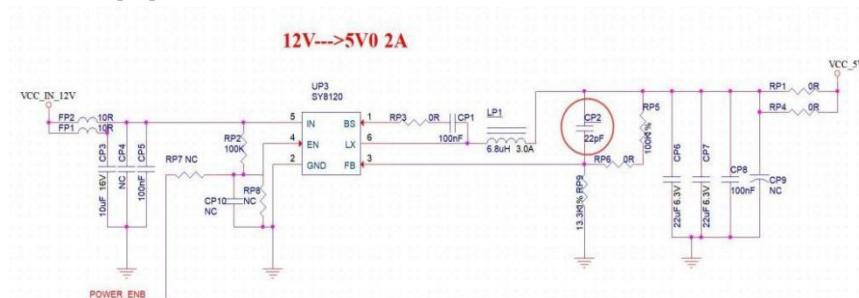

7.Reflow profile

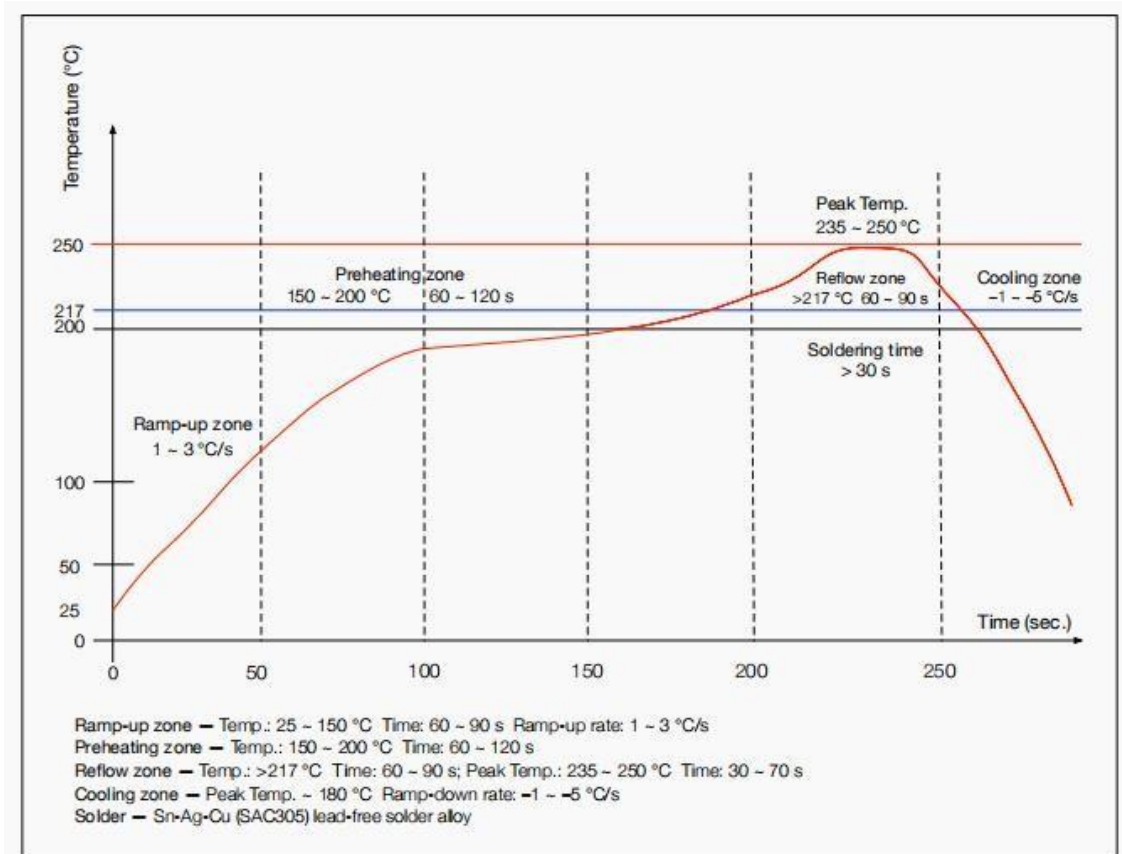

Figure 4: Reflow Profile

8.Package Information

PB-01/02-KIT is in anti-static bag package.

9.Contact us

Company website: <https://www.ai-thinker.com>

Developer Wiki: <https://docs.ai-thinker.com>

Company forum: <http://bbs.ai-thinker.com>

Sampling purchasing: <https://ai-thinker.en.alibaba.com>

Business cooperation: overseas@aithinker.com

Technology support: support@aithinker.com

Company address: Room410, Building C, Huafeng Intelligent Innovation Port, Xixiang, Baoan District, Shenzhen

Contacts: 0755-29162996

